



BROAN[®]

Attic Ventilation

Range Hoods

Ventilation Fans

Whole House Mechanical Ventilation

Customer Service 1-800-558-1711

Technical Support 1-800-637-1453

www.Broan.com

2019 LIST PRICES / FULL LINE PRODUCTS

NuTone[®]

Central Vacuum Systems

Door Chimes

Heaters

Ventilation Fans

Customer Service 1-888-336-3948

Technical Support 1-888-336-6151

www.NuTone.com

Effective Date: March 1, 2019
Supersedes all previous pricing

Download a copy of this price book at
www.broan.com/catalogs or www.nutone.com/catalogs



Accessories 1

Dampers	4
Ducting	5
Elbows	5
Hanger Bars	5
Replacement Parts	1
Roof Caps	3
Transitions	3
Wall Caps	4
Wall Controls	6

Attic Ventilators 7

Parts & Accessories	8
Roof Mount Powered	7
Gable Mount Powered	8
Solar Powered	7

Range Hoods 19

Accessories	47
Blowers	33
Chimney Hoods	19
Downdraft Hoods	26
High Performance Hoods	30
Power Packs	27
Under Cabinet Hoods	34

Trash Compactors 48

Accessories	48
-------------	----

Ventilation Fans 49

Bath Fan Upgrade Kit	68
Combination Units	72
Decorative Fan/Light	66
Duct Free	68
Economy	68
Heavy Duty Series	67
High Capacity	75
InVent	64
LED	66
LoProfile	67
Project Packs	69
Recessed Fan/Light	66
Remote In-Line	58
Room-to-Room	73
Sensing	62
Sensonic™	49 & 63
SmartSense®	49 & 63
Through the Wall	73
QT Series™	49 & 63
ULTRA™	61
Utility	74

Whole House Mechanical Ventilation 79

Accessories	82
Fresh Air Systems	79
Fresh In™ Supply Fans	81
ULTRA™	84
SmartSense®	79



Accessories 1

Dampers	4
Ducting	5
Elbows	5
Hanger Bars	5
Replacement Parts	1
Roof Caps	3
Transitions	3
Wall Caps	4

Central Vacuum Systems 9

Accessory Kits	10
Power Units	9

Door Chimes 13

Accessories	16
Chime Kits	14
Hard-Wired Chimes	13
Knock™ Smart Camera	14
Wireless Chimes	13
Wired Pushbuttons	15
Wireless Pushbuttons	16

Haven™ 16

Haven™ and Accessories	16
------------------------	----

Heaters 17

Accessories	18
Bulb	73
Fan-Forced	17
Kickspace	17
Project Packs	18
Register	18
Surface Mount	17
Wall	17

Ventilation Fans 49

Basic	53
Bath Fan Upgrade Kit	54
Bulb Heaters	65
Combination Units	59
Duct-Free	54
EZFit	53
In-Line Fans	58
InVent	51
LED Upgrade Grille	54
LoProfile	52
LunAura	50
Project Packs	55
Recessed Fan/Light	52
QT Series™	50 & 59
ULTRA™	49
Utility	60

Full Line Index

Model No.	List Price	Code	Page Number(s)
1006	\$20.24	CP	48
100HFL	\$381.18	LV	72
100HL	\$316.86	LV	72
103023	\$528.08	DH	28
103123	\$66.92	DH	28
110RDF	\$119.56	HV	67
112	\$291.82	HT	17
114	\$259.72	HT	17
120	\$179.20	HT	18
124	\$188.02	HT	18
128	\$193.72	HT	18
153001	\$1,010.08	DH	42
153004	\$1,049.62	DH	42
153023	\$1,010.08	DH	42
153601	\$1,092.04	DH	42
153604	\$1,132.58	DH	42
153623	\$1,092.04	DH	42
157	\$139.26	HT	17
15TCBB	\$170.10	CP	48
15TCBL	\$25.94	CP	48
15TCOD	\$55.44	CP	48
15CTK	\$24.52	CP	48
161	\$53.78	HV	73
162	\$112.12	HV	73
163	\$89.48	HV	73
164	\$149.60	HV	73
165FT	\$143.20	HT	18
1667HMTL	\$24.60	LV	71
1667H	\$10.38	LV	71
1670F	\$57.24	LV	71
1671F	\$51.46	LV	71
167FT	\$143.20	HT	18
1688F	\$36.60	LV	71
1689F	\$48.14	LV	71
170	\$179.20	HT	17
171H	\$35.94	HT	18
174FT	\$152.04	HT	18
174F	\$140.94	HT	18
174	\$188.02	HT	17
178	\$201.56	HT	17
192	\$439.70	HT	17
194	\$463.40	HT	17
198	\$485.48	HT	17
2677H	\$17.06	LV	70
2678F	\$84.14	LV	70
269VL	\$49.18	AC	6
269WL	\$49.18	AC	6
273001C	\$86.12	HA	26, 27
273002C	\$86.12	HA	26, 27
273003	\$1,079.00	DH	26
273023C	\$86.12	HA	26, 27
273601C	\$86.12	HA	26, 27
273602C	\$86.12	HA	26, 27
273603	\$1,079.00	DH	26
273623C	\$86.12	HA	26, 27
277V	\$95.26	AC	6, 78
283003	\$749.46	DH	27
283603	\$749.46	DH	27
326N	\$71.24	CA	10
330ALM	\$9.12	CA	10
330W	\$9.12	CA	10
331H	\$662.32	DH	33
332H	\$860.68	DH	33
332KR	\$113.58	HA	33
335	\$1,147.32	DH	33
336	\$1,432.28	DH	33

Model No.	List Price	Code	Page Number(s)
345SOBK	\$584.78	SO	7
345SOWW	\$584.78	SO	7
349BR	\$267.84	HV	7
350BK	\$231.78	HV	7
350BR	\$238.30	HV	7
35316	\$239.44	HV	8
353	\$158.36	HV	8
355BK	\$245.60	HV	7
355BR	\$252.14	HV	7
356BK	\$319.98	HV	7
356BR	\$326.54	HV	7
356NDK	\$118.30	HA	29
357NDK	\$144.90	HA	29
358NDK	\$115.40	HA	29
358	\$284.42	HV	7
359NDK	\$144.90	AC	28
35	\$31.04	AC	48
360ALM	\$21.42	CA	10
360NDK	\$146.20	HA	29
360W	\$21.42	CA	10
3677H	\$21.88	LV	70
372401	\$82.34	LL	46
372	\$118.92	CA	10
373001	\$77.80	LL	46
373004	\$138.32	LL	46
373601	\$82.34	LL	46
376UL	\$76.58	CA	10
3808	\$10.18	CA	10
3810	\$12.32	CA	10
391	\$12.32	CA	10
392	\$30.00	CA	10
393	\$33.22	CA	10
394	\$20.88	CA	10
395	\$88.92	CA	10
3964	\$116.24	CA	10
402101	\$162.24	LL	46
402102	\$162.24	LL	46
402108	\$162.24	LL	46
402401	\$136.54	LL	46
402402	\$136.54	LL	46
402404	\$197.10	LL	46
403001	\$131.98	LL	46
403002	\$131.98	LL	46
403004	\$192.52	LL	46
403023	\$131.98	LL	46
403601	\$136.54	LL	46
403602	\$136.54	LL	46
403604	\$197.10	LL	46
403623	\$136.54	LL	46
404201	\$141.02	LL	46
404202	\$141.02	LL	46
406	\$23.80	AC	5
407	\$24.56	AC	5
408	\$27.04	AC	5
410	\$31.70	AC	5
411	\$28.84	AC	3
412101	\$165.56	LL	47
412102	\$165.56	LL	47
412123	\$165.56	LL	47
412401	\$139.86	LL	47
412402	\$139.86	LL	47
412404	\$200.40	LL	47
412H	\$31.04	AC	3
413001	\$135.30	LL	47
413002	\$135.30	LL	47
413004	\$195.86	LL	47

Model No.	List Price	Code	Page Number(s)
413023	\$135.30	LL	47
413601	\$139.86	LL	47
413602	\$139.86	LL	47
413604	\$200.40	LL	47
413623	\$139.86	LL	47
413	\$35.26	AC	3
414201	\$144.40	LL	47
414202	\$144.40	LL	47
414204	\$204.94	LL	47
414	\$52.50	AC	3
415	\$18.44	AC	5
418	\$44.58	AC	3, 5
419	\$19.48	AC	5
41F	\$17.94	AC	2, 42, 44, 47
421	\$49.26	AC	4
422401D	\$139.40	LL	45
422401	\$128.80	LL	45
422402	\$128.80	LL	45
422404	\$189.36	LL	45
423001D	\$134.54	LL	45
423001	\$124.30	LL	45
423002	\$124.30	LL	45
423004	\$184.82	LL	45
423023	\$124.30	LL	45
423601D	\$139.40	LL	45
423601	\$128.80	LL	45
423602	\$128.80	LL	45
423604	\$189.36	LL	45
423608D	\$139.40	LL	45
423623	\$128.80	LL	45
423	\$73.38	AC	3, 76, 77, 78
424201D	\$144.00	LL	45
424201	\$133.36	LL	45
424202	\$133.36	LL	45
424204	\$193.86	LL	45
424	\$90.50	AC	3
427	\$78.64	AC	3
428	\$36.70	AC	5
429	\$49.26	AC	5
430	\$64.04	AC	5
431	\$64.28	AC	5
432	\$32.56	AC	5
433004	\$211.30	LL	43
433011	\$147.66	LL	43
433022	\$147.66	LL	43
433023	\$147.66	LL	43
433604	\$218.56	LL	43
433611	\$157.38	LL	43
433622	\$157.38	LL	43
433623	\$157.38	LL	43
433	\$85.50	AC	8
437	\$197.82	AC	3
438	\$42.46	AC	4
441	\$105.18	AC	4
453	\$106.36	AC	3
454	\$106.36	AC	3
459	\$47.92	AC	3
462401	\$206.12	RH	42
462404	\$266.68	RH	42
462423	\$206.12	RH	42
463001	\$196.30	RH	42
463002	\$196.30	RH	42
463004	\$256.84	RH	42
463008	\$196.30	RH	42
463011	\$196.30	RH	42
463023	\$196.30	RH	42

Model No.	List Price	Code	Page Number(s)
463601	\$206.12	RH	42
463602	\$206.12	RH	42
463604	\$266.68	RH	42
463623	\$206.12	RH	42
464201	\$216.02	RH	42
464202	\$216.02	RH	42
464204	\$276.54	RH	42
464208	\$216.02	RH	42
472	\$52.62	AC	4
475B	\$7.94	AC	3
475	\$10.82	AC	3
502	\$241.48	HV	74
503	\$160.34	HV	74
504	\$190.24	HV	74
505	\$136.64	HV	74
506	\$241.22	HV	74
507	\$196.18	HV	74
508	\$241.22	HV	74
509S	\$169.72	HV	74
509	\$160.52	HV	74
510	\$216.68	HV	73
511	\$173.60	HV	73
512M	\$109.52	HV	73
512	\$76.68	HV	73
57V	\$48.50	AC	6
57W	\$48.50	AC	6
59V	\$62.76	AC	6, 82
59W	\$62.76	AC	6, 82
605RP	\$225.22	LV	60
610FA	\$139.88	AC	4, 40
611CM	\$126.12	AC	3
611	\$95.18	AC	3
612CM	\$178.40	AC	3
612	\$163.20	AC	3
613004	\$2,294.68	DH	19
613	\$103.56	AC	4
614804EX	\$1,974.92	DH	19
614804	\$2,594.36	DH	19
619004EX	\$1,698.02	DH	19
619004	\$2,324.64	DH	19
61V	\$62.76	AC	6, 82
61W	\$62.76	AC	6, 82
62W	\$93.10	AC	6
634M	\$63.36	AC	3, 82
634	\$54.32	AC	3
636AL	\$40.28	AC	3
636	\$31.10	AC	3
637004EX	\$4,008.14	DH	19
637004	\$4,439.36	DH	19
639	\$36.60	AC	4
63V	\$83.14	AC	6
63W	\$83.14	AC	6
641FA	\$60.08	AC	4, 40
641	\$74.60	AC	4, 82
642	\$28.40	AC	4
643FA	\$88.30	AC	4, 40
643	\$94.00	AC	4
644	\$70.26	AC	3
646	\$50.54	AC	4
647	\$84.24	AC	4
649	\$47.34	AC	4
64V	\$120.48	AC	6
64W	\$120.48	AC	6
654H	\$27.72	LV	71
655F	\$199.44	LV	71
655	\$227.16	LV	72

Model No.	List Price	Code	Page Number(s)
656F	\$170.38	LV	71
656	\$198.08	LV	72
657F	\$122.04	LV	71
657	\$149.76	LV	72
658F	\$191.98	LV	71
658	\$219.72	LV	72
659F	\$196.26	LV	71
659	\$224.00	LV	72
665RP	\$227.16	LV	60
668RP	\$146.70	LV	53
66V	\$39.74	AC	6
66W	\$39.74	AC	6
670	\$67.62	LV	68
671	\$61.84	LV	68
673	\$61.72	LV	74
678	\$101.20	LV	68
682NT	\$70.32	LV	54
682	\$70.32	LV	68
688	\$46.98	LV	68
689	\$58.52	LV	68
68V	\$32.28	AC	6
68W	\$32.28	AC	6
690NT	\$62.12	UK	54
690RA	\$10.38	LV	57
690RMTLA	\$24.16	LV	57
690	\$62.12	UK	68
695RB	\$51.46	LV	57
695	\$61.84	LV	53
696N	\$46.98	LV	53
696RNB	\$36.60	LV	57
696	\$205.76	LV	72
69W	\$13.36	AC	6, 8
71V	\$66.10	AC	6, 8
72V	\$88.32	AC	6, 33
72W	\$88.32	AC	6, 33
73	\$46.64	AC	8
741SN	\$180.34	HV	66
744LEDNT	\$320.30	NF	52
744LED	\$320.30	NF	66
744NT	\$178.84	NF	52
744	\$178.84	NF	66
750	\$253.84	HV	67
751	\$228.84	HV	67
754RB	\$183.24	HV	66
75V	\$89.98	AC	6
761BN	\$196.98	HV	66
761RB	\$196.98	HV	66
761WHA	\$196.98	HV	66
763F	\$81.18	LV	57
763H	\$17.06	LV	57
763	\$98.24	LV	53
765HFL	\$381.18	LV	59
765HL	\$316.86	LV	59
77DV	\$46.38	AC	6, 59, 72
77DW	\$46.38	AC	6, 59, 72
791LEDM	\$262.46	HM	66
804DD	\$17.88	AC	4
804DU	\$74.48	AC	5
80L	\$53.02	AC	78
80RDF	\$113.60	HV	67
8210	\$176.68	HV	60
82W	\$105.36	AC	6, 82
8310	\$216.56	HV	60
834	\$20.08	AC	1
83	\$22.38	AC	18
843BL	\$57.22	AC	4

Model No.	List Price	Code	Page Number(s)
84	\$45.76	AC	18
854	\$24.46	AC	1
85	\$101.50	AC	18
8663RP	\$253.84	HV	53
8664RP	\$228.84	HV	53
877	\$33.42	AC	3
87W	\$32.38	AC	18
885AL	\$41.58	AC	4
885BL	\$32.84	AC	4
885NS	\$32.48	AC	4
889	\$30.50	AC	5
88F	\$33.26	AC	2
9093WH	\$431.28	HV	59
90	\$60.16	AC	6, 17, 18
9412D	\$53.78	HV	60
9417DN	\$112.12	HV	60
9422P	\$89.48	HV	60
9427P	\$149.60	HV	60
961L	\$32.54	AC	78
97	\$38.20	AC	4
9810WH	\$277.12	HT	17
9815WH	\$284.68	HT	17
981L	\$32.54	AC	78
982L	\$41.40	AC	78
983L	\$44.34	AC	78
A000HL	\$24.28	HM	69
A110F	\$149.08	HM	69
A110L	\$398.68	HM	65
A110	\$173.34	HM	65
A50L	\$150.80	HM	65
A70LF	\$128.28	HM	69
A70L	\$152.54	HM	65
A80F	\$131.74	HM	69
A80HDF	\$176.80	HM	69
A80HD	\$201.08	HM	65
A80L	\$364.00	HM	65
A80	\$156.00	HM	65
ACCGSEF2	\$41.40	GA	82
ACCGSFF2	\$41.38	GA	82
ACCGSFHP10	\$1,956.24	GA	82
ACCGSFHP2	\$206.44	GA	82
ACCGSFH	\$175.44	GA	82
ACCGSFP20	\$367.58	GA	82
ACCGSFP2	\$38.14	GA	82
ACCGSUHD	\$59.26	GA	83
AE110F	\$253.08	HM	69
AE110LF	\$351.36	HM	69
AE110L	\$450.68	HM	65
AE110SL	\$508.88	HM	64
AE110S	\$368.14	HM	64
AE110	\$277.34	HM	65
AE50F	\$149.08	HM	69
AE50	\$173.34	HM	65
AE60	\$841.78	AQ	79
AE80BF	\$97.08	HM	69
AE80BLF	\$201.06	HM	69
AE80BL	\$225.32	HM	65
AE80B	\$121.34	HM	65
AE80F	\$225.34	HM	69
AE80LF	\$391.74	HM	69
AE80L	\$416.00	HM	65
AE80SL	\$446.26	HM	64
AE80S	\$339.56	HM	64
AE80	\$249.60	HM	65
AEE60302SS	\$308.76	HA	30
AEE60362SS	\$320.68	HA	30

Model No.	List Price	Code	Page Number(s)
AEE60422SS	\$332.66	HA	30
AEE60482SS	\$344.66	HA	30
AEEP18SSE	\$345.30	OH	31
AEEP18SS	\$327.82	OH	31
AEEP2445SSE	\$901.52	OH	31
AEEP2445SS	\$868.72	OH	31
AEEP30SSE	\$450.22	OH	31
AEEP30SS	\$432.72	OH	31
AEEP6SSE	\$205.42	OH	31
AEEP6SS	\$189.48	OH	31
AEN110F	\$253.08	HM	55
AEN110L	\$450.68	HM	51
AEN110	\$277.34	HM	51
AEN50F	\$149.08	HM	55
AEN50	\$173.34	HM	51
AEN80BF	\$97.08	HM	55
AEN80BLF1	\$201.06	HM	55
AEN80BL	\$225.32	HM	51
AEN80B	\$121.34	HM	51
AEN80F	\$225.34	HM	55
AEN80LF	\$391.74	HM	55
AEN80L	\$416.00	HM	51
AEN80	\$249.60	HM	51
AN000HF	\$24.28	HM	55
AN000HL	\$24.28	HM	55
AN110F	\$149.08	HM	55
AN110L	\$398.68	HM	51
AN110	\$173.34	HM	51
AN70LF	\$128.28	HM	55
AN70L	\$152.54	HM	51
AN80HDF	\$176.80	HM	55
AN80L	\$364.00	HM	51
ANKE60302SS	\$356.88	HA	30, 32
ANKE60362SS	\$369.74	HA	30, 32
ANKE60422SS	\$461.46	HA	30, 32
ANKE60482SS	\$467.12	HA	30, 32
ARP310	\$50.66	AC	26, 27, 30, 32
ARP6	\$50.66	AC	19, 20, 22, 23, 27, 29
AWEPD36SS	\$398.86	OH	31
AWEPD42SS	\$424.54	OH	31
AWEPD48SS	\$450.22	OH	31
AWEPD60SS	\$483.08	OH	31
B12LCDARNW	\$7,888.56	AQ	79
B12LCDASNW	\$7,888.56	AQ	79
B12LCDHRNW	\$8,271.72	AQ	79
B12LCDHSNW	\$8,271.72	AQ	79
B12LCDPRNC	\$8,292.88	AQ	80
B12LCDPRNW	\$7,156.04	AQ	80
B12LCDPSNC	\$8,292.88	AQ	80
B12LCDPSNW	\$7,156.04	AQ	80
B12LCEARNW	\$7,416.58	AQ	80
B12LCEASNW	\$7,416.58	AQ	80
B12LCEHRNW	\$7,631.80	AQ	80
B12LCEHSNW	\$7,631.80	AQ	80
B12LCEPRNC	\$7,820.88	AQ	80
B12LCEPRNW	\$6,684.04	AQ	80
B12LCEPSNC	\$7,820.88	AQ	80
B12LCEPSNW	\$6,684.04	AQ	80
B1600705	\$7,467.30	AQ	80
B5330SS	\$906.96	DH	25
B5336SS	\$972.52	DH	25
B5630SS	\$957.46	DH	25
B5636SS	\$1,017.10	DH	25
B5730SS	\$1,029.24	DH	24
B5736SS	\$1,078.72	DH	24
B5830SS	\$949.38	DH	24

Model No.	List Price	Code	Page Number(s)
B5836SS	\$1,008.38	DH	24
B5936SS	\$1,561.46	DH	24
B6LCDARN	\$6,536.86	AQ	79
B6LCDASN	\$6,536.86	AQ	79
B6LCDHRN	\$6,921.02	AQ	79
B6LCDPRN	\$6,080.08	AQ	79
B6LCDPSN	\$6,080.08	AQ	79
B6LCEARN	\$5,222.38	AQ	79
B6LCEASN	\$5,222.38	AQ	79
B6LCEHRN	\$5,410.28	AQ	79
B6LCEHSN	\$5,410.28	AQ	79
B6LCEPRN	\$4,765.62	AQ	79
B6LCEPSN	\$4,765.62	AQ	79
BCDF130BLS	\$559.30	AH	36
BCDF130SS	\$459.38	AH	36
BCDF136BLS	\$574.74	AH	36
BCDF136SS	\$473.80	AH	36
BCDF142SS	\$490.28	AH	36
BCDJ130BL	\$566.50	AH	36
BCDJ130SS	\$613.88	AH	36
BCDJ130WH	\$567.54	AH	36
BCDJ136BL	\$582.98	AH	36
BCDJ136SS	\$628.30	AH	36
BCDJ136WH	\$582.98	AH	36
BCDJ142BL	\$613.88	AH	36
BCDJ142SS	\$659.20	AH	36
BCDJ142WH	\$613.88	AH	36
BCR1	\$91.30	QA	20, 21
BCSD124BL	\$244.12	AH	37
BCSD124SS	\$290.46	AH	37
BCSD124WW	\$244.12	AH	37
BCSD130BC	\$228.66	AH	37
BCSD130BL	\$228.66	AH	37
BCSD130SS	\$275.02	AH	37
BCSD130WW	\$228.66	AH	37
BCSD136BC	\$244.12	AH	37
BCSD136BL	\$244.12	AH	37
BCSD136WW	\$244.12	AH	37
BCSD142BL	\$259.56	AH	37
BCSD142SS	\$305.92	AH	37
BCSD142WW	\$259.56	AH	37
BCSEK130BL	\$290.46	AH	37
BCSEK130SL	\$336.82	AH	37
BCSEK130SS	\$336.82	AH	37
BCSEK130WW	\$290.46	AH	37
BD4	\$87.34	AC	5, 83
BD6	\$87.34	AC	5, 83
BK105	\$25.18	DC	14
BK110NBWH	\$33.42	DC	14
BK115LWH	\$36.70	DC	14
BK120NBWH	\$35.44	DC	14
BK125LWH	\$39.20	DC	14
BK131LPB	\$39.34	DC	14
BK131LRBZ	\$39.34	DC	14
BK131LSN	\$39.34	DC	14
BK144LCL	\$33.42	DC	14
BK147LWH	\$56.48	DC	14
BK240LWH	\$40.38	DC	14
BK240SLPB	\$43.12	DC	14
BK240SLSN	\$43.12	DC	14
BK242LWH	\$43.12	DC	14
BKDB130BL	\$383.16	AH	38
BKDB130SS	\$428.48	AH	38
BKDB130WW	\$383.16	AH	38
BKDB136BL	\$398.62	AH	38
BKDB136SS	\$443.94	AH	38

Model No.	List Price	Code	Page Number(s)
BKDB136WW	\$398.62	AH	38
BKDEG130BL	\$443.94	AH	38
BKDEG130SS	\$490.28	AH	38
BKDEG130WW	\$443.94	AH	38
BKSA130BL	\$213.22	AH	39
BKSA130SS	\$259.56	AH	39
BKSA130WW	\$213.22	AH	39
BKSH130BL	\$275.02	AH	39
BKSH130SS	\$321.36	AH	39
BKSH130WW	\$275.02	AH	39
BNDF130BL	\$826.06	AX	41
BNDF130SS	\$918.76	AX	41
BNDF130WW	\$826.06	AX	41
BNDF136BL	\$856.96	AX	41
BNDF136SS	\$949.66	AX	41
BNDF136WW	\$856.96	AX	41
BNDF142SS	\$1,011.46	AX	41
BNSC130BL	\$259.56	AX	41
BNSC130SS	\$305.90	AX	41
BNSC130WW	\$259.56	AX	41
BNSC136BL	\$275.02	AX	41
BNSC136SS	\$321.36	AX	41
BNSC136WW	\$275.02	AX	41
BP10	\$15.76	AC	2
BP11	\$17.66	AC	2
BP17	\$44.72	AC	2
BP18	\$44.72	AC	2
BP19	\$44.72	AC	2
BP20	\$7.82	AC	1
BP24	\$17.74	AC	1
BP25	\$11.36	AC	1
BP27	\$36.78	AC	1
BP28	\$37.54	AC	1
BP29	\$9.62	AC	2, 42, 44, 45, 46
BP2	\$17.66	AC	2
BP33	\$11.88	AC	1
BP34	\$11.88	AC	1
BP35	\$15.56	AC	1
BP36	\$14.90	AC	1
BP38	\$15.56	AC	1
BP436	\$7.24	AC	2
BP43	\$7.24	AC	2
BP46	\$6.30	AC	1
BP4	\$9.62	AC	2
BP50	\$26.72	AC	1
BP51	\$37.54	AC	1
BP52	\$49.08	AC	2
BP55	\$9.62	AC	2
BP56	\$17.66	AC	2
BP57	\$17.00	AC	2, 43
BP58	\$11.92	AC	2, 43
BP5	\$9.72	AC	2
BP7	\$9.72	AC	2
BP87Q	\$18.98	AC	2, 4, 34, 35, 36, 37, 38, 39, 40, 41, 44, 45
BP90	\$8.94	AC	1
BP91	\$19.22	AC	1
BPAPFA	\$53.16	AC	2
BPDP130SS	\$705.56	AH	40
BPDP136SS	\$721.00	AH	40
BPDP142SS	\$751.90	AH	40
BPDP148SS	\$782.80	AH	40
BPPF30	\$30.72	QA	2
BPPF36	\$33.20	QA	2
BPPF42	\$40.08	QA	2
BPPFA30	\$55.32	QA	2

Model No.	List Price	Code	Page Number(s)
BPPFA36	\$79.02	QA	2
BPODE30	\$59.56	AC	2
BPQTAF	\$9.68	AC	2
BPQTF	\$12.16	AC	2
BPRPFA	\$23.94	AC	2
BPS1FA30	\$28.42	AC	2
BPS1FA36	\$31.12	AC	2
BPS2FA30	\$41.66	AC	2
BPSF30	\$32.46	AC	2
BPSF36	\$34.72	AC	2
BQDD130BLS	\$590.20	AX	35
BQDD130BL	\$443.94	AX	35
BQDD130SS	\$490.28	AX	35
BQDD130WW	\$443.94	AX	35
BQDD136BLS	\$605.64	AX	35
BQDD136BL	\$459.38	AX	35
BQDD136SS	\$505.74	AX	35
BQDD136WW	\$459.38	AX	35
BQLA130BL	\$736.46	AX	34
BQLA130SS	\$782.80	AX	34
BQLA130WH	\$736.46	AX	34
BQLA136BL	\$751.90	AX	34
BQLA136SS	\$798.26	AX	34
BQLA136WH	\$751.90	AX	34
BQSJ130BL	\$290.46	AX	35
BQSJ130SS	\$336.82	AX	35
BQSJ130WW	\$290.46	AX	35
BQSJ136BL	\$305.92	AX	35
BQSJ136SS	\$352.26	AX	35
BQSJ136WW	\$305.92	AX	35
BW5030SS	\$736.46	DH	25
BW5036SS	\$770.44	DH	25
C350BN	\$36.36	AC	1
C350GN	\$10.80	AC	1
C370BN	\$51.96	AC	1
C905	\$17.78	DA	16
C907	\$28.18	DA	16
C909	\$31.38	DA	16
C915	\$28.18	DA	16
CA130	\$64.28	CA	10
CF329	\$6.42	CA	10
CF361F	\$20.88	CA	10
CF361	\$15.00	CA	10
CF362	\$3.22	CA	10
CF367	\$14.46	CA	10
CF368	\$1.84	CA	10
CF369	\$1.84	CA	10
CF372	\$6.42	CA	10
CF377	\$1.84	CA	10
CF380	\$1.08	CA	10
CF382S	\$1.70	CA	11
CF382	\$1.70	CA	10
CF383	\$2.36	CA	11
CF384	\$3.74	CA	11
CF385	\$1.60	CA	11
CF387	\$3.22	CA	11
CF388	\$1.08	CA	11
CF389	\$2.14	CA	11
CF3918	\$20.36	CA	11
CFT12WH	\$72.18	AC	6
CH230L	\$192.28	CA	11
CH235	\$155.86	CA	11
CH515	\$367.96	CA	11
CH615	\$367.96	CA	11
CI3303RK	\$125.34	CA	11
CI358W	\$24.64	CA	11

Model No.	List Price	Code	Page Number(s)
CI376W	\$13.06	CA	11
CI377W	\$85.70	CA	11
CI399ALM	\$10.72	CA	11
CI399EB	\$22.12	CA	11
CI399RK	\$31.08	CA	11
CI399W	\$10.72	CA	11
CK135	\$28.94	CA	12
CS100	\$133.92	CA	12
CS200	\$143.54	CA	12
CS300	\$412.42	CA	12
CS400	\$492.76	CA	12
CS500	\$889.10	CA	12
CS600	\$889.10	CA	12
CT105	\$4.82	CA	12
CT106G	\$6.96	CA	12
CT109	\$3.74	CA	12
CT110	\$3.74	CA	12
CT132	\$27.32	CA	12
CT140G	\$30.00	CA	12
CT143B	\$17.68	CA	12
CT150B	\$25.16	CA	12
CT156B	\$27.32	CA	12
CT157B	\$38.56	CA	12
CT158	\$45.00	CA	12
CT170	\$56.24	CA	12
CT175	\$56.24	CA	12
CT350B	\$41.78	CA	12
CT700	\$303.68	CA	12
CVG4	\$36.80	AC	1, 58
CVG6	\$49.46	AC	1, 58
CVL4	\$34.26	AC	1
CVL6	\$32.06	AC	1
CWT45	\$44.14	SO	7
D101	\$34.80	AC	78
DC4	\$7.82	AC	3
DCAM100FM	\$457.60	DC	14
DCAM100RB	\$41.60	DC	14
DCAM100	\$416.00	DC	14
DH100W	\$49.44	AC	8
DT4C	\$51.34	AC	83
DT4W	\$74.58	AC	83
DT6C	\$67.22	AC	83
DT6W	\$104.34	AC	5, 83
E050	\$36.94	LV	68
E070	\$49.50	LV	68
E0F50	\$28.36	LV	68
E0F70	\$40.90	LV	68
E5490SS	\$2,871.10	DH	22
E6030SS	\$1,964.86	DH	30
E6036SS	\$2,043.08	DH	30
E6042TSS	\$2,402.68	DH	30
E6048TSS	\$2,481.94	DH	30
E60E30SS	\$1,664.98	DH	30
E60E36SS	\$1,761.18	DH	30
E60E42SS	\$1,807.06	DH	30
E60E48SS	\$1,897.84	DH	30
E6430SS	\$1,306.48	DH	32
E6436SS	\$1,334.10	DH	32
E6442SS	\$1,434.88	DH	32
E6448SS	\$1,492.82	DH	32
E6448TSS	\$1,768.88	DH	32
E64E30SS	\$1,058.54	DH	32
E64E36SS	\$1,110.80	DH	32
E64E42SS	\$1,217.28	DH	32
E64E48SS	\$1,283.40	DH	32
EH6	\$79.76	AQ	83

Model No.	List Price	Code	Page Number(s)
EI5936SS	\$1,701.16	DH	20
EP300108	\$36.66	AC	47
EP300223	\$36.66	AC	47
EPD6136SS	\$2,513.28	OH	31
EPD6142SS	\$2,677.20	OH	31
EPD6148SS	\$2,841.10	OH	31
EPD6160SS	\$3,748.18	OH	31
EPLEC130SS	\$1,043.40	AH	40
EPLEC136SS	\$1,058.84	AH	40
EPLEC142SS	\$1,089.74	AH	40
EPLEC148SS	\$1,120.64	AH	40
EQLD130SS	\$998.08	AX	34
EQLD136SS	\$1,013.52	AX	34
ERV100SP	\$1,556.22	AQ	80
ERV100S	\$1,426.42	AQ	80
ERV110S	\$1,421.22	AQ	80
ERV110T	\$1,421.22	AQ	80
ERV120S	\$1,491.32	AQ	80
ERV120T	\$1,491.32	AQ	80
ERV130FLS	\$1,404.00	AQ	80
ERV140TE	\$2,594.56	AQ	80
ERV180S	\$1,945.60	AQ	80
ERV200TE	\$3,691.86	AQ	80
ERV250TE	\$3,115.00	AQ	80
ERV70S	\$1,296.64	AQ	80
ERV70T	\$1,296.64	AQ	80
ERVH100S	\$2,075.38	AQ	80
ERVS100S	\$1,106.56	AQ	80
EW5430BLS	\$1,305.02	DH	20
EW5436BLS	\$1,382.26	DH	20
EW5630SS	\$1,129.78	DH	21
EW5636SS	\$1,182.40	DH	21
EW5830SS	\$1,129.78	DH	21
EW5836SS	\$1,182.40	DH	21
EZ80N	\$246.06	HV	53
F402401	\$145.24	LL	44
F402404	\$206.48	LL	44
F402408	\$145.24	LL	44
F402411	\$145.24	LL	44
F402422	\$145.24	LL	44
F402423	\$145.24	LL	44
F403001	\$139.30	LL	44
F403004	\$198.02	LL	44
F403008	\$139.30	LL	44
F403011	\$139.30	LL	44
F403022	\$139.30	LL	44
F403023	\$139.30	LL	44
F403601	\$153.22	LL	44
F403604	\$217.82	LL	44
F403611	\$153.22	LL	44
F403622	\$153.22	LL	44
F403623	\$153.22	LL	44
F404201	\$168.52	LL	44
F404204	\$239.62	LL	44
F404208	\$168.52	LL	44
F404211	\$168.52	LL	44
F404222	\$168.52	LL	44
F404223	\$168.52	LL	44
FG500NS	\$46.94	AC	54
FG500N	\$46.94	AC	54
FILTER59	\$73.06	AC	24
FILTERE56FL	\$75.42	AC	21
FILTERE56	\$59.28	AC	2, 20, 21
FILTEREB40	\$96.22	HA	2, 23, 27
FILTERECM	\$48.58	AC	20
FILTER SQUARE	\$61.22	HA	2, 22, 23

Model No.	List Price	Code	Page Number(s)
FIN-180B	\$290.00	KS	81
FIN-180P	\$380.00	KS	81
FIN-MERV13	\$66.00	KS	83
FIN-MERV8	\$34.56	KS	83
FIN-R1015	\$50.00	KS	83
FX54SS	\$957.04	HA	22
FXE54BLS	\$459.38	AC	20
FXN53SS	\$268.80	HA	25
FXN54SS	\$957.04	HA	22
FXN56SS	\$298.14	AC	24, 25
FXN58SS	\$298.14	AC	24, 25
FXN59SS	\$336.98	AC	24
FXNE56SS	\$409.68	AC	21
FXNE58SS	\$293.40	AC	21
FXNE59SS	\$703.24	AC	20
FY6	\$48.04	AC	58
G102	\$155.56	AC	78
G103	\$200.44	AC	78
G686N	\$13.06	AC	1
GU1035	\$16.40	AC	20, 21, 48
GU10	\$17.58	AC	20, 27, 30, 31, 32, 48
HAWRK3	\$55.62	AC	34, 35, 36, 38, 40, 41
HCK44D	\$14.72	AC	48
HCK44	\$22.40	AC	48
HCR3	\$101.98	AC	34
HD50RDF	\$125.72	HV	67
HD80L	\$160.86	HV	67
HLB11	\$1,181.28	DH	33
HLB3	\$437.52	DH	33
HLB6	\$738.28	DH	33
HLB9	\$989.88	DH	33
HPF1	\$29.36	AC	39
HPF24	\$42.24	AC	37, 40
HPF30	\$44.80	AC	37
HPF30	\$44.80	AC	34, 35, 36, 37, 38, 39, 40, 41
HPF36	\$49.44	AC	34, 35, 36, 37, 38, 40, 41
HPF42	\$56.66	AC	36, 37, 40, 41
HPF52	\$49.44	AC	34
HPFA124	\$44.30	AC	37
HPFA130	\$48.42	AC	37
HPFA136	\$53.56	AC	37
HPFA142	\$61.80	AC	37
HPFA3A30	\$120.52	HA	35, 38, 41
HPFA3A36	\$139.06	HA	35
HPFA3B30	\$105.06	HA	36
HPFA3B36	\$120.52	HA	36
HPFA3B42	\$139.06	HA	36
HPFA424	\$122.58	HA	40
HPFA430	\$129.78	HA	34, 40
HPFA436	\$142.14	HA	34, 40
HPFA442	\$163.78	HA	40
HPFA52	\$52.54	AC	34
HPFAMM30	\$52.54	AC	35, 36, 38, 39, 41
HPFAMM36	\$58.72	AC	35, 36, 38, 41
HPFAMM42	\$66.96	AC	36, 41
HPFA	\$34.00	AC	39
HRKMBSL	\$278.10	AC	20
HRV120S	\$1,296.64	AQ	80
HRV120T	\$1,296.64	AQ	80
HRV130FLS	\$1,352.00	AQ	81
HRV150FLS	\$1,789.36	AQ	81
HRV150S	\$1,680.80	AQ	81
HRV160TE	\$1,945.60	AQ	81
HRV160T	\$1,615.92	AQ	81
HRV190FLS	\$2,142.40	AQ	81

Model No.	List Price	Code	Page Number(s)
HRV190S	\$1,945.60	AQ	81
HRV200TE	\$2,855.42	AQ	81
HRV250TE	\$2,999.66	AQ	81
HRV80S	\$1,067.40	AQ	80
HRV80T	\$1,067.40	AQ	80
HRV90S	\$1,200.58	AQ	80
HRV90T	\$1,200.58	AQ	80
HRVH100S	\$1,556.22	AQ	81
HVRC1	\$69.68	ML	16
HVRC4	\$214.24	ML	16
ILF120	\$333.78	HV	58
ILF130	\$349.66	HV	58
ILF250	\$365.56	HV	58
ILFK120	\$365.56	HV	58
ILFK130	\$381.48	HV	58
ILFK2502	\$476.84	HV	58
ILFK250	\$413.22	HV	58
ILRF	\$323.06	HV	58
L100L	\$273.32	HV	77
L100MG	\$280.72	HV	75
L100	\$253.30	HV	75
L1500L	\$885.64	HV	77
L1500	\$848.44	HV	76
L150L	\$281.92	HV	77
L150MG	\$289.32	HV	75
L150	\$261.84	HV	75
L2000L	\$1,270.66	HV	78
L200L	\$309.20	HV	77
L200MG	\$316.04	HV	75
L200	\$288.58	HV	75
L250L	\$326.24	HV	77
L250MG	\$333.10	HV	75
L250	\$305.68	HV	75
L300KMG	\$360.54	HV	75
L300L	\$332.92	HV	77
L300MG	\$339.74	HV	75
L300	\$312.30	HV	75
L3500EXL	\$1,758.92	HV	78
L400KL	\$491.88	HV	77
L400K	\$460.28	HV	76
L400L	\$454.70	HV	77
L400	\$423.18	HV	76
L500KL	\$580.88	HV	77
L500K	\$549.26	HV	76
L500L	\$543.78	HV	77
L500	\$512.20	HV	76
L700L	\$632.78	HV	77
L700	\$601.22	HV	76
L900L	\$796.64	HV	77
L900	\$759.36	HV	76
LA100WH	\$38.06	DC	13
LA107WH	\$100.24	DC	13
LA11BG	\$43.96	DC	13
LA11WH	\$43.96	DC	13
LA126WH	\$35.74	DC	13
LA130WH	\$65.20	DC	13
LA139WH	\$35.74	DC	13
LA140WH	\$35.74	DC	13
LA14WH	\$63.88	DC	13
LA174WH	\$138.94	DC	13
LA18WH	\$81.60	DC	13
LA202WH	\$55.22	DC	13
LA223WH	\$50.10	DC	13
LA224RWH	\$81.86	DC	13
LA224WH	\$91.70	DC	13
LA225WH	\$44.24	DC	13

Model No.	List Price	Code	Page Number(s)
LA226WH	\$67.78	DC	13
LA227WH	\$45.76	DC	14
LA305WL	\$365.68	DC	13
LA310CY	\$419.34	DC	13
LA39WH	\$169.36	DC	13
LA542WH	\$69.12	DC	13
LA552RW	\$85.68	DC	13
LA553WH	\$55.98	DC	13
LA600WH	\$102.82	DC	13
LA70MA	\$327.92	DC	13
LAF1	\$16.02	AC	78
LAF2	\$27.62	AC	78
LB30SS	\$106.20	HA	29
LB30	\$102.54	HA	28, 29
LB36SS	\$121.60	HA	29
LB36	\$113.48	HA	28, 29
LP110F	\$83.86	HV	69
LP110H	\$28.68	HV	69
LP110	\$107.26	HV	67
LP80F	\$81.00	HV	69
LP80H	\$25.84	HV	55, 69
LP80	\$103.50	HV	67
LPN80F	\$81.00	HV	55
LPN80	\$103.50	HV	52
LT30	\$102.54	HA	28, 29
LT36	\$113.48	HA	28, 29
MCB2	\$15.54	AC	53, 66, 67, 68
MCV309NWHGL	\$62.54	DC	13
MD10S	\$305.98	HA	4
MD10TU	\$360.60	HA	4, 20, 34, 40
MD10T	\$316.88	HA	4, 20, 21, 30, 32
MD6S	\$177.02	HA	4
MD6TU	\$251.32	HA	4, 20, 34, 40
MD6T	\$180.10	HA	4, 20, 21, 30, 32
MD8S	\$198.88	HA	4
MD8TU	\$273.18	HA	4, 20, 34, 40
MD8T	\$193.94	HA	4, 20, 21, 30, 32
MG1	\$38.44	AC	78
MHB4	\$20.80	AC	51, 65
MMDC4	\$26.00	AC	51, 65
MMG	\$45.08	AC	51, 65
MQF4	\$20.80	AC	51, 65
P57W	\$50.66	AC	7
P59V	\$81.24	AC	7
P59W	\$81.24	AC	7
P5	\$520.06	RH	33
P66V	\$42.32	AC	7
P66W	\$42.32	AC	7
P68W	\$34.82	AC	7
P8	\$948.30	RH	33
PAR20	\$23.90	AC	27, 48
PB15LBR	\$27.68	DA	15
PB15LSN	\$27.68	DA	15
PB18LWHCL	\$8.18	DA	15
PB18WHCL	\$5.20	DA	15
PB19LGL	\$21.00	DA	15
PB27LBR	\$27.68	DA	15
PB27LSN	\$27.68	DA	15
PB41APB41LA	\$3.60	DA	15
PB41BGL	\$7.52	DA	15
PB41LBGL	\$10.48	DA	15
PB41LBR	\$12.44	DA	15
PB41LSN	\$12.44	DA	15
PB4LBL	\$23.70	DA	15
PB4LBR	\$27.68	DA	15
PB4LSN	\$27.68	DA	15

Model No.	List Price	Code	Page Number(s)
PB53LWH	\$23.70	DA	15
PB61LPB	\$25.96	DA	15
PB64LAB	\$22.06	DA	15
PB69LBL	\$8.36	DA	15
PB69LSN	\$10.56	DA	15
PB78LWHCL	\$28.68	DA	16
PB7LBL	\$7.88	DA	15
PB7LPB	\$7.88	DA	15
PB7LSN	\$7.88	DA	15
PB7LWH	\$7.88	DA	15
PB7WH	\$7.88	DA	15
PB82WH	\$22.06	DC	16
PB85BR	\$38.30	DC	16
PB85SN	\$38.30	DC	16
PBL2	\$6.02	DA	16
PM250SSP	\$275.40	RH	29
PM250SSP	\$275.40	RH	29
PM250	\$199.40	RH	29
PM390SSP	\$460.00	RH	29
PM390	\$449.28	RH	29
PM500SS	\$785.06	DH	28
PME300	\$625.04	RH	29
PP500	\$664.14	CX	9
PP600	\$905.18	CX	9
PP650	\$1,205.12	CX	9
QT9093WH	\$527.94	HV	59
QTHB1	\$19.44	AC	5
QTNLEDA	\$440.24	NF	50
QTNLEDB	\$440.24	NF	50
QTX110HFLT	\$634.76	HV	72
QTX110HL	\$570.46	HV	72
QTXE080FLT	\$387.24	HV	64
QTXE080	\$262.78	HV	64
QTXE110FLT	\$428.70	HV	64
QTXE110S	\$416.64	HV	64
QTXE110	\$297.34	HV	64
QTXE150FLT	\$501.36	HV	64
QTXE150	\$356.16	HV	64
QTXEN080FLT	\$387.24	HV	50
QTXEN080	\$262.78	HV	50
QTXEN110FLT	\$428.70	HV	50
QTXEN110	\$297.34	HV	50
QTXEN150FLT	\$501.36	HV	50
QTXEN150	\$356.16	HV	50
QTXN110HFLT	\$634.76	HV	59
QTXN110HL	\$570.46	HV	59
RB110L1	\$424.80	HP	63
RB110	\$302.30	HP	63
RB80L1	\$398.32	HP	63
RB80	\$272.54	HP	63
RBFIP33	\$227.34	AC	27
RBFIP45	\$280.38	AC	27
RD1	\$177.90	AC	78
RD2	\$189.78	AC	78
RD3	\$237.26	AC	78
RDF1	\$126.08	HP	56, 70
RDFQF	\$126.08	HV	56, 70
RDFQL	\$126.08	HV	56, 70
RDFUWT	\$126.08	HP	56, 70
RDFU	\$126.08	HP	56, 70
RDH	\$144.32	HV	67
RDJ1	\$147.02	HV	56, 70
RDJUMPO	\$8.78	AC	56, 70
RDJUMPU	\$17.58	AC	56, 70
RDJUMPU1	\$17.58	AC	70
RDM1	\$173.34	HM	51, 65

Model No.	List Price	Code	Page Number(s)
RDMWT	\$173.34	HM	51, 65
RFTH95	\$23.20	AC	8
RFX5001	\$291.54	HA	23
RFX5004	\$291.54	HA	23
RFX5023	\$291.54	HA	23
RFX5104	\$291.54	HA	23
RFX5204	\$291.54	HA	22
RFX5304	\$300.24	HA	22
RFX6104EX	\$582.98	HA	19
RFX6104	\$524.68	HA	19
RFX6304EX	\$1,428.36	HA	19
RFXN5004	\$291.54	HA	23
RFXN5204	\$291.54	HA	22
RFXN5304	\$300.24	HA	22
RG4	\$37.06	AC	1
RK54	\$205.10	HA	22
RK56	\$149.06	AC	24, 25
RK58	\$149.06	AC	24, 25
RK59	\$170.14	AC	24
RKE56	\$230.18	AC	21
RKE58	\$230.18	AC	21
RKE59	\$230.18	AC	20
RM503001	\$1,005.70	DH	23
RM503004	\$1,005.70	DH	23
RM503023	\$1,005.70	DH	23
RM503601	\$1,098.96	DH	23
RM503604	\$1,098.96	DH	23
RM503623	\$1,098.96	DH	23
RM519004	\$1,326.32	DH	23
RM523004	\$1,244.74	DH	22
RM523604	\$1,326.32	DH	22
RM524204	\$1,498.32	DH	22
RM533004	\$1,244.74	DH	22
RM533604	\$1,326.32	DH	22
RM534204	\$1,498.32	DH	22
RM659004	\$3,060.78	DH	19
RMDD3004EX	\$1,413.78	DH	26
RMDD3004	\$1,766.54	DH	26
RMDD3604EX	\$1,451.64	DH	26
RMDD3604	\$1,816.06	DH	26
RMDD4804EX	\$1,647.04	DH	26
RMDD4804	\$1,996.76	DH	26
RMDDRBK	\$72.86	HA	26
RME5030SS	\$1,084.16	RH	23
RMIP33	\$799.88	DH	27
RMIP45	\$881.50	DH	27
RMIPWC	\$142.84	HA	27
RML3336S	\$323.22	HA	28
RML3342S	\$330.74	HA	28
RML4548S	\$349.48	HA	28
RML4554S	\$382.00	HA	28
RML4560S	\$387.24	HA	28
RML5230S	\$273.90	HA	28
RML7030L	\$292.74	HA	28
RML7030S	\$273.90	HA	28
RML7036L	\$330.74	HA	28
RML7036S	\$323.22	HA	28
RML7048L	\$405.24	HA	28
RML7048S	\$349.48	HA	28
RMP17004	\$1,107.72	DH	27
RMP3004	\$553.18	HA	32
RMP3604	\$592.06	HA	32
RMP4204	\$630.86	HA	32
RMP4804	\$669.70	HA	32
RMP5404	\$708.64	HA	32
RMP6004	\$747.42	HA	32

Model No.	List Price	Code	Page Number(s)
RMPE7004	\$787.04	DH	27
RN110L	\$424.80	HP	49
RN110	\$302.30	HP	49
RN80L	\$398.32	HP	49
RN80	\$272.54	HP	49
ROUNDFILTER	\$100.06	HA	2, 19, 24, 25
RRK51	\$151.58	HA	22, 23
RVK1A	\$74.58	AC	3
S97011308	\$47.88	PT	67
S97013825	\$48.94	PT	75
S97013826	\$37.24	PT	75
S97013827	\$54.02	PT	75
S99010042	\$10.98	PT	75
S99010271	\$13.70	PT	75
S990712044	\$1.90	PT	6
SMD6	\$292.62	HA	4, 79
SMD8	\$308.00	HA	4, 79
SMSCPLR	\$47.74	AR	49, 79
SP240108	\$40.46	AC	47
SP240223	\$40.46	AC	47
SP2404	\$102.80	AC	47
SP300108	\$40.46	AC	47
SP300223	\$40.46	AC	47
SP3004	\$102.80	AC	47
SP360108	\$47.12	AC	47
SP360223	\$47.12	AC	47
SP3604	\$109.22	AC	47
SP420108	\$54.74	AC	47
SP420223	\$54.74	AC	47
SP4204	\$126.72	AC	47
SPB18LWHCL	\$8.36	PT	16
SPK110	\$410.64	HV	49, 63
SPKACC	\$189.26	AC	49, 63
SSQTXE080	\$298.54	HV	49, 63, 79
SSQTXE110	\$331.60	HV	49, 63, 79
T457	\$26.78	AC	3, 45
T460	\$35.94	AC	3
T461	\$46.60	AC	3
T486	\$32.56	AC	3
T487	\$34.32	AC	3
T81212	\$74.46	AC	3, 76, 77, 78
V104	\$24.84	AC	78
V14695	\$315.04	AQ	83
V21030	\$20.58	AQ	83
V21996	\$105.40	AQ	83
V22528	\$105.40	AQ	83
V61239	\$55.18	AQ	83
VACCWМК	\$72.82	AQ	83
VB20W	\$32.92	AQ	83
VS63WH	\$70.72	AC	6
VS66WH	\$90.36	AC	6
VS68WH	\$90.36	AC	6
VT10W	\$306.82	AQ	83
VT11W	\$31.66	KS	83
VT1W	\$63.60	AQ	83
VT4W	\$88.38	AQ	83
VT6W	\$59.40	AQ	83
VT7W	\$174.54	AQ	83
VT8W	\$282.84	AQ	83
VT9W	\$216.32	AQ	83
VTYIK1	\$130.50	AQ	83
VX1000C	\$1,553.24	CX	9
VX1000	\$1,553.24	CX	9
VX3916	\$19.26	XH	12
VX3918STD	\$19.74	XH	12
VX3918	\$77.40	XH	12

Model No.	List Price	Code	Page Number(s)
WC638	\$97.86	AC	5
WC650	\$21.82	AC	5
WVK2A	\$36.34	AC	5
XB110HL1	\$544.58	HP	62
XB110H	\$420.66	HP	62
XB110L1	\$433.18	HP	61
XB110	\$313.56	HP	61
XB50L1	\$388.86	HP	61
XB50	\$275.40	HP	61
XB80L1	\$419.26	HP	61
XB80	\$292.38	HP	61

Model No.	List Price	Code	Page Number(s)
ZB110HL1	\$593.52	HP	62, 84
ZB110H	\$466.78	HP	62, 84
ZB110L1	\$472.96	HP	61, 84
ZB110ML1	\$532.28	HP	62, 84
ZB110M	\$399.08	HP	62, 84
ZB110	\$351.18	HP	61, 84
ZB80L1	\$440.62	HP	61, 84
ZB80ML1	\$497.52	HP	62, 84
ZB80M	\$371.04	HP	62, 84
ZB80	\$321.30	HP	61, 84

Broan – NuTone Fan Replacement Parts

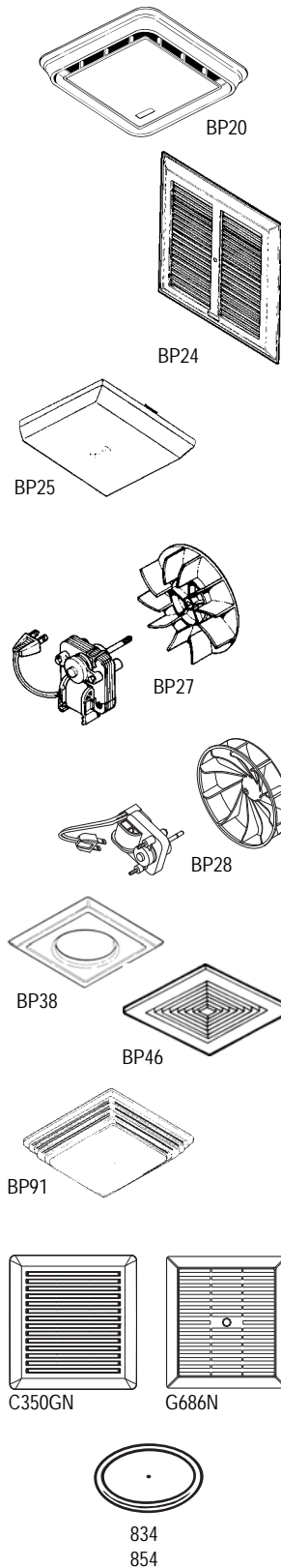

Model No.	Description	Std. Pk.	List Price	Code
BP20	Grille — Bath Fan (663, 670, 671, 675, 688 and 689)	6 *	\$7.82	AC
BP24	Grille — Bath Fan (Metal) (660, 662, 664, 665, 666 and 668)	15 *	\$17.74	AC
BP25	Light Lens — Fan/Light (678, 679, 679FL, 655, 656, 657, 659, 695 and 696)	6 *	\$11.36	AC
BP27	50 CFM Bath Fan Motor and Blower Wheel — Compatible with Broan 662, 668, 678-A, B, C, D, E, F and 688-A, B, C, D, E; Nautilus N678-A, B, C, D, E and N688-A, B, C	6 *	\$36.78	AC
BP28	Motor/Wheel — 70 CFM (655, 657, 658, 679, 671 and 671-A)	6 *	\$37.54	AC
BP33	Grille — Spring-Mounted (AC2650, AC2660, AC2900, 7550 and 7650)	6 *	\$11.88	AC
BP34	Grille — Center Screw-Mounted (Aubrey 7570)	6 *	\$11.88	AC
BP35	Grille/Knob — Utility Fan (8")	12 *	\$15.56	AC
BP36	Light Lens (AC2550, AC25501C and 682L)	5 *	\$14.90	AC
BP38	Grille — Single Bulb Heater	10 *	\$15.56	AC
BP46	Grille Assembly — Spring-Mounted (663, 670, 671, 675, 688, 689, Sears and others)	12 *	\$6.30	AC
BP50	Motor/Wheel — 50 CFM (663N, 663LN, and 696N ver. A)	6 *	\$26.72	AC
BP51	Motor/Wheel — 70 CFM (694 and 695 ver. A)	6 *	\$37.54	AC
BP90	Replacement Grille for 688 Fan	4 *	\$8.94	AC
BP91	Replacement Grille and Light Lens — Each grille and light lens is individually poly bagged and labeled with installation guide. Grille and Light Lens — Fits Fan/Light for Broan 678, 679, 679FL, 679FLT, 680, 680FL, 680FLT, HD50L, HD80L, FL2679FT and FL2680FT; NuTone HD50LNT and HD80LNT; Nautilus N678, N679, N679FL and N680. Light Lens Only — Broan 655, 656, 657, 659, 695, 696 and 707; Nautilus N707.	4 *	\$19.22	AC
C350BN	50 CFM Replacement Motor/Wheel (NuTone 696N A housing)	1	\$36.36	AC
C350GN	Grille — NuTone 695 and 696N with 8" x 7-1/4" housing	4 *	\$10.80	AC
C370BN	70 CFM Replacement Motor/Wheel (NuTone 695 A housing)	1	\$51.96	AC
CVG4	4" Grille	1	\$36.80	AC
CVG6	6" Grille	1	\$49.46	AC
CVL4	4" Sleeve	1	\$34.26	AC
CVL6	6" Sleeve	1	\$32.06	AC
G686N	Grille for NuTone 686	4 *	\$13.06	AC
RG4	Grille for NuTone 8832SA	12 *	\$37.06	AC
834	Filter for 8" Exhaust Fans (807C, 821C, 822C and 831C)	1	\$20.08	AC
854	Filter for 10" Exhaust Fans	6 *	\$24.46	AC

For model specific information, please refer to Broan Retail Parts publication (No. 99850402).

● Item too large to ship via UPS/FedEx. Item shipped common carrier at minimum rates.
 * All pricing reflects the individual item cost. You must order in multiples as indicated.
 ◆ UL listed for use over bathtubs and showers when connected to a GFCI protected branch circuit.

Broan – NuTone Hood Replacement Parts

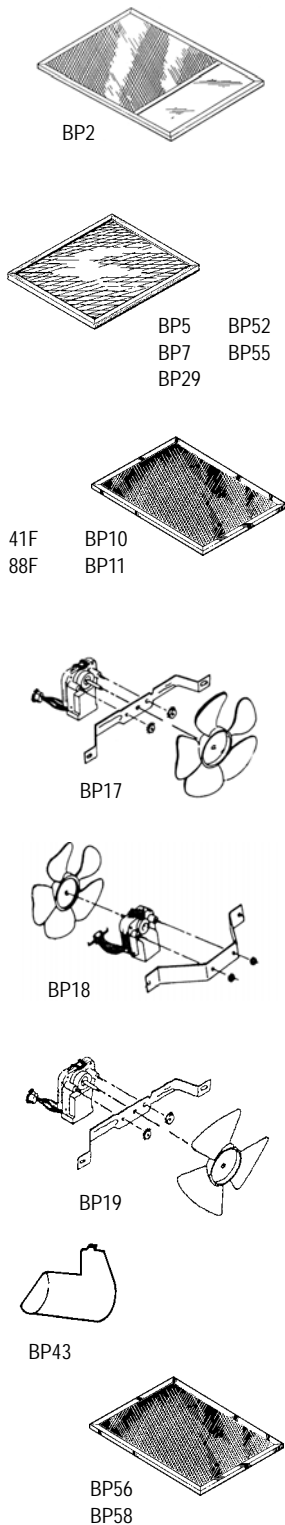

Model No.	Description	Std. Pk.	List Price	Code
BP2	Aluminum Filter with Light Lens (10-1/8" x 16-9/16")	12 *	\$17.66	AC
BP4	Aluminum Filter (10-1/2" Diameter)	12 *	\$9.62	AC
BP5	Aluminum Filter (8-5/8" x 11")	4 *	\$9.72	AC
BP7	Aluminum Filter (10-3/8" x 11-3/8")	8 *	\$9.72	AC
BP10	Non-ducted Filter (8" x 9-1/2")	8 *	\$15.76	AC
BP11	Non-ducted Filter (8-5/8" x 10")	8 *	\$17.66	AC
BP17	Fan Assembly — Hood (40000 Series)	4 *	\$44.72	AC
BP18	Fan Assembly — Hood (42000 Series)	4 *	\$44.72	AC
BP19	Fan Assembly — Hood (41000 Series)	4 *	\$44.72	AC
BP29	Aluminum Filter (8-3/4" x 10-1/2")	6 *	\$9.62	AC
BP43	Light Lens — Hood (40000, 41000, 42000 and others) in display box	12 *	\$7.24	AC
BP436	Light Lens — Hood (40000, 41000, 42000 and others) in standard carton	6 *	\$7.24	AC
BP52	Motor/Blade (M2T, MK2T, M4T, V20, V25, V26 and V26N)	4 *	\$49.08	AC
BP55	Aluminum Filter (8" x 9-1/2")	8 *	\$9.62	AC
BP56	Non-ducted Filter (8" x 9-1/2")	8 *	\$17.66	AC
BP57	11-3/8" x 11-3/4" Washable Aluminum and Charcoal Filter with light lens. Master pack contains 8 filters. (SR610050 — Single Pack.)	8 *	\$17.00	AC
BP58	Replacement Charcoal Filter Pack. Each pack contains three 7-3/4" x 10-1/2" pads. Master pack contains 8 filter packs. (SR610051 — Single Pack)	8 *	\$11.92	AC
BP87Q	7" Damper for round discharge range hood. (S97018803 — Single Pack)	3 *	\$18.98	AC
BPAPFA	Replacement grease filters with antimicrobial protection (3 Pack/2 Filters per Pack)	3 *	\$53.16	AC
BPPF30	Non-duct Filters for QP130, QP230 and QP330	6 *	\$30.72	QA
BPPF36	Non-duct Filters for QP136, QP236 and QP336	3 *	\$33.20	QA
BPPF42	Non-duct Filter for QP142, QP242 and QP342	1	\$40.08	QA
BPPFA30	Replacement QP130 aluminum grease filters	3 *	\$55.32	QA
BPPFA36	Replacement QP136 aluminum grease filters	3 *	\$79.02	QA
BPODE30	Aluminum replacement grease filters for QDE30 Series (3 Pack)	3 *	\$59.56	AC
BPQTAF	Aluminum Grease Filters (99010316 — Single Pack)	4 *	\$9.68	AC
BPQTF	Non-ducted Filters (99010317 — Single Pack)	4 *	\$12.16	AC
BPRPFA	Replacement grease filters (3 Pack/2 Filters per Pack) (S97017455 — Single Pack)	3 *	\$23.94	AC
BPS1FA30	Aluminum Replacement Range Hood Filters for use with 30" QS I and WS I Series Allure Hoods. Each pack contains 2 filters.	3 *	\$28.42	AC
BPS1FA36	Aluminum Replacement Range Hood Filters for use with 36" QS I and WS I Series Allure Hoods. Each pack contains 2 filters.	3 *	\$31.12	AC
BPS2FA30	Aluminum Replacement Range Hood Filters for use with 30" QS II and WS II Series Allure Hoods. Each pack contains 2 filters.	6 *	\$41.66	AC
BPSF30	Range Hood Filters for non-duct 30" QS and WS Series Allure Hoods. Each pack contains 2 filters.	4 *	\$32.46	AC
BPSF36	Range Hood Filters for non-duct 36" QS and WS Series Allure Hoods. Each pack contains 2 filters.	4 *	\$34.72	AC
FILTERE56	Non-ducted Filter	1	\$59.28	AC
FILTEREB40	Replacement non-ducted charcoal filter for RMP17004 and RM50000	1	\$96.22	HA
FILTER SQUARE	Replacement non-ducted charcoal filter	1	\$61.22	HA
ROUND FILTER	Replacement non-ducted charcoal filter (for 613004 and 619004)	1	\$100.06	HA
41F	Replacement non-ducted filters for 11000, 41000, 46000, ACS, F40000, RL6200, RL6200FH, SL6200H and SM6500R	6 *	\$17.94	AC
88F	Replacement non-ducted filter for 88000, AP1 and RP2 Series. Master Pack contains 6 pairs of filters (S97007662 — Single Pack).	6 *	\$33.26	AC

■ Limited quantities available.

● Item too large to ship via UPS/FedEx. Item shipped common carrier at minimum rates.
 * All pricing reflects the individual item cost. You must order in multiples as indicated.
 ◆ UL listed for use over bathtubs and showers when connected to a GFCI protected branch circuit.

Accessories — Hood and Fan

Broan – NuTone Roof Caps

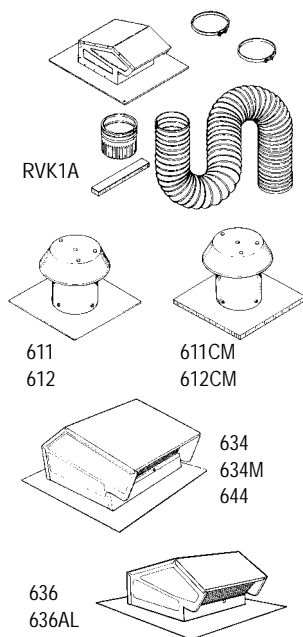

Model No.	Description	Std. Pk.	List Price	Code
437	High Capacity Roof Cap — up to 1200 CFM. Black.	1	\$197.82	AC
611	Aluminum Roof Cap for flat roofs. Up to 8" round duct. Natural finish.	1	\$95.18	AC
611CM	Aluminum Roof Cap for flat roofs. For curb mount installation. Up to 8" round duct. Natural finish.	1	\$126.12	AC
612	Aluminum Roof Cap for flat roofs. Up to 12" round duct. Natural finish.	1	\$163.20	AC
612CM	Aluminum Roof Cap for flat roofs. For curb mount installation. Up to 12" round duct. Natural finish.	1	\$178.40	AC
634	Steel Roof Cap for 3-1/4" x 10" or up to 8" round duct. Black.	1	\$54.32	AC
634M	Steel Roof Cap for 6" round duct. Includes damper and birdscreen. Black. (Not recommended for range hoods.)	1	\$63.36	AC
636	Steel Roof Cap for 3" or 4" round duct. Black.	1	\$31.10	AC
636AL	Same as Model 636 except aluminum. Natural finish.	1	\$40.28	AC
644	Same as Model 634 except aluminum. Natural finish.	1	\$70.26	AC
DC4	4" Duct Collar. For use with Models 636/636AL for easy attachment of 4" round duct.	6 *	\$7.82	AC
RVK1A	Roof Vent Kit, 8' of 4" flexible aluminum duct. Model 636 Roof Cap, 4" to 3" reducer, 4" dia. connector, (2) 4" dia. clamps.	1	\$74.58	AC

Broan – NuTone Transitions

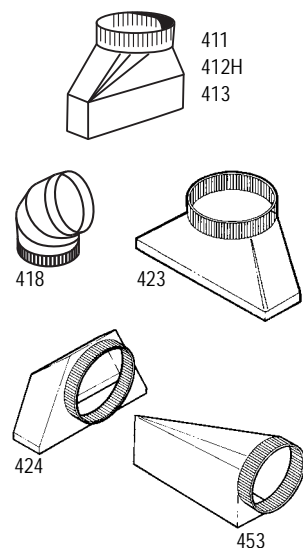

Model No.	Description	Std. Pk.	List Price	Code
411	3-1/4" x 10" to 6" Round Transition	1	\$28.84	AC
412H	3-1/4" x 10" to 7" Round Transition	1	\$31.04	AC
413	3-1/4" x 10" to 8" Round Transition	1	\$35.26	AC
414	8" to 10" Expander	1	\$52.50	AC
418	10" Adjustable Elbow	1	\$44.58	AC
423	Vertical Transition — 4-1/2" x 18-1/2" to 10" round	1	\$73.38	AC
424	■ Rear Transition — 4-1/2" x 18-1/2" to 10" round	1	\$90.50	AC
427	4-1/2" x 18-1/2" to 10" Round Transition (thin wall)	1	\$78.64	AC
453	■ Horizontal Left Transition — 4-1/2" x 18-1/2" to 10" round (right end boot)	1	\$106.36	AC
454	■ Horizontal Right Transition — 4-1/2" x 18-1/2" to 10" round (left end boot)	1	\$106.36	AC
459	■ 3-1/4" x 14" to 8" Round Transition	1	\$47.92	AC
475	6" to 4" duct reducer (Single pack)	1	\$10.82	AC
475B	6" to 4" duct reducer (6 pack)	6 *	\$7.94	AC
877	6" to 3-1/4" x 10"	1	\$33.42	AC
T457	7" to 5" duct reducer	1	\$26.78	AC
T460	Transition; 3-1/4" x 14" to 7" Round	1	\$35.94	AC
T461	Adapter, 3-1/4" x 14" to 3-1/4" x 10"	1	\$46.60	AC
T486	8" to 6" duct reducer	1	\$32.56	AC
T487	8" to 7" duct reducer	1	\$34.32	AC
T81212	Duct Transition — 8" x 12" to 12" rd. for 900 & 1500 CFM models	1	\$74.46	AC

■ Limited quantities available.

● Item too large to ship via UPS/FedEx. Item shipped common carrier at minimum rates.
 * All pricing reflects the individual item cost. You must order in multiples as indicated.
 ◆ UL listed for use over bathtubs and showers when connected to a GFCI protected branch circuit.

Accessories — Hood and Fan

Broan – NuTone Dampers

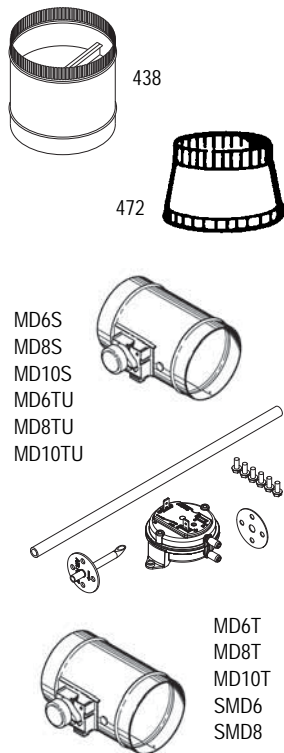

Model No.	Description	Std. Pk.	List Price	Code
97	7" Spring-loaded Damper	1	\$38.20	AC
421	10" Vertical discharge in-line damper	1	\$49.26	AC
438	8" Horizontal or vertical discharge in-line damper	1	\$42.46	AC
472	10" to 8" Reducer-damper, use with Model 504 (includes damper)	1	\$52.62	AC
804DD	4" Diameter Galvanized Metal Duct Collar with Damper	1	\$17.88	AC
BP87Q	7" Damper for round discharge range hood. (S97018803 — Single Pack)	3 *	\$18.98	AC
MD6S	6" Make-up air slave damper (Damper Only)	1	\$177.02	HA
MD6T	6" Automatic make-up air damper	1	\$180.10	HA
MD6TU	6" Universal automatic make-up air damper with pressure sensor kit. Also works with ULTRA and QT Series fans if at least 80 CFM and used with 6" rigid duct.	1	\$251.32	HA
MD8S	8" Make-up air slave damper (Damper Only)	1	\$198.88	HA
MD8T	8" Automatic make-up air damper	1	\$193.94	HA
MD8TU	8" Universal automatic make-up air damper with pressure sensor kit	1	\$273.18	HA
MD10S	10" Make-up air slave damper (Damper Only)	1	\$305.98	HA
MD10T	10" Automatic make-up air damper	1	\$316.88	HA
MD10TU	10" Universal automatic make-up air damper with pressure sensor kit	1	\$360.60	HA
SMD6	6" LinkLogic automatic make-up air damper	1	\$292.62	HA
SMD8	8" LinkLogic automatic make-up air damper	1	\$308.00	HA

■ Limited quantities available.

Broan – NuTone Wall Caps

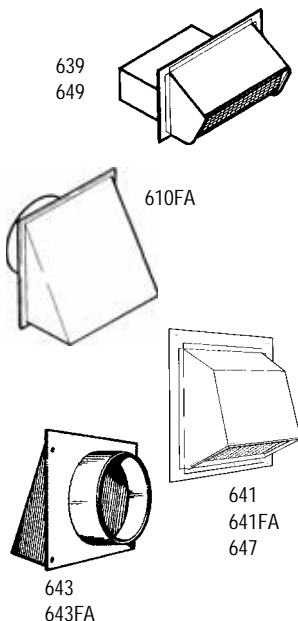

Model No.	Description	Std. Pk.	List Price	Code
441	Aluminum Wall Cap with gravity damper for 10" round duct	1	\$105.18	AC
610FA	10" Aluminum Fresh Air Inlet Wall Cap	1	\$139.88	AC
613	Aluminum Wall Cap for 12" round duct. Natural finish.	1	\$103.56	AC
639	Steel Wall Cap for 3-1/4" x 10" duct. Black.	1	\$36.60	AC
641	Aluminum Wall Cap for 6" round duct (includes damper and birdscreen). Natural finish.	1	\$74.60	AC
641FA	Aluminum Fresh Air Inlet Wall Cap for 6" round duct	1	\$60.08	AC
642	4" Round Aluminum Wall Cap	4 *	\$28.40	AC
643	Aluminum Wall Cap for 8" round duct. Natural finish.	1	\$94.00	AC
643FA	Aluminum Fresh Air Inlet Wall Cap for 8" round duct	1	\$88.30	AC
646	Plastic Louvered Wall Cap for 6" duct. White.	1	\$50.54	AC
647	Wall Cap. Same as Model 641 except for 7" round duct.	1	\$84.24	AC
649	Wall Cap. Same as Model 639 except aluminum. Natural finish.	1	\$47.34	AC
843BL	Wall Cap (black) for 6" round duct	1	\$57.22	AC
885AL	Wall Cap (aluminum) for 3" and 4" round duct	6 *	\$41.58	AC
885BL	Wall Cap (steel — black finish) for 3" and 4" round duct	6 *	\$32.84	AC
885NS	Wall Cap for 3" and 4" round duct (no birdscreen). Steel - black finish.	6 *	\$32.48	AC

● Item too large to ship via UPS/FedEx. Item shipped common carrier at minimum rates.

* All pricing reflects the individual item cost. You must order in multiples as indicated.

◆ UL listed for use over bathtubs and showers when connected to a GFCI protected branch circuit.

Accessories — Hood and Fan

Broan – NuTone Wall Caps CONTINUED

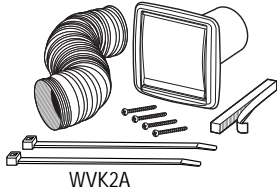

Model No.	Description	Std. Pk.	List Price	Code
BD4	Pressure Relief Damper with Wall Cap and 4" collar.	1	\$87.34	AC
BD6	Pressure Relief Damper with Wall Cap and 6" collar.	1	\$87.34	AC
WC638	Wall Cap — 3-1/4" x 14", Black.	1	\$97.86	AC
WC650	4" Wall Cap for 4" round duct. Includes 4" diameter metal duct connector and four mounting screws.	4 *	\$21.82	AC
WVK2A	Wall Ducting Kit — 5' of 4" diameter flexible foil duct, white wall cap for 4" round duct, 3" to 4" duct adapter, 2 nylon zip ties and mounting screws.	1	\$36.34	AC

Broan – NuTone 24" Duct Sections

Prices shown are for one complete 2' section.

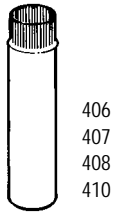

Model No.	Description	Std. Pk.	List Price	Code
406	6" Round Duct	5 *	\$23.80	AC
407	7" Round Duct	5 *	\$24.56	AC
408	8" Round Duct	1	\$27.04	AC
410	10" Round Duct	5 *	\$31.70	AC
804DU	4" Insulated Flexible Duct (25 ft.)	1	\$74.48	AC
889	3-1/4" x 10" Duct (5 Pieces)	5 *	\$30.50	AC
DT6W	6" Insulated Duct (25 ft.)	1	\$104.34	AC

Broan – NuTone Elbows

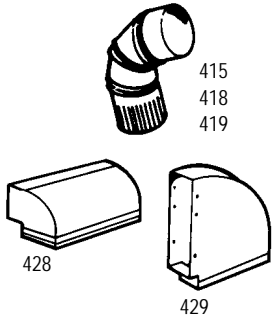

Model No.	Description	Std. Pk.	List Price	Code
415	7" Adjustable Elbow	4 *	\$18.44	AC
418	10" Adjustable Elbow	1	\$44.58	AC
419	6" Adjustable Elbow	1	\$19.48	AC
428	3-1/4" x 10" Vertical Elbow	1	\$36.70	AC
429	3-1/4" x 10" Horizontal Elbow	1	\$49.26	AC
430	Short Eave Elbow for 3-1/4" x 10" duct with backdraft damper and grille	1	\$64.04	AC
431	Long Eave Elbow for 3-1/4" x 10" duct with backdraft damper and grille	1	\$64.28	AC
432	8" Round Elbow	1	\$32.56	AC

Broan – NuTone Hanger Bars

Model No.	Description	Std. Pk.	List Price	Code
QTHB1	One set of hanger bars for QTR Series	1	\$19.44	AC

● Item too large to ship via UPS/FedEx. Item shipped common carrier at minimum rates.
 * All pricing reflects the individual item cost. You must order in multiples as indicated.
 ◆ UL listed for use over bathtubs and showers when connected to a GFCI protected branch circuit.

Accessories — Decorator Wall Mounted Controls

Broan® Decorator Wall Mounted Controls

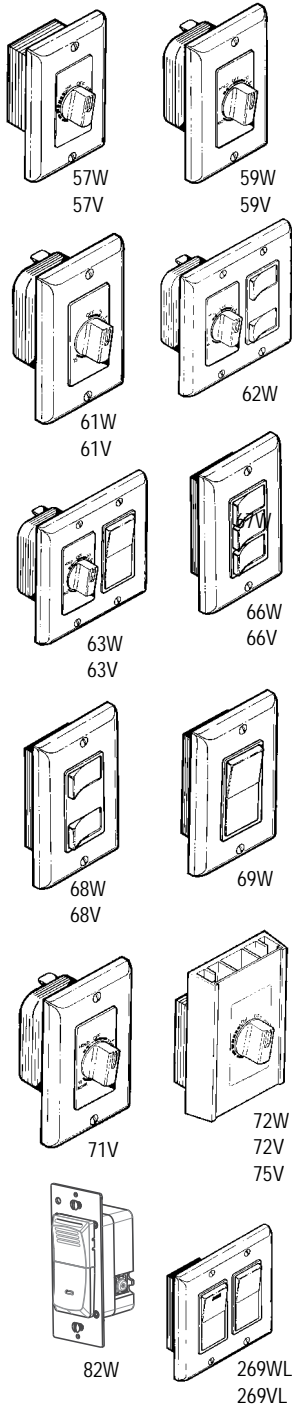

Model No.	Description	Std. Pk.	List Price	Code
57V / 57W	Electronic Variable Speed Control, 3 amp capacity. 120V. Fits single gang box.	1	\$48.50	AC
59V / 59W	60 Minute Time Control, with "continuous on" feature. Fits single gang box.	1	\$62.76	AC
61V / 61W	15 Minute Time Control, no "continuous on" feature. Fits single gang box.	1	\$62.76	AC
62W	60 Minute Time Control with two rocker switches. Fits two-gang box.	1	\$93.10	AC
63V / 63W	60 Minute Time Control with one rocker switch. Fits two-gang box.	1	\$83.14	AC
64V / 64W	Fan/Light Control with off delay. Requires hot and neutral wires in switch box. Fits single gang box.	1	\$120.48	AC
66V / 66W	Three-Function Control. Fits single gang opening.	1	\$39.74	AC
68V / 68W	Two-Function Control. Fits single gang box.	1	\$32.28	AC
69W	Single Gang Control. One smooth action on/off rocker switch. Fits single gang box.	1	\$13.36	AC
71V	12 hour timer automatically turns the ventilator off at a time selected within a 12 hour period. Ivory.	1	\$66.10	AC
72V / 72W	Electronic Variable Speed Control, 6 amp capacity. 120V. Fits single gang box. Suitable for use with 331H, 332H, 335, 336, HLB3, HLB6, HLB9 and HLB11.	1	\$88.32	AC
75V	Electronic Variable Speed Control. Same as 72W/V, except 240V.	1	\$89.98	AC
82W	Premium Humidity Control with Sensaire technology that senses rapid rise in humidity. Also includes duty cycle timer. Fits in single gang box. (White)	1	\$105.36	AC
90	Thermostat Kit. Used to install built-in thermostat in Model 114 kickspace heater. Snap action, bi-metallic, effective temperature range of 40 – 130° F.	1	\$60.16	AC
277V	Electronic Variable Speed Control, 277V, 6A — Ivory. For models with "C" suffix.	1	\$95.26	AC
77DV / 77DW	Three-Function Control for use with sensing Fan/Lights (top switch provides three settings for sensor On/Auto/Off), remaining switches control light, night light and QT Heater/Fan/Light/Night Light (top switch controls light and night light, remaining switches control fan and heater).	1	\$46.38	AC
269VL / 269WL	Two-Function, Two-Gang Control. Two separate smooth action on/off rocker switches — one with pilot light which glows when power is on.	1	\$49.18	AC
CFT12WH	12-Hour Timer (White)	1	\$72.18	AC
VS63WH	15 Min. Timer Switch (White)	1	\$70.72	AC
VS66WH	60 Min. Timer/1 On/Off Switch (White)	1	\$90.36	AC
VS68WH	15 Min. Timer/1 On/Off Switch (White)	1	\$90.36	AC
S990712044	Function Labels for two-, three- and four-function wall decorator controls. Easily applied peel-off labels cover HEAT/VENT/LIGHT/NIGHT LIGHT ON/OFF/AUTO functions.	1	\$1.90	PT

W = WHITE decorator style; V = IVORY decorator style.

- Item too large to ship via UPS/FedEx. Item shipped common carrier at minimum rates.
- * All pricing reflects the individual item cost. You must order in multiples as indicated.
- ◆ UL listed for use over bathtubs and showers when connected to a GFCI protected branch circuit.

Accessories — Decorator Wall Mounted Controls

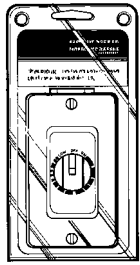

P57W

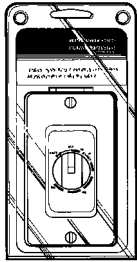

P59W
P59V

Broan® Decorator Wall Controls / “Blister Packs”

Packaged in see-through “blister packs” for pegboard mounting. Ideal for displays in showrooms to help stimulate sales.

Model No.	Description	Std. Pk.	List Price	Code
P57W	Electronic Variable Speed Control, 3 amp capacity. Fits single gang box.	4 *	\$50.66	AC
P59V / P59W	60 Minute Time Control with “continuous on” feature. Fits single gang box.	4 *	\$81.24	AC
P66V / P66W	Three-Function Control. Fits single gang opening.	4 *	\$42.32	AC
P68W	Two-Function Control. Fits single gang box.	4 *	\$34.82	AC

W = WHITE decorator style; V = IVORY decorator style.

Attic Ventilators — Powered

345SOBK
345SOWW

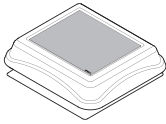

Broan® 28W Solar Powered Attic Ventilators

Remove heat from the attic in summer, help prevent moisture and ice dams in the winter without using any electricity! Energy saving solar powered attic ventilators also reduce energy costs by reducing running time of air conditioners. Easy retrofit can easily replace standard powered attic ventilators.

Model No.	Description	Std. Pk.	List Price	Code
345SOBK	Solar PAV, surface mount, black	1	\$584.78	SO
345SOWW	Solar PAV, surface mount, weathered wood	1	\$584.78	SO
CWT45	Thermostat for Solar PAVs	1	\$44.14	SO

Broan® Roof Mount Powered Attic Ventilators

High performance 14" wing blade. Thermally protected motor. Includes wiring box with a built-in adjustable thermostat. Easy to install.

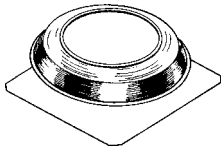

Model No.	Description	Std. Pk.	List Price	Code
349BR	1000 CFM, Brown Powder-Coated Steel Dome	1	\$267.84	HV
350BK	1050 CFM Attic Ventilator with black PVC dome	1	\$231.78	HV
350BR	1050 CFM Attic Ventilator with brown PVC dome	1	\$238.30	HV
355BK	1000 CFM Attic Ventilator with black PVC dome	1	\$245.60	HV
355BR	1000 CFM Attic Ventilator with brown PVC dome	1	\$252.14	HV
356BK	1600 CFM Attic Ventilator with black PVC dome	1	\$319.98	HV
356BR	1600 CFM Attic Ventilator with brown PVC dome	1	\$326.54	HV
358	1000 CFM Attic Ventilator with aluminum dome	1	\$284.42	HV

- Item too large to ship via UPS/FedEx. Item shipped common carrier at minimum rates.
- * All pricing reflects the individual item cost. You must order in multiples as indicated.
- ◆ UL listed for use over bathtubs and showers when connected to a GFCI protected branch circuit.

Attic Ventilators — Powered

Broan® Gable Mount Powered Attic Ventilator

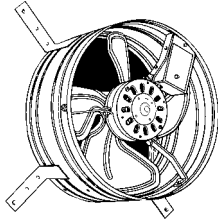

Outstanding performance from an inside-the-attic gable mounted unit. Designed to discharge hot attic air through existing 14" x 14" minimum or comparable louver in gable wall. High performance 14" wing blade. Thermally protected motor. Includes wiring box with a built-in adjustable thermostat. Easy to install.

Model No.	Description	Std. Pk.	List Price	Code
353	1020 CFM Gable Mount Ventilator (use with Broan Model 433 shutter — Sold separately, see below)	1	\$158.36	HV
35316	1600 CFM Gable Mount Ventilator (use with Broan Model 433 shutter — Sold separately, see below)	1	\$239.44	HV

Broan® Automatic Shutter for Gable Mount Attic Ventilators

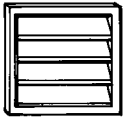

Precision built automatic wall shutter. Designed to be used with Broan Models 353 and 35316 Gable Mount Powered Attic Ventilators or Broan Models 345GOBK and 345GOWW Gable Mount Solar Powered Attic Ventilators. Aluminum vanes automatically open when ventilator turns on and are counter-balanced for easy opening; close when air flow ceases. Steel reinforced for strength, weather-tight closure. Easy to install.

Model No.	Description	Std. Pk.	List Price	Code
433	Automatic Shutter	1	\$85.50	AC

Broan® Powered Attic Ventilator Accessories

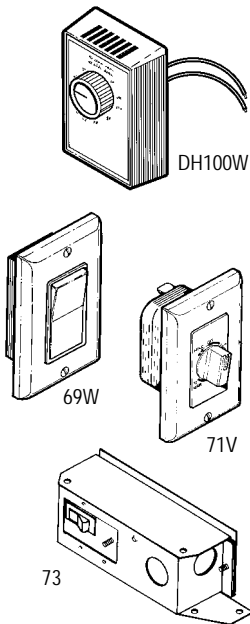

Model No.	Description	Std. Pk.	List Price	Code
DH100W	Dehumidistat, 24V/120V. (For use with all Broan powered attic ventilators — sold separately.)	1	\$49.44	AC
69W	Single Gang Control. One smooth action on/off rocker switch. Fits single gang box.	1	\$13.36	AC
71V	12 hour timer automatically turns the ventilator off at a time selected within a 12 hour period. Ivory.	1	\$66.10	AC
73	High temperature cut-off control automatically shuts off the PAV in the event of a high temperature condition (above 204° F.) Also includes a safety on/off switch to prevent fan from starting when cleaning or servicing.	1	\$46.64	AC

Broan® Powered Attic Ventilator Replacement Accessories

Model No.	Description	Std. Pk.	List Price	Code
RFTH95	Automatic, adjustable thermostat replacement part for NuTone powered attic ventilators.	1	\$23.20	AC

- Item too large to ship via UPS/FedEx. Item shipped common carrier at minimum rates.
- * All pricing reflects the individual item cost. You must order in multiples as indicated.
- ◆ UL listed for use over bathtubs and showers when connected to a GFCI protected branch circuit.

Central Vacuum Systems

NuTone® PurePower Series Power Units

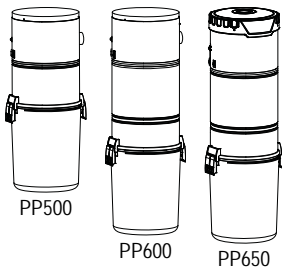

Model No.	Description	Std. Pk.	List Price	Code
PP500	NuTone PurePower 500 AW Power Unit	1	\$664.14	CX
PP600	NuTone PurePower 600 AW Power Unit	1	\$905.18	CX
PP650	NuTone PurePower 650 AW Power Unit	1	\$1,205.12	CX



VX1000
VX1000C

NuTone® Power Units — VX Series

Model No.	Description	Std. Pk.	List Price	Code
VX1000	Power Unit — Two, Two-Stage Universal Bypass Motors, Bag Filtration	1	\$1,553.24	CX
VX1000C	Power Unit — Two, Two-Stage Universal Bypass Motors, Cyclonic	1	\$1,553.24	CX

- Item too large to ship via UPS/FedEx. Item shipped common carrier at minimum rates.
- * All pricing reflects the individual item cost. You must order in multiples as indicated.
- ◆ UL listed for use over bathtubs and showers when connected to a GFCI protected branch circuit.

Central Vacuum Systems

NuTone® Tools, Hoses, Inlets, Tubing and Fittings

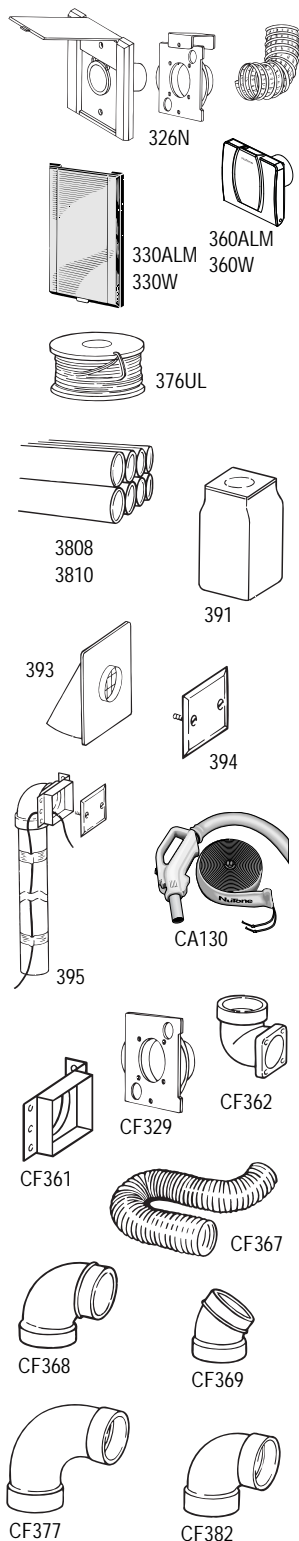

Model No.	Description	Std. Pk.	List Price	Code
326N	Existing Home Inlet Kit	1	\$71.24	CA
330ALM	Standard Inlet — Almond	1	\$9.12	CA
330W	Wall Inlet — White	1	\$9.12	CA
360ALM	Wall Inlet — Almond	1	\$21.42	CA
360W	Wall Inlet — White	1	\$21.42	CA
372	Standard Hose — 32' wire-reinforced vinyl	1	\$118.92	CA
376UL	Wire — 100' 18/2, UL approved	1	\$76.58	CA
3808	● 8' PVC Tubing	8 *	\$10.18	CA
3810	10' PVC Tubing	10 *	\$12.32	CA
391	Bags — pack of three (3)	1	\$12.32	CA
392	Muffler	1	\$30.00	CA
393	Metal Wall Cap	1	\$33.22	CA
394	Blank Cover Plate — White	1	\$20.88	CA
395	Inlet Rough-In Assembly Package — for new construction	1	\$88.92	CA
3964	Three-Inlet Installation Rough-In Package	1	\$116.24	CA
CA130	Hose Sock — fits 30' - 32' hoses (comes with assembly tube)	1	\$64.28	CA
CF329	Inlet Mounting Plate	1	\$6.42	CA
CF361	Mounting Bracket with Plastic Guard	1	\$15.00	CA
CF361F	Mount Plate w/Flanged Spigot — for any CF382 Series elbow	1	\$20.88	CA
CF362	Flanged Ell — 90°	1	\$3.22	CA
CF367	Flexible Tubing — 36" Length	6 *	\$14.46	CA
CF368	90° Street Ell	1	\$1.84	CA
CF369	45° Street Ell	1	\$1.84	CA
CF372	Utility Inlet — White	1	\$6.42	CA
CF377	90° Sweep Ell — Long	1	\$1.84	CA
CF380	Pipe Support with Wire Clip	1	\$1.08	CA
CF382	90° Sweep Ell	1	\$1.70	CA

● Item too large to ship via UPS/FedEx. Item shipped common carrier at minimum rates.
 * All pricing reflects the individual item cost. You must order in multiples as indicated.
 ◆ UL listed for use over bathtubs and showers when connected to a GFCI protected branch circuit.

NuTone® Tools, Hoses, Inlets, Tubing and Fittings CONTINUED

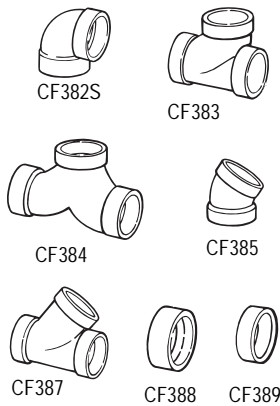

Model No.	Description	Std. Pk.	List Price	Code
CF382S	90° Short Ell	1	\$1.70	CA
CF383	90° Tee	1	\$2.36	CA
CF384	Three-Way Ell	1	\$3.74	CA
CF385	45° Ell	1	\$1.60	CA
CF387	45° Wye	1	\$3.22	CA
CF388	Stop Coupling	1	\$1.08	CA
CF389	End Cap	1	\$2.14	CA
CF3918	Filter Bags — Set of 3, 8 gallon capacity	1	\$20.36	CA
CH230L	High Performance Hose — 42' wire-reinforced vinyl with ON/OFF Switch	1	\$192.28	CA
CH235	Low Voltage Crushproof Hose — 30' features swivel handle	1	\$155.86	CA
CH515	Current-Carrying Crushproof Hose — 30'	1	\$367.96	CA
CH615	Current-Carrying Hose — 30', compatible with CI358, CI390 and CI395 Series Electrified Inlets	1	\$367.96	CA
CI3303RK	Rough-In Kit for three inlet installations. Use with 330 and CI335 Series Inlets.	1	\$125.34	CA
CI358W	Direct Connect Wall Valve (Electrified) — White	10 *	\$24.64	CA
CI376W	CanSweep Trim Plate — White	1	\$13.06	CA
CI377W	CanSweep Inlet — White	1	\$85.70	CA
CI399ALM	ElectraValve® Electrified Inlet — Almond	1	\$10.72	CA
CI399EB	E-Box Only for ElectraValve® Electrified Inlet	1	\$22.12	CA
CI399RK	Electrified Inlet Rough-In Kit	1	\$31.08	CA
CI399W	ElectraValve® Electrified Inlet — White	1	\$10.72	CA

● Item too large to ship via UPS/FedEx. Item shipped common carrier at minimum rates.

* All pricing reflects the individual item cost. You must order in multiples as indicated.

◆ UL listed for use over bathtubs and showers when connected to a GFCI protected branch circuit.

NuTone® Tools, Hoses, Inlets, Tubing and Fittings CONTINUED

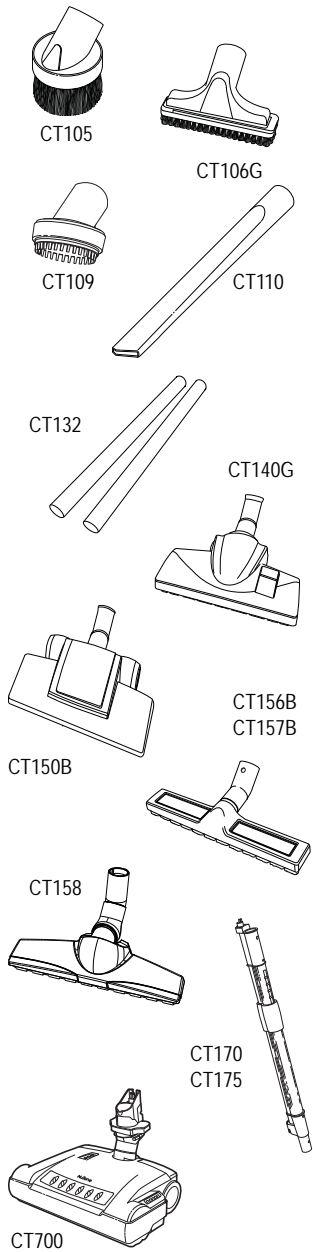

Model No.	Description	Std. Pk.	List Price	Code
CK135	Ratcheting Wand	1	\$28.94	CA
CS100	Car care attachment set	1	\$133.92	CA
CS200	Carpet & bare floor combination attachment set	1	\$143.54	CA
CS300	Bare floor attachment set	1	\$412.42	CA
CS400	Carpet & bare floor combination air turbine pet care attachment set	1	\$492.76	CA
CS500	Carpet & bare floor combination electric pigtail attachment set	1	\$889.10	CA
CS600	Carpet & bare floor combination electric direct connect attachment set	1	\$889.10	CA
CT105	Natural hair dusting brush	1	\$4.82	CA
CT106G	Upholstery Tool with Removable Brush. Natural Hair Bristles.	1	\$6.96	CA
CT109	Pet brush	1	\$3.74	CA
CT110	Long crevice tool	1	\$3.74	CA
CT132	Chrome Wands — set of two	1	\$27.32	CA
CT140G	Standard Combination Floor/Rug Tool	1	\$30.00	CA
CT143B	Universal Dusting Brush (elongated)	1	\$17.68	CA
CT150B	Deluxe Combination Floor/Rug Tool	1	\$25.16	CA
CT156B	Hardwood Floor Tool with Natural Hair Brush	1	\$27.32	CA
CT157B	Extra Wide Hardwood Floor Tool with Natural Hair Brush	1	\$38.56	CA
CT158	Premium twist and turn floor brush	1	\$45.00	CA
CT170	Adjustable wand for 20 Series hoses	1	\$56.24	CA
CT175	Adjustable wand for 15 Series hoses	1	\$56.24	CA
CT350B	Deluxe Air Turbine Brush	1	\$41.78	CA
CT700	Deluxe Power Brush	1	\$303.68	CA
VX3916	Standard Filter Media bags for VX475 Series (three bags per pack)	1	\$19.26	XH
VX3918	Premium Replacement bags for VX550 and VX1000 Series (three bags per pack)	1	\$77.40	XH
VX3918STD	Standard Filter Media bags for VX550 and VX1000 Series (three bags per pack)	1	\$19.74	XH

● Item too large to ship via UPS/FedEx. Item shipped common carrier at minimum rates.
 * All pricing reflects the individual item cost. You must order in multiples as indicated.
 ◆ UL listed for use over bathtubs and showers when connected to a GFCI protected branch circuit.

Door Chimes

NuTone® Hard-Wired Door Chimes

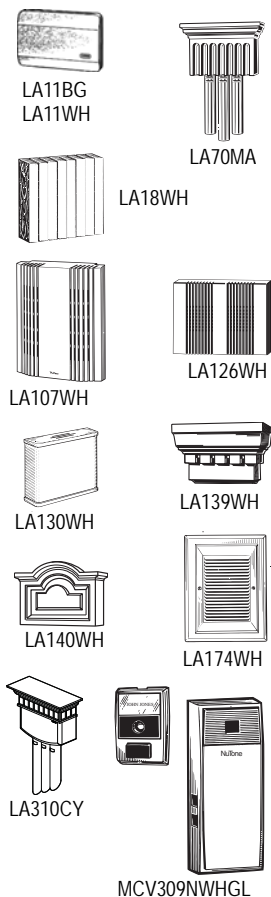

Model No.	Description	Std. Pk.	List Price	Code
LA11BG	Beige 2 Note	6 *	\$43.96	DC
LA11WH	White 2 Note	6 *	\$43.96	DC
LA14WH	White 2 Note Built-In	6 *	\$63.88	DC
LA18WH	White 2 Note	6 *	\$81.60	DC
LA39WH	White 2 Note Chord Tone	1	\$169.36	DC
LA70MA	Natural Maple Finish Wood Case — 4 – 8 Note	1	\$327.92	DC
LA100WH	Molded white finish, recessed grooves	3 *	\$38.06	DC
LA107WH	White 2 Note; Wired or Wireless	1	\$100.24	DC
LA126WH	White 2 Note	1	\$35.74	DC
LA130WH	White 2 Note	1	\$65.20	DC
LA139WH	Traditional White 2 Note	1	\$35.74	DC
LA140WH	Classic Arched Top 2 Note	1	\$35.74	DC
LA174WH	White 8 Note Electronic Built-In Chime (May be used with Intercom Systems)	1	\$138.94	DC
LA202WH	White with rounded corners	3 *	\$55.22	DC
LA305WL	Walnut finish real wood, brass insert, 3 brass finish tubes	1	\$365.68	DC
LA310CY	Cherry Cover with Satin Nickel Chambers (Eight-note, Four-note and Single-note Chimes)	1	\$419.34	DC
LA600WH	White MP3 Customizable Wired/Wireless Chime	1	\$102.82	DC
MCV309NWHGL	White & Gold 2 Note Mechanical Chime With Viewer	6 *	\$62.54	DC

NuTone® Wireless Door Chimes

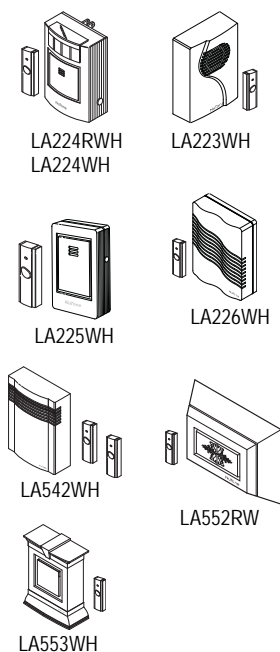

Model No.	Description	Std. Pk.	List Price	Code
LA223WH	White Wireless Plug-In Door Chime — 1, 2 or 8 notes	1	\$50.10	DC
LA224RWH	Visual Wireless Plug-In Door Chime Receiver — 1, 2 or 8 notes	1	\$81.86	DC
LA224WH	Visual Wireless Plug-In Door Chime — 1, 2 or 8 notes. Includes Receiver, Pushbutton and Pushbutton Battery.	1	\$91.70	DC
LA225WH	White Wireless Door Chime — 2 notes. Includes Receiver, Pushbutton and Pushbutton Battery.	1	\$44.24	DC
LA226WH	White Wireless Door Chime — 1, 2 or 8 notes. Includes Receiver.	1	\$67.78	DC
LA542WH	Front/back wireless with two buttons	3 *	\$69.12	DC
LA552RW	Americana wireless chime	1	\$85.68	DC
LA553WH	Pilot wireless chime	3 *	\$55.98	DC
LA600WH	White MP3 Customizable Wired/Wireless Chime	1	\$102.82	DC

- Item too large to ship via UPS/FedEx. Item shipped common carrier at minimum rates.
- * All pricing reflects the individual item cost. You must order in multiples as indicated.
- ◆ UL listed for use over bathtubs and showers when connected to a GFCI protected branch circuit.

Door Chimes

NuTone® Chime Kits (CHIME, TRANSFORMER, BUTTON(S))

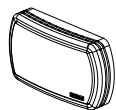

BK105
BK115LWH



BK147LWH

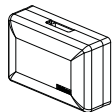

BK240LWH
BK240SLPB
BK240SLSN
BK242LWH

Model No.	Description	Std. Pk.	List Price	Code
BK105	Chime only, 2-note / 1-note	24 *	\$25.18	DC
BK110NBWH	Chime, 1 unlighted pushbutton, 1 std. transformer	24 *	\$33.42	DC
BK115LWH	Chime, 1 lighted pushbutton, 1 std. transformer	24 *	\$36.70	DC
BK120NBWH	Chime, 2 unlighted pushbutton, 1 std. transformer	24 *	\$35.44	DC
BK125LWH	Chime, 2 lighted pushbutton, 1 std. transformer	24 *	\$39.20	DC
BK131LPB	Chime, 1 lighted stucco pushbutton in polished brass, 1 std. transformer	24 *	\$39.34	DC
BK131LSN	Chime, 1 lighted stucco pushbutton in satin nickel, 1 std. transformer	6 *	\$39.34	DC
BK131LRBZ	Chime, 1 lighted stucco pushbutton in oil-rubbed bronze, 1 std. transformer	6 *	\$39.34	DC
BK144LCL	Chime, 1 lighted pushbutton round, 1 std. transformer	24 *	\$33.42	DC
BK147LWH	Recessed Chime, 1 lighted pushbutton, 1 std. transformer	24 *	\$56.48	DC
BK240LWH	Chime, 1 lighted pushbutton, 1 j-box transformer	24 *	\$40.38	DC
BK240SLPB	Chime, 1 lighted stucco pushbutton in polished brass, 1 j-box transformer	24 *	\$43.12	DC
BK240SLSN	Chime, 1 lighted stucco pushbutton in satin nickel, 1 j-box transformer	24 *	\$43.12	DC
BK242LWH	Chime, 2 lighted pushbutton, 1 j-box transformer	24 *	\$43.12	DC

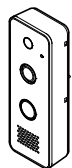

DCAM100



LA227WH

NuTone® Knock Smart Video Doorbell Camera

See and speak to visitors from anywhere in the world with NuTone Knock. Connects to existing doorbell wiring and the home's Wi-Fi network to stream live two-way audio and HD video to provide reliable, around-the-clock security.

Model No.	Description	Std. Pk.	List Price	Code
DCAM100	NuTone Knock™ Smart Video Doorbell Camera	1	\$416.00	DC
DCAM100FM	NuTone Knock™ Flush Mount Smart Video Doorbell Camera	1	\$457.60	DC
DCAM100RB	NuTone Knock™ Flush Mount Smart Video Doorbell Camera Rough-In Box	1	\$41.60	DC
LA227WH	NuTone Wi-Fi Door Chime	1	\$45.76	DC

- Item too large to ship via UPS/FedEx. Item shipped common carrier at minimum rates.
- * All pricing reflects the individual item cost. You must order in multiples as indicated.
- ◆ UL listed for use over bathtubs and showers when connected to a GFCI protected branch circuit.

NuTone® Wired Pushbuttons



PB7LBL
PB7LPB
PB7LSN
PB7LWH
PB7WH



PB18LWHCL
PB18WHCL



PB27LBR
PB27LSN



PB19LGL



PB41APB41LA



PB41BGL PB41LBR
PB41LBGL PB41LSN

Model No.	Description	Std. Pk.	List Price	Code
PB4LBL	Pushbutton, lighted in black	3 *	\$23.70	DA
PB4LBR	Pushbutton, lighted in oil-rubbed bronze	3 *	\$27.68	DA
PB4LSN	Pushbutton, lighted in satin nickel	3 *	\$27.68	DA
PB7LBL	Pushbutton, lighted in black	12 *	\$7.88	DA
PB7LPB	Pushbutton, lighted in polished brass	12 *	\$7.88	DA
PB7LSN	Pushbutton, lighted in satin nickel	12 *	\$7.88	DA
PB7LWH	Pushbutton, lighted in white	12 *	\$7.88	DA
PB7WH	Pushbutton, unlighted in white	12 *	\$7.88	DA
PB15LBR	Pushbutton, lighted in oil-rubbed bronze	3 *	\$27.68	DA
PB15LSN	Pushbutton, lighted in satin nickel	3 *	\$27.68	DA
PB18LWHCL	Pushbutton, clear with white cap — lighted	12 *	\$8.18	DA
PB18WHCL	Pushbutton, clear with white cap — unlighted	12 *	\$5.20	DA
PB19LGL	Pushbutton, polished brass — lighted	12 *	\$21.00	DA
PB27LBR	Pushbutton, lighted in oil-rubbed bronze	3 *	\$27.68	DA
PB27LSN	Pushbutton, satin nickel — lighted	6 *	\$27.68	DA
PB41APB41LA	Plastic Stucco Sleeves	24 *	\$3.60	DA
PB41BGL	Pushbutton, polished brass stucco — unlighted	24 *	\$7.52	DA
PB41LBGL	Pushbutton, polished brass stucco — lighted	24 *	\$10.48	DA
PB41LBR	Pushbutton, oil-rubbed bronze stucco — lighted	24 *	\$12.44	DA
PB41LSN	Pushbutton, satin nickel stucco — lighted	24 *	\$12.44	DA
PB53LWH	Pushbutton, lighted in white	3 *	\$23.70	DA
PB61LPB	Pushbutton, lighted in polished brass	3 *	\$25.96	DA
PB64LAB	Pushbutton, lighted in antique brass	3 *	\$22.06	DA
PB69LBL	Pushbutton, lighted in black	6 *	\$8.36	DA
PB69LSN	Pushbutton, lighted in satin nickel	6 *	\$10.56	DA

Note: The diamond symbol on the pushbuttons is currently being replaced with the NuTone Logo.

- Item too large to ship via UPS/FedEx. Item shipped common carrier at minimum rates.
- * All pricing reflects the individual item cost. You must order in multiples as indicated.
- ◆ UL listed for use over bathtubs and showers when connected to a GFCI protected branch circuit.

Door Chimes

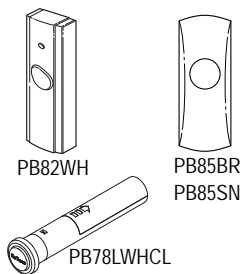

NuTone® Wireless Pushbuttons

Model No.	Description	Std. Pk.	List Price	Code
PB82WH	Unlighted, White	6 *	\$22.06	DC
PB85BR	Unlighted, Oil-Rubbed Bronze	6 *	\$38.30	DC
PB85SN	Unlighted, Satin Nickel	6 *	\$38.30	DC
PB78LWHCL	Wireless — White Lighted	1	\$28.68	DA

NuTone® Chime Accessories

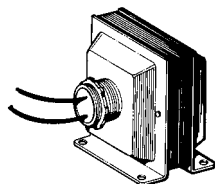

Model No.	Description	Std. Pk.	List Price	Code
C905	16v, 10va Transformer	6 *	\$17.78	DA
C907	16v, 30va Transformer	6 *	\$28.18	DA
C909	Tri-volt 8, 16, 24 Volt 20 VA Transformer	6 *	\$31.38	DA
C915	16v, 10va J-Box Transformer	6 *	\$28.18	DA
PBL2	Replacement bulbs for all lighted pushbuttons — Visu-Pack	12 *	\$6.02	DA
SPB18LWHCL	Replacement Bulb for round button	1	\$8.36	PT

Haven™

NuTone® Haven™ Backyard Lighting & Mosquito Repellent System features innovative landscape fixtures that provide season-long*, effective protection from biting mosquitoes. Don't let biting mosquitoes keep you from enjoying time outdoors with family and friends! Haven's patented mosquito protection system provides protection within 15 minutes of use and is effective against all types of mosquitoes. Four haven fixtures protect a typical deck or patio for over 440 square feet of coverage. They're easy to install and designed to mount on a deck post, railing or stake in the ground. Plus, you can add Haven to an existing low voltage lighting system or install with a transformer and cable for convenient protection from biting mosquitoes.

* 90 days of mosquito protection when used an average of 2.4 hours/day.

Model No.	Description	Std. Pk.	List Price	Code
HVRC1	Repellent Refill	1	\$69.68	ML
HVRC4	Repellent Refill (4 Pack)	1	\$214.24	ML

● Item too large to ship via UPS/FedEx. Item shipped common carrier at minimum rates.
 * All pricing reflects the individual item cost. You must order in multiples as indicated.
 ◆ UL listed for use over bathtubs and showers when connected to a GFCI protected branch circuit.

Heaters

NuTone® Surface Mount Ceiling Heater

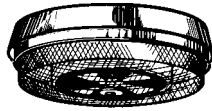

Enjoy the comfort of 1250 watts of instant heat in a bathroom, laundry room or any area where you want extra heat without using the central heating system. Easy to install ... fits standard 3-1/4" and 4" octagon, as well as 3-1/2" round electrical boxes. 11" diameter.

Model No.	Description	Std. Pk.	List Price	Code
157	Low-Profile Ceiling Heater — Same as Model 154 except with exclusive totally enclosed, sheathed element. 1250W, 120VAC.	1	\$139.26	HT

NuTone® High Capacity Wall Heaters

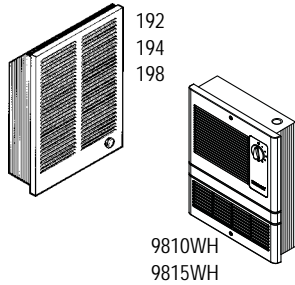

Large capacity fan-forced heaters for high heat loss areas such as lobbies, entranceways and vestibules. Easily convert to half-wattage. Totally enclosed, sheathed elements. Model 85 surface mount kit for Models 192, 194 and 198 available separately (see Page 18).

Model No.	Description	Std. Pk.	List Price	Code
192	Wall Heater, 1000/2000W+ 240VAC +, 750/1500W 208VAC. White painted grille.	1	\$439.70	HT
194	Wall Heater, 1500/3000W+ 240VAC +, 1125/2250W 208VAC. White painted grille.	1	\$463.40	HT
198	Wall Heater, 2000/4000W+ 240VAC +, 1500/3000W 208VAC. White painted grille.	1	\$485.48	HT
9810WH	1000W Fan-Forced Wall Heater, White polymeric grille, 120/240 volts.	1	\$277.12	HT
9815WH	1500W Fan-Forced Wall Heater, White polymeric grille, 120/240 volts.	1	\$284.68	HT

+ Factory wired wattage/voltage. Field convertible to other options listed.

NuTone® Kickspace Heaters

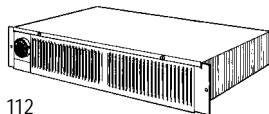

Slim and trim ... designed for permanent installation into any cabinet kickspace, vanity base or other area where wall space is limited. Perfect for stairway installation, ticket/toll booths, checkout counters, etc.

Model No.	Description	Std. Pk.	List Price	Code
112	Kickspace Heater. 1500W+ 240VAC +, 750/1500W 120VAC, with built-in thermostat. White.	1	\$291.82	HT
114	Kickspace Heater. Same as Model 112 except w/o built-in thermostat. White.	1	\$259.72	HT
90	Thermostat Kit — Used to install thermostat in Model 114 kickspace heater. Snap action, bi-metallic, effective temperature range of 40 – 130° F.	1	\$60.16	AC

+ Factory wired wattage/voltage. Field convertible to other options listed.

NuTone® Fan-Forced Wall Heaters

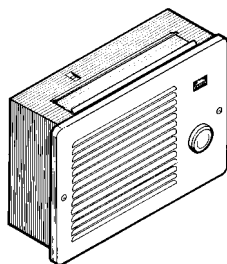

Perfect for the bathroom or other areas where fan-forced heat is needed quickly. Easily converts to half-wattage. Attractive white grille finish standard. Housing measures 10-1/4" W x 7-3/4" H x 3-3/4" D. Sturdy steel grille measures 12" W x 9-1/4" H x 1/2" D. Model 84 surface mount kit available separately (see Page 18).

Model No.	Description	Std. Pk.	List Price	Code
170	Wall Heater. 500/1000W+ 120VAC +, 750W 208VAC, 1000W 240 VAC. White painted grille.	1	\$179.20	HT
174	Wall Heater. 750/1500W+ 120VAC +, 1125W 208VAC, 1500W 240 VAC. White painted grille.	1	\$188.02	HT
178	Wall Heater. 1000/2000W+ 240VAC +, 750W/1500W 208 VAC. White painted grille.	1	\$201.56	HT

+ Factory wired wattage/voltage. Field convertible to other options listed.

- Item too large to ship via UPS/FedEx. Item shipped common carrier at minimum rates.
- * All pricing reflects the individual item cost. You must order in multiples as indicated.
- ◆ UL listed for use over bathtubs and showers when connected to a GFCI protected branch circuit.

NuTone® Heater Project Packs

Broan's project packs offer housings packed and sold separately from heater assemblies and grilles. You can buy housings for rough-in ... buy heater/motor assemblies and grilles later for finishing. Order Broan Model 83 Built-in Thermostat available separately — if required for "F" models (see below).

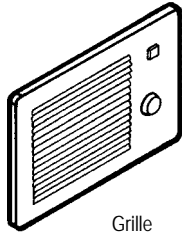

Grille

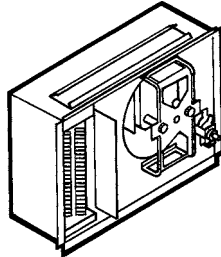

Project Pack Housing and Finish Unit

Model No.	Description	Std. Pk.	List Price	Code
171H	Project Pack Housing Unit. Use with all Finish Units.	4 *	\$35.94	HT
165FT	Project Pack Finish Unit. Use 171H Project pack housing for rough-in, includes built-in thermostat. 500W+ 120/240VAC +, 375 208VAC. White grille.	1	\$143.20	HT
167FT	Project Pack Finish Unit. Use 171H Project pack housing for rough-in, includes built-in thermostat. 750W+/1500/240VAC +, 562/1125W 208VAC. White grille.	1	\$143.20	HT
174F	Project Pack Finish Unit. Use 171H Project pack housing for rough-in. 750/1500W+ 120VAC +, 1125W 208VAC, 1500W 240VAC. White grille.	1	\$140.94	HT
174FT	Project Pack. Same as 174F except includes built-in thermostat.	1	\$152.04	HT

+ Factory wired wattage/voltage. Field convertible to other options listed.

NuTone® Register Heaters

Fan-forced heat for instant warmth from an attractive "register" type heater. Specially designed nickel-chrome element heats in seconds. Use convenient wall-mounted line-voltage thermostat (Broan Model 86W available separately — see below). Housing size 10-1/4" W x 7-3/4" H x 3-3/4" D. Sturdy steel grille size 14-1/4" W x 9-1/4" H x 7/8" D.

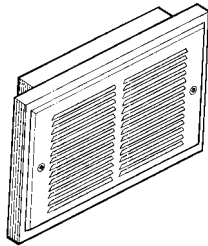

Model No.	Description	Std. Pk.	List Price	Code
120	Heater. 500/1000W+ 120VAC +, 750W 208VAC, 1000W 240VAC. White grille.	1	\$179.20	HT
124	Heater. 750/1500W+ 120VAC +, 1125W 208VAC, 1500W 240VAC. White grille.	1	\$188.02	HT
128	Heater. 1000/2000W+ 240VAC +, 750/1500W 208VAC. White grille.	1	\$193.72	HT

+ Factory wired wattage/voltage. Field convertible to other options listed.

NuTone® Heater Accessories

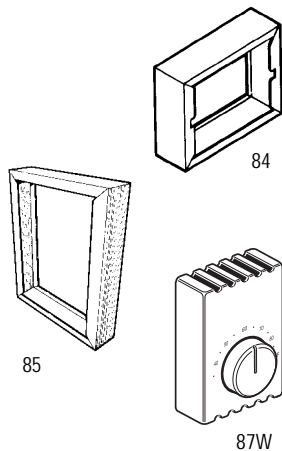

Model No.	Description	Std. Pk.	List Price	Code
83	Thermostat Kit. Used to install thermostat in Models 165F, 167F, 170F, 174F and 178F Wall Heaters. Snap action, bi-metallic. Rated 120/240VAC, 12.5 amps. Temperature range 40 – 125° F.	1	\$22.38	AC
84	Surface Mount Kit. White enameled steel. For use with Models 165F, 165FT, 167F, 167FT, 170, 170F, 170FT, 174, 174F, 174FT, 178, 178F and 178FT Wall Heaters.	1	\$45.76	AC
85	Surface Mount Kit. White enameled steel. For use with Models 192, 194 and 198 High Capacity Wall Heaters.	1	\$101.50	AC
87W	Line Voltage Wall Thermostat. Snap action bi-metallic, single pole — rated 120/240VAC, 22 amps. Temperature range 50 – 85° F. Decorator white finish.	1	\$32.38	AC
90	Thermostat Kit. Used to install built-in thermostat in Model 114 kickspace heater. Snap action, bi-metallic, effective temperature range of 40 – 130° F.	1	\$60.16	AC

● Item too large to ship via UPS/FedEx. Item shipped common carrier at minimum rates.

* All pricing reflects the individual item cost. You must order in multiples as indicated.

◆ UL listed for use over bathtubs and showers when connected to a GFCI protected branch circuit.

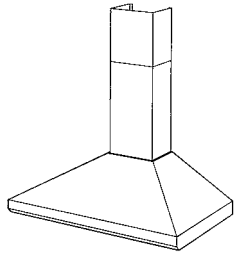

619004
6" Round Duct — Internal Blower
450 CFM, 9.0 Sones

614804
8" Round Duct — Internal Blower
900 CFM, 9.5 Sones

8" Round Duct — External Blower
280 – 1500 CFM

Broan® Elite 61000 Series

Wall-mounted hood with telescopic flue that accommodates 8' to 9' ceilings. Seamless corners provide stylish, easy cleaning surface. Three-speed blower with Heat Sentry™ and light control. Available in 30", 35-7/16" (90cm) and 48" widths in stainless. Two (30" & 35-7/16") or four (48") 20-watt halogen bulbs (included) provide bright cooktop lighting. Internal and external blower capability.

Model No.	Description	Std. Pk.	List Price	Code
30" 613004 ■	Stainless Steel Range Hood	1	\$2,294.68	DH
90cm 619004 ■	35-7/16" (90cm) Stainless Steel Range Hood	1	\$2,324.64	DH
619004EX ■	35-7/16" (90cm) Stainless Steel Range Hood, External Blower. Blowers are ordered separately. Select from Models 331H, 332H, 335, 336, HLB3, HLB6, HLB9 and HLB11 on Page 33.	1	\$1,698.02	DH
48" 614804 ●■	Stainless Steel Range Hood	1	\$2,594.36	DH
614804EX ●■	Stainless Steel Range Hood, External Blower. Blowers are ordered separately. Select from Models 331H, 332H, 335, 336, HLB3, HLB6, HLB9 and HLB11 on Page 33.	1	\$1,974.92	DH
RFX6104 ■	Ducted Flue Extension for 61000 Series with Internal Blower (not for Model 614804)	1	\$524.68	HA
RFX6104EX ■	Flue Extension for 61000EX Series with External Blower and Model 614804	1	\$582.98	HA
ROUNDFILTER ■	Replacement Non-ducted Charcoal Filter (for 613004 and 619004)	1	\$100.06	HA
ARP6 ■	CFM Reducer Kit. Reduces CFM to less than 300 CFM, 6" round when used with 613004 and 619004.	5 *	\$50.66	AC

Range hoods work with make-up dampers (MD6TU, MD8TU and MD10TU) and fresh air inlets (641FA, 643FA and 610FA) — see accessories on Page 4.

■ Limited quantities available.

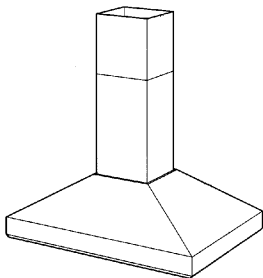

8" Round Duct — Internal Blower
900 CFM, 9.5 Sones

8" Round Duct — External Blower
280 – 1500 CFM

Broan® Elite 63000 Series

Island-mounted hood with telescopic flue accommodates 8' to 9' ceilings. Seamless corners provide stylish, easy cleaning surface. Three-speed blower with Heat Sentry™. 27-9/16" x 39-3/8" (70cm x 100cm) in stainless. Four 20-watt halogen bulbs (included) provide bright cooktop lighting.

Model No.	Description	Std. Pk.	List Price	Code
637004EX ●■	27-9/16" x 39-3/8" (70cm x 100cm) Stainless Steel Range Hood, External Blower. Blowers are ordered separately. Select from Models 331H, 332H, 335, 336, HLB3, HLB6, HLB9 and HLB11 on Page 33.	1	\$4,008.14	DH
RFX6304EX ■	Flue Extension for 9' to 10' ceilings	1	\$1,428.36	HA

Range hoods work with make-up dampers (MD6TU, MD8TU and MD10TU) and fresh air inlets (641FA, 643FA and 610FA) — see accessories on Page 4.

■ Limited quantities available.

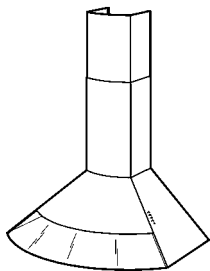

6" Round Duct — Internal Blower
450 CFM, 9.0 Sones

Broan® Elite RM65000 Series

This delightful, hand-crafted design blends curved and angular surfaces to form a stunning union of stainless steel and glass. The 65000 Series' 450 CFM centrifugal blower is combined with an advanced, multi-speed electronic control featuring a convenient 10-minute delay shut-off and Heat Sentry™. Two 20-watt halogen bulbs (included), two level brightness.

Model No.	Description	Std. Pk.	List Price	Code
RM659004 ●■	35-7/16" (90cm) Stainless Steel Range Hood	1	\$3,060.78	DH
ARP6 ■	CFM Reducer Kit. Reduces CFM to less than 300 CFM, 6" round.	5 *	\$50.66	AC

Range hoods work with make-up dampers (MD6TU, MD8TU and MD10TU) and fresh air inlets (641FA, 643FA and 610FA) — see accessories on Page 4.

■ Limited quantities available.

● Item too large to ship via UPS/FedEx. Item shipped common carrier at minimum rates.
* All pricing reflects the individual item cost. You must order in multiples as indicated.
◆ UL listed for use over bathtubs and showers when connected to a GFCI protected branch circuit.

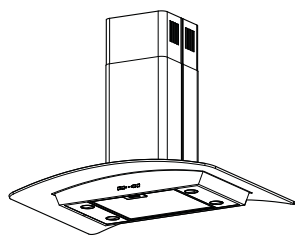

6" Round Duct — Internal Blower
High — 500 CFM, 10.5 Sones
Low — 200 CFM, 2.5 Sones

Compatible with Broan make-up air dampers.

Broan® Elite EI59 Series

Beautiful contemporary European glass island design. The curved glass canopy provides a stunning focal point without blocking the view of your surroundings. Electronic pushbutton control and halogen lighting (bulbs included).

Model No.	Description	Std. Pk.	List Price	Code
36" EI5936SS ●	Stainless Steel Range Hood	1	\$1,701.16	DH
FXNE59SS	Ducted or Non-ducted Flue Extension for 10' ceilings	1	\$703.24	AC
RKE59	Non-ducted Kit	1	\$230.18	AC
FILTERE56	Non-ducted Filter	1	\$59.28	AC
GU1035	Halogen Bulb; 120V, 35W	10 *	\$16.40	AC
MD6T Ø	6" Automatic Make-Up Air Damper	1	\$180.10	HA
MD8T Ø	8" Automatic Make-Up Air Damper	1	\$193.94	HA
MD10T Ø	10" Automatic Make-Up Air Damper	1	\$316.88	HA
BCR1	RF Remote Control	1	\$91.30	QA

Ø Work with fresh air inlets (641FA, 643FA and 610FA) — see accessories on Page 4.

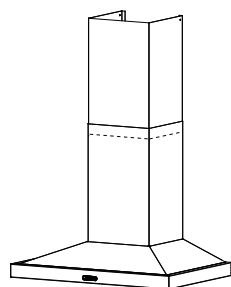

3-1/4" x 10" Duct — Internal Blower
(Vertical)
High — 550 CFM, 11.5 Sones
Low — 200 CFM, 1.4 Sones

6" Round Duct — Internal Blower
(Vertical)
High — 500 CFM, 12 Sones
Low — 180 CFM, 1.5 Sones

3-1/4" x 10" Duct — Internal Blower
(Horizontal)
High — 500 CFM, 10.5 Sones
Low — 180 CFM, 1.3 Sones

Broan® Elite EW54 Series

A sleek low-profile design enhanced by a dazzling new finish. Create a signature look and focal point in any kitchen with this stunning black stainless chimney hood. Tap-touch controls and halogen lighting (bulbs included).

Model No.	Description	Std. Pk.	List Price	Code
30" EW5430BLS ●	Black Stainless Steel Range Hood	1	\$1,305.02	DH
36" EW5436BLS ●	Black Stainless Steel Range Hood	1	\$1,382.26	DH
FXE54BLS	Ducted Flue Extension for 10' ceilings	1	\$459.38	AC
HRKMBS	Non-ducted Kit (Includes non-duct flue section)	1	\$278.10	AC
FILTERECM	Replacement Charcoal Filters	3 *	\$48.58	AC
GU10	Halogen Bulb; 120V, 50W max.	10 *	\$17.58	AC
MD6TU Ø	6" Universal Automatic Make-Up Air Damper	1	\$251.32	HA
MD8TU Ø	8" Universal Automatic Make-Up Air Damper	1	\$193.94	HA
MD10TU Ø	10" Universal Automatic Make-Up Air Damper	1	\$316.88	HA
ARP6	CFM Reducer Kit. Reduces CFM to less than 300 CFM	5 *	\$50.66	AC

Ø Work with fresh air inlets (641FA, 643FA and 610FA) — see accessories on Page 4.

● Item too large to ship via UPS/FedEx. Item shipped common carrier at minimum rates.
* All pricing reflects the individual item cost. You must order in multiples as indicated.
◆ UL listed for use over bathtubs and showers when connected to a GFCI protected branch circuit.

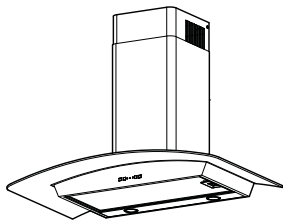

6" Round Duct — Internal Blower
High — 500 CFM, 10.5 Sones
Low — 200 CFM, 2.5 Sones

Compatible with Broan make-up air dampers.

Broan® Elite EW56 Series

Elegant European curved glass design that is both beautiful and functional. The airy design is a stunning focal point that complements its surrounding perfectly. Electronic pushbutton control and halogen lighting (bulbs included).

Model No.	Description	Std. Pk.	List Price	Code
30" EW5630SS ●	Stainless Steel Range Hood	1	\$1,129.78	DH
36" EW5636SS ●	Stainless Steel Range Hood	1	\$1,182.40	DH
FXNE56SS	Ducted or Non-ducted Flue Extension for 10' ceilings	1	\$409.68	AC
RKE56	Non-ducted Kit	1	\$230.18	AC
FILTERE56FL	Non-ducted Filter — Flat	1	\$75.42	AC
GU1035	Halogen Bulb; 120V, 35W	10 *	\$16.40	AC
MD6T Ø	6" Automatic Make-Up Air Damper	1	\$180.10	HA
MD8T Ø	8" Automatic Make-Up Air Damper	1	\$193.94	HA
MD10T Ø	10" Automatic Make-Up Air Damper	1	\$316.88	HA
BCR1	RF Remote Control	1	\$91.30	QA

Ø Work with fresh air inlets (641FA, 643FA and 610FA) — see accessories on Page 4.

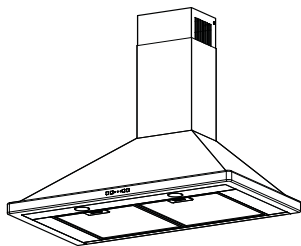

6" Round Duct — Internal Blower
High — 500 CFM, 10.5 Sones
Low — 200 CFM, 2.5 Sones

Compatible with Broan make-up air dampers.

Broan® Elite EW58 Series

Inspiring traditional European design. This wonderful design is executed to meet today's needs so that everyone can achieve their dream. Electronic pushbutton control and halogen lighting (bulbs included).

Model No.	Description	Std. Pk.	List Price	Code
30" EW5830SS ●	Stainless Steel Range Hood	1	\$1,129.78	DH
36" EW5836SS ●	Stainless Steel Range Hood	1	\$1,182.40	DH
FXNE58SS	Ducted or Non-ducted Flue Extension for 10' ceilings	1	\$293.40	AC
RKE58	Non-ducted Kit	1	\$230.18	AC
FILTERE56	Non-ducted Filter	1	\$59.28	AC
GU1035	Halogen Bulb; 120V, 35W	10 *	\$16.40	AC
MD6T Ø	6" Automatic Make-Up Air Damper	1	\$180.10	HA
MD8T Ø	8" Automatic Make-Up Air Damper	1	\$193.94	HA
MD10T Ø	10" Automatic Make-Up Air Damper	1	\$316.88	HA
BCR1	RF Remote Control	1	\$91.30	QA

Ø Work with fresh air inlets (641FA, 643FA and 610FA) — see accessories on Page 4.

● Item too large to ship via UPS/FedEx. Item shipped common carrier at minimum rates.
* All pricing reflects the individual item cost. You must order in multiples as indicated.
◆ UL listed for use over bathtubs and showers when connected to a GFCI protected branch circuit.

Range Hoods — Chimney

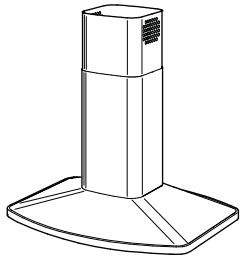

6" Round Duct — Internal Blower
High — 480 CFM, 9.5 Sones
Low — 230 CFM, 3.0 Sones

Broan® Elite E54000 Series

The E54000 Series island hood offers a clean and contemporary style with a soft touch. Engineered to meet today's conventional cooking appliances. 480 CFM multi-speed blower, large dishwasher-safe filters and four halogen lights (bulbs included) provide effective performance and brilliant task lighting.

Model No.	Description	Std. Pk.	List Price	Code
E5490SS ●	27-9/16" x 35-7/16" Stainless Steel Range Hood	1	\$2,871.10	DH
FX54SS	Ducted Flue Extension for 10' ceilings	1	\$957.04	HA
FXN54SS	Non-ducted Flue Extension for 10' ceilings	1	\$957.04	HA
RK54	Non-ducted Recirculation Kit	1	\$205.10	HA
FILTER SQUARE	Replacement Non-ducted Charcoal Filter	1	\$61.22	HA
ARP6	CFM Reducer Kit. Reduces CFM to less than 300 CFM, 6" round.	5 *	\$50.66	AC

Range hoods work with make-up dampers (MD6TU, MD8TU and MD10TU) and fresh air inlets (641FA, 643FA and 610FA) — see accessories on Page 4.

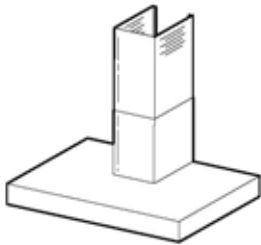

6" Round Duct — Internal Blower
370 CFM, 7.0 Sones

Broan® Elite RM53000 Series

This Italian inspired brushed stainless steel range hood proves that simplicity can be the perfect design statement and a match for today's conventional cooking appliances. A quiet 370 CFM multi-speed blower with Heat Sentry™, dishwasher-safe filters and generous lighting (bulbs included) provide effective performance and convenient operation.

Model No.	Description	Std. Pk.	List Price	Code
30" RM533004	Stainless Steel Chimney Hood	1	\$1,244.74	DH
36" RM533604 ●	Stainless Steel Chimney Hood	1	\$1,326.32	DH
42" RM534204 ●	Stainless Steel Chimney Hood	1	\$1,498.32	DH
RFX5304 ■	Ducted Flue Extension for 10' ceilings	1	\$300.24	HA
RFXN5304	Non-ducted Flue Extension for 10' ceilings	1	\$300.24	HA
RRK51	Non-ducted Recirculation Kit	1	\$151.58	HA
FILTER SQUARE	Replacement Non-ducted Charcoal Filter	1	\$61.22	HA
ARP6	CFM Reducer Kit. Reduces CFM to less than 300 CFM, 6" round.	5 *	\$50.66	AC

Range hoods work with make-up dampers (MD6TU, MD8TU and MD10TU) and fresh air inlets (641FA, 643FA and 610FA) — see accessories on Page 4.

■ Limited quantities available.

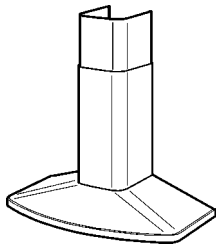

6" Round Duct — Internal Blower
370 CFM, 7.0 Sones

Broan® Elite RM52000 Series

This wall-mounted chimney hood combines graceful curves and traditional European styling. The 52000 Series is engineered to meet the requirements of today's highly styled, conventional appliances and kitchens. Its 370 CFM centrifugal blower and multi-speed control with Heat Sentry™ provide quiet, effective performance. Halogen lighting (bulbs included) accentuates the beauty of a fully enclosed bottom containing dishwasher-safe filters.

Model No.	Description	Std. Pk.	List Price	Code
30" RM523004	Stainless Steel Chimney Hood	1	\$1,244.74	DH
36" RM523604	Stainless Steel Chimney Hood	1	\$1,326.32	DH
42" RM524204 ●	Stainless Steel Chimney Hood	1	\$1,498.32	DH
RFX5204 ■	Ducted Flue Extension for 9' to 10' ceilings	1	\$291.54	HA
RFXN5204	Non-ducted Flue Extension for 9' to 10' ceilings	1	\$291.54	HA
RRK51	Non-ducted Recirculation Kit	1	\$151.58	HA
FILTER SQUARE	Replacement Non-ducted Charcoal Filter	1	\$61.22	HA
ARP6	CFM Reducer Kit. Reduces CFM to less than 300 CFM, 6" round.	5 *	\$50.66	AC

Range hoods work with make-up dampers (MD6TU, MD8TU and MD10TU) and fresh air inlets (641FA, 643FA and 610FA) — see accessories on Page 4.

■ Limited quantities available.

● Item too large to ship via UPS/FedEx. Item shipped common carrier at minimum rates.
* All pricing reflects the individual item cost. You must order in multiples as indicated.
◆ UL listed for use over bathtubs and showers when connected to a GFCI protected branch circuit.

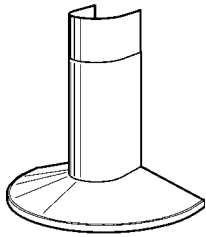

6" Round Duct — Internal Blower
370 CFM, 7.0 Sones

Broan® Elite RM51000 Series

The 51000 Series is a wall-mounted chimney hood with sleek, graceful curves that is engineered to meet the requirements of today's highly styled, conventional appliances and kitchens. Its 370 CFM centrifugal blower and multi-speed control with Heat Sentry™ provide quiet, effective performance. Halogen lighting (bulbs included) accentuates the beauty of a fully enclosed bottom containing dishwasher-safe filters.

Model No.	Description	Std. Pk.	List Price	Code
RM519004 ■	35-7/16" (90cm) Stainless Steel Chimney Hood	1	\$1,326.32	DH
RFX5104 ■	Ducted Flue Extension for 10' ceilings	1	\$291.54	HA
RRK51	Non-ducted Recirculation Kit	1	\$151.58	HA
FILTER SQUARE	Replacement Non-ducted Charcoal Filter (for RM51000, RM52000 and RM53000)	1	\$61.22	HA
ARP6	CFM Reducer Kit. Reduces CFM to less than 300 CFM, 6" round.	5 *	\$50.66	AC

Range hoods work with make-up dampers (MD6TU, MD8TU and MD10TU) and fresh air inlets (641FA, 643FA and 610FA) — see accessories on Page 4.

■ Limited quantities available.

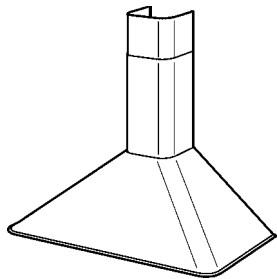

6" Round Duct — Internal Blower
290 CFM, 6.5 Sones

Broan® Elite RM50000 Series

The 50000 Series combines European design with tremendous value to meet the requirements of today's conventional appliance and kitchen styles. Its 290 CFM centrifugal blower and multi-speed control with Heat Sentry™ provide quiet, effective performance. A fully enclosed bottom contains a dishwasher-safe filter for easy cleaning. Plus, dual lighting provides excellent cooktop illumination.

Model No.	Description	Std. Pk.	List Price	Code
30" RM503001 ●	White Chimney Hood	1	\$1,005.70	DH
RM503004 ●	Stainless Steel Chimney Hood	1	\$1,005.70	DH
RM503023 ●■	Black Chimney Hood	1	\$1,005.70	DH
36" RM503601 ●	White Chimney Hood	1	\$1,098.96	DH
RM503604 ●	Stainless Steel Chimney Hood	1	\$1,098.96	DH
RM503623 ●■	Black Chimney Hood	1	\$1,098.96	DH
RFX5001	Ducted Flue Extension for 9' to 10' ceilings — White	1	\$291.54	HA
RFX5004 ■	Ducted Flue Extension for 9' to 10' ceilings — Stainless Steel	1	\$291.54	HA
RFXN5004	Non-ducted Flue Extension for 9' to 10' ceilings — Stainless Steel	1	\$291.54	HA
RFX5023	Ducted Flue Extension for 9' to 10' ceilings — Black	1	\$291.54	HA
FILTEREB40	Replacement Non-ducted Charcoal Filter (for RMP17004 and RM50000)	1	\$96.22	HA

■ Limited quantities available.

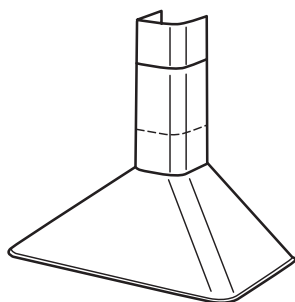

6" Round Duct — Internal Blower
High — 290 CFM, 5.5 Sones
Normal — 135 CFM, 0.5 Sones

Broan® Elite RME50000 Series (ENERGY STAR®)

The RME Series model is part of our new ENERGY STAR® hood offering and an extension of our popular RM50000 chimney hood line. Designed to provide energy efficient operation with a very quiet 290 CFM centrifugal blower. Features include 3-speed slide control, Heat Sentry™, dual 13 watt fluorescent lighting and a dishwasher-safe filter.

Model No.	Description	Std. Pk.	List Price	Code
RME5030SS ●	30" Stainless Steel Chimney Hood	1	\$1,084.16	RH
RFX5004 ■	Ducted Flue Extension for 9' to 10' ceilings — Stainless Steel	1	\$291.54	HA

■ Limited quantities available.

● Item too large to ship via UPS/FedEx. Item shipped common carrier at minimum rates.
* All pricing reflects the individual item cost. You must order in multiples as indicated.
◆ UL listed for use over bathtubs and showers when connected to a GFCI protected branch circuit.

Range Hoods — Chimney

Broan® B59 Series

The B59 Series ceiling-mounted island hood features a gently curving metal canopy that creates a dramatic, contemporary appearance and an open, airy feel. The 450 CFM centrifugal blower is operated by a 3-speed pushbutton control. This hood also features dishwasher-safe filters with quick-release latches and bright lighting provided by 4 halogen lamps.

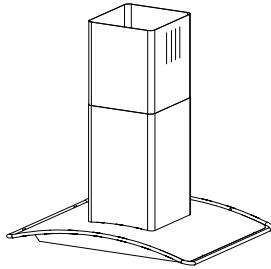

6" Round Duct - Internal Blower
450 CFM, 8.5 Sones

Model No.	Description	Std. Pk.	List Price	Code
36" B5936SS	Stainless Steel Range Hood	1	\$1,561.46	DH
FXN59SS	Ducted or Non-ducted Flue Extension for 10' ceilings	1	\$336.98	AC
RK59	Non-ducted Kit	1	\$170.14	AC
FILTER59	Non-ducted Filter	1	\$73.06	AC

Broan® B58 Series

The B58 Series wall-mounted chimney hood has a timeless design that has become the icon of European style. The 450 CFM centrifugal blower is operated by a 3-speed pushbutton control. This hood also features dishwasher-safe filters with quick-release latches and bright lighting from 2 halogen lamps.

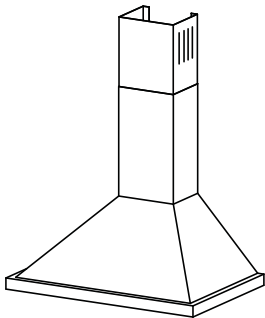

6" Round Duct - Internal Blower
450 CFM, 8.5 Sones

Model No.	Description	Std. Pk.	List Price	Code
30" B5830SS	Stainless Steel Chimney Hood	1	\$949.38	DH
36" B5836SS	Stainless Steel Chimney Hood	1	\$1,008.38	DH
FXN58SS	Ducted or Non-ducted Flue Extension for 10' ceilings	1	\$298.14	AC
RK58	Non-ducted Recirculation Kit	1	\$149.06	AC
ROUNDFILTER	Replacement Non-ducted Charcoal Filter	1	\$100.06	HA

Broan® B57 Series

The B57 Series wall-mounted chimney hood features a gently curving metal canopy that creates a dramatic, contemporary appearance and an open, airy feel. The 450 CFM centrifugal blower is operated by a 3-speed pushbutton control. This hood also features dishwasher-safe filters with quick-release latches and bright lighting from 2 halogen lamps.

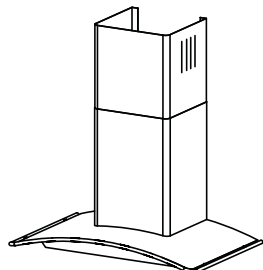

6" Round Duct - Internal Blower
450 CFM, 8.5 Sones

Model No.	Description	Std. Pk.	List Price	Code
30" B5730SS	Stainless Steel Chimney Hood	1	\$1,029.24	DH
36" B5736SS	Stainless Steel Chimney Hood	1	\$1,078.72	DH
FXN56SS	Ducted or Non-ducted Flue Extension for 10' ceilings	1	\$298.14	AC
RK56	Non-ducted Recirculation Kit	1	\$149.06	AC
ROUNDFILTER	Replacement Non-ducted Charcoal Filter	1	\$100.06	HA

- Item too large to ship via UPS/FedEx. Item shipped common carrier at minimum rates.
- * All pricing reflects the individual item cost. You must order in multiples as indicated.
- ◆ UL listed for use over bathtubs and showers when connected to a GFCI protected branch circuit.

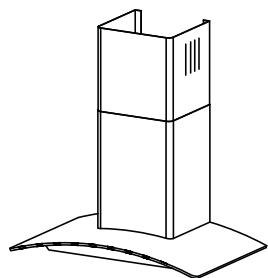

6" Round Duct - Internal Blower
450 CFM, 8.5 Sones

Broan® B56 Series

The B56 Series wall-mounted chimney hood features a gently curving glass canopy that creates a dramatic, contemporary appearance and an open, airy feel. The 450 CFM centrifugal blower is operated by a 3-speed pushbutton control. This hood also features dishwasher-safe filters with quick-release latches and bright lighting from 2 halogen lamps.

Model No.	Description	Std. Pk.	List Price	Code
30" B5630SS	Stainless Steel Chimney Hood	1	\$957.46	DH
36" B5636SS	Stainless Steel Chimney Hood	1	\$1,017.10	DH
FXN56SS	Ducted or Non-ducted Flue Extension for 10' ceilings	1	\$298.14	AC
RK56	Non-ducted Recirculation Kit	1	\$149.06	AC
ROUNDFILTER	Replacement Non-ducted Charcoal Filter	1	\$100.06	HA

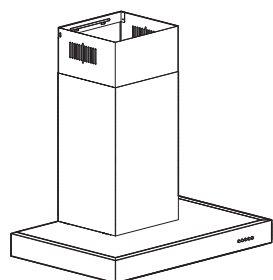

6" Round Duct - Internal Blower
450 CFM, 8.5 Sones

Broan® B53 Series

The B53 Series features clean lines and contemporary style that make these wall-mounted stainless steel hoods a popular choice. The 450 CFM centrifugal blower is operated by a 3-speed pushbutton control. This hood also features dishwasher-safe filters with quick-release latches and bright lighting provided by 2 halogen lamps.

Model No.	Description	Std. Pk.	List Price	Code
30" B5330SS	Stainless Steel Chimney Hood	1	\$906.96	DH
36" B5336SS	Stainless Steel Chimney Hood	1	\$972.52	DH
FXN53SS	Ducted or Non-ducted Flue Extension for 10' ceilings	1	\$268.80	HA
RK56	Non-ducted Recirculation Kit	1	\$149.06	AC
ROUNDFILTER	Replacement Non-ducted Charcoal Filter	1	\$100.06	HA

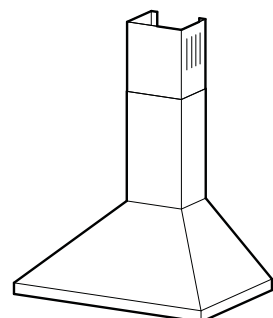

6" Round Duct - Internal Blower
350 CFM, 9 Sones

Broan® BW50 Series

The BW50 Series wall-mounted chimney hood has a timeless design that has become the icon of European style. The 350 CFM centrifugal blower is operated by a 3-speed pushbutton control. Bright halogen lighting illuminates the cooktop and dishwasher-safe filters feature quick-release latches.

Model No.	Description	Std. Pk.	List Price	Code
30" BW5030SS	Stainless Steel Chimney Hood	1	\$736.46	DH
36" BW5036SS	Stainless Steel Chimney Hood	1	\$770.44	DH
FXN58SS	Ducted or Non-ducted Flue Extension for 10' ceilings	1	\$298.14	AC
RK58	Non-ducted Recirculation Kit	1	\$149.06	AC
ROUNDFILTER	Replacement Non-ducted Charcoal Filter	1	\$100.06	HA

● Item too large to ship via UPS/FedEx. Item shipped common carrier at minimum rates.
 * All pricing reflects the individual item cost. You must order in multiples as indicated.
 ◆ UL listed for use over bathtubs and showers when connected to a GFCI protected branch circuit.

Broan® Elite RMDD Series Downdraft System

Designed specifically to be compatible with most conventional and commercial style cooktops combining a sensational appearance with high performance features. Stainless steel construction on all exposed surfaces provides a durable finish and an unforgettable look.

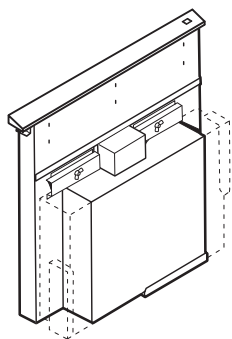

- 3-1/4" x 10" Duct — Internal Blower
500 CFM
- 3-1/4" x 14" Duct — Internal Blower
500 CFM
- 3-1/4" x 14" Duct — External Blower
280 – 1500 CFM

Model No.	Description	Std. Pk.	List Price	Code
30" RMDD3004	Downdraft with Internal Blower	1	\$1,766.54	DH
RMDD3004EX	Downdraft for External Blower. Fits 3-1/4" x 14" duct. Transition (Models 459 & 414) required to 10" rd. Blowers are ordered separately. Select from Models 331H, 332H, 335, 336, HLB3, HLB6, HLB9 and HLB11 on Page 33.	1	\$1,413.78	DH
36" RMDD3604	● Downdraft with Internal Blower	1	\$1,816.06	DH
RMDD3604EX	● Downdraft for External Blower. Fits 3-1/4" x 14" duct. Transition (Models 459 & 414) required to 10" rd. Blowers are ordered separately. Select from Models 331H, 332H, 335, 336, HLB3, HLB6, HLB9 and HLB11 on Page 33.	1	\$1,451.64	DH
48" RMDD4804	● Downdraft with Internal Blower	1	\$1,996.76	DH
RMDD4804EX	● Downdraft for External Blower. Fits 3-1/4" x 14" duct. Transition (Models 459 & 414) required to 10" rd. Blowers are ordered separately. Select from Models 331H, 332H, 335, 336, HLB3, HLB6, HLB9 and HLB11 on Page 33.	1	\$1,647.04	DH
RMDDRK	Remote Button Kit	1	\$72.86	HA
ARP310	CFM Reducer Kit. Reduces CFM to less than 300 CFM, 3-1/4" x 10".	5 *	\$50.66	AC

Downdrafts work with make-up dampers (MD6TU, MD8TU and MD10TU) and fresh air inlets (641FA, 643FA and 610FA) — see accessories on Page 4.

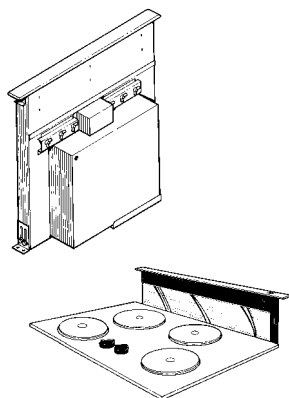

- 3-1/4" x 10" Duct — Internal Blower
500 CFM

Broan® 27000 Series Downdraft System ECLIPSE®

Ultimate styling complements virtually every cooktop style. Mounts behind most built-in cooktops in island, peninsula and wall mount installations. The unit mounts flush with the cooktop when not in operation, and is activated by light pressure on the cover which automatically raises the chimney 7" above the cooktop. The elevated chimney enables smoke and vapor to be captured at the top of most cooking vessels. A touch on the top of the chimney retracts it to its down position. Washable aluminum filters.

Model No.	Description	Std. Pk.	List Price	Code
30" 273003	Downdraft with stainless steel cover. 28" wide intake fits most nominal 30" wide cooktops.	1	\$1,079.00	DH
273001C	■ White Cover Only — Optional	1	\$86.12	HA
273002C	■ Bisque Cover Only — Optional	1	\$86.12	HA
273023C	Black Cover Only — Optional	1	\$86.12	HA
36" 273603	● Downdraft with stainless steel cover. 34" wide intake fits most nominal 36" wide cooktops.	1	\$1,079.00	DH
273601C	■ White Cover Only — Optional	1	\$86.12	HA
273602C	■ Bisque Cover Only — Optional	1	\$86.12	HA
273623C	Black Cover Only — Optional	1	\$86.12	HA
ARP310	CFM Reducer Kit. Reduces CFM to less than 300 CFM, 3-1/4" x 10".	5 *	\$50.66	AC

For replacement filters, see Broan's Replacement Parts Guide.

Downdrafts work with make-up dampers (MD6TU, MD8TU and MD10TU) and fresh air inlets (641FA, 643FA and 610FA) — see accessories on Page 4.

■ Limited quantities available.

● Item too large to ship via UPS/FedEx. Item shipped common carrier at minimum rates.
 * All pricing reflects the individual item cost. You must order in multiples as indicated.
 ◆ UL listed for use over bathtubs and showers when connected to a GFCI protected branch circuit.

Range Hoods — Downdrafts

Broan® 28000 Series Remote Downdraft System ECLIPSE®

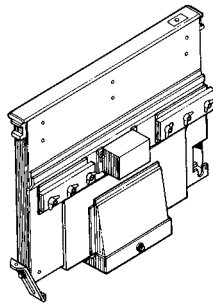

3-1/4" x 10" Duct — External Blower
280 – 1500 CFM

Model No.	Description	Std. Pk.	List Price	Code
30" 283003	Downdraft with stainless steel cover. Designed for use with exterior mounted blowers. 28" wide intake fits most nominal 30" wide cooktops. Transition required to 10" rd. Blower is ordered separately. Select from Models 332H, HLB3, HLB6, HLB9 and HLB11 on Page 33 (332KR not required).	1	\$749.46	DH
273001C	■ White Cover Only — Optional	1	\$86.12	HA
273002C	■ Bisque Cover Only — Optional	1	\$86.12	HA
273023C	Black Cover Only — Optional	1	\$86.12	HA
36" 283603	● Downdraft with stainless steel cover. Designed for use with exterior mounted blowers. 34" wide intake fits most nominal 36" wide cooktops. Transition required to 10" rd. Blower is ordered separately. Select from Models 332H, HLB3, HLB6, HLB9 and HLB11 on Page 33 (332KR not required).	1	\$749.46	DH
273601C	■ White Cover Only — Optional	1	\$86.12	HA
273602C	■ Bisque Cover Only — Optional	1	\$86.12	HA
273623C	Black Cover Only — Optional	1	\$86.12	HA

Downdrafts work with make-up dampers (MD6TU, MD8TU and MD10TU) and fresh air inlets (641FA, 643FA and 610FA) — see accessories on Page 4.

■ Limited quantities available.

Range Hoods — Power Packs

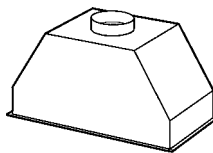

6" Round Duct — Internal Blower
400 CFM, 9.0 Sones
8" Round Duct — External Blower
280 – 1500 CFM

Broan® Elite RMP Series Custom Power Pack

The Rangemaster Custom Power Pack is designed to fit flush with the bottom of a cabinet or custom hood (see "RML" Liner — Page 28). The interior or exterior blowers are combined with multi-speed control with Heat Sentry™ to provide quiet and effective performance. Halogen lighting complements the beauty of a fully enclosed bottom containing dishwasher-safe filters. Optional non-ducted filters (FILTEREB40) for indoor exhaust recirculation. Some ductwork required.

Model No.	Description	Std. Pk.	List Price	Code
RMP17004	Power Pack	1	\$1,107.72	DH
RMPE7004	Power Pack for External Blower. Blowlers are ordered separately. Select from Models 331H, 332H, 335, 336, HLB3, HLB6, HLB9 and HLB11 on Page 33.	1	\$787.04	DH
FILTEREB40	Replacement Non-ducted Charcoal Filter (for RMP17004 and RM50000)	1	\$96.22	HA
GU10	Halogen Bulb: 120V, 50W max.	10 *	\$17.58	AC
ARP6	CFM Reducer Kit. Reduces CFM to less than 300 CFM, 6" round.	5 *	\$50.66	AC

Range hoods work with make-up dampers (MD6TU, MD8TU and MD10TU) and fresh air inlets (641FA, 643FA and 610FA) — see accessories on Page 4.

Broan® Elite RMIP Series Pro-Style Insert

Pro-style insert fits flush with the bottom of the cabinet or custom hood. Internal and external centrifugal blowers from 280 to 1500 CFM with Multi-speed control and Heat Sentry™ to provide quiet and effective performance. Halogen Lighting (bulbs not included) for brilliant illumination and easy-to-clean fully enclosed design. Options include baffle filters and remote wall control.

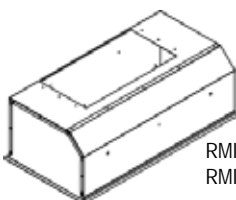

RMIP33
RMIP45
3-1/4" x 10" Duct — Internal Blower
460 CFM, 10.5 Sones
3-1/4" x 14" Duct — External Blower
850 CFM, 10.5 Sones
10" Round Duct — External Blower
280 – 1500 CFM



RMIPWC

Model No.	Description	Std. Pk.	List Price	Code
RMIP33	Pro-Style Insert (blower sold separately), 33" Stainless, Micro Filters; for use with P5, P8, 331H, 332H, 335, 336, HLB3, HLB6, HLB9 and HLB11 on Page 33	1	\$799.88	DH
RMIP45	● Pro-Style Insert (blower sold separately), 45", Stainless, Micro Filters; for use with P5, P8, 331H, 332H, 335, 336, HLB3, HLB6, HLB9 and HLB11 on Page 33	1	\$881.50	DH
RMIPWC	Wall-Mounted Remote Control for RMIP Series, Stainless	1	\$142.84	HA
RBFIP33	Baffle Filter Kit for RMIP33, Stainless	1	\$227.34	AC
RBFIP45	Baffle Filter Kit for RMIP45, Stainless	1	\$280.38	AC
PAR20	Halogen Bulb: 120V, 50W	6 *	\$23.90	AC
ARP310	CFM Reducer Kit. Reduces CFM to less than 300 CFM when used with P5 blower, 3-1/4" x 10".	5 *	\$50.66	AC

Range hoods work with make-up dampers (MD6TU, MD8TU and MD10TU) and fresh air inlets (641FA, 643FA and 610FA) — see accessories on Page 4.

- Item too large to ship via UPS/FedEx. Item shipped common carrier at minimum rates.
- * All pricing reflects the individual item cost. You must order in multiples as indicated.
- ◆ UL listed for use over bathtubs and showers when connected to a GFCI protected branch circuit.

Broan® Elite RML Series Liners for Inserts and Power Packs

Liners feature an adjustable nose that moves 3" to provide application flexibility and a 4" depth for excellent capture.

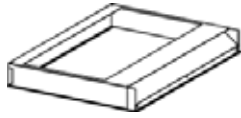

Model No.	Description	Std. Pk.	List Price	Code
RML3336S	Liner for RMP33 — 36", Stainless (Adj. depth 22.5" – 25.5")	1	\$323.22	HA
RML3342S	Liner for RMP33 — 42", Stainless (Adj. depth 22.5" – 25.5")	1	\$330.74	HA
RML4548S	Liner for RMP45 — 48", Stainless (Adj. depth 22.5" – 25.5")	1	\$349.48	HA
RML4554S	● Liner for RMP45 — 54", Stainless (Adj. depth 22.5" – 25.5")	1	\$382.00	HA
RML4560S	● Liner for RMP45 — 60", Stainless (Adj. depth 22.5" – 25.5")	1	\$387.24	HA
RML7030L	Liner for RMP1-E — 30", Stainless (Adj. depth 20.5" – 23.5")	1	\$292.74	HA
RML7030S	Liner for RMP1-E — 30", Stainless (Adj. depth 17.5" – 20.5")	1	\$273.90	HA
RML7036L	Liner for RMP1-E — 36", Stainless (Adj. depth 20.5" – 23.5")	1	\$330.74	HA
RML7036S	Liner for RMP1-E — 36", Stainless (Adj. depth 17.5" – 20.5")	1	\$323.22	HA
RML7048L	Liner for RMP1-E — 48", Stainless (Adj. depth 20.5" – 23.5")	1	\$405.24	HA
RML7048S	Liner for RMP1-E — 48", Stainless (Adj. depth 17.5" – 20.5")	1	\$349.48	HA

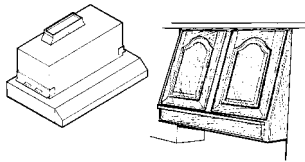

3-1/4" x 10" Duct — Internal Blower
360 CFM — 4.5 Sones Vertical
360 CFM — 4.5 Sones Horizontal

Broan® 10000 Series Custom Hood Kit

Model 103023 fits wood hoods from 30" to 42" wide. Comes standard for 30" installation. Order Extension Kit No. 97009790 for installations up to 36". 42" requires some fabrication. Requires 16-1/2" minimum vertical clearance inside hood. Must use Model 103123 Rough-In Kit below.

Model No.	Description	Std. Pk.	List Price	Code
103023	■ ● Wood Hood Insert	1	\$528.08	DH
103123	■ Wood Hood Insert Rough-In Kit (Required)	1	\$66.92	DH

For replacement filters, see Broan's Replacement Parts Guide.

Range hoods work with make-up dampers (MD6TU, MD8TU and MD10TU) and fresh air inlets (641FA, 643FA and 610FA) — see accessories on Page 4.

■ Limited quantities available.

Broan® PM500SS Power Pack

This power pack is designed to fit flush to custom cabinet/hood or can be used with optional liners to protect cabinetry.

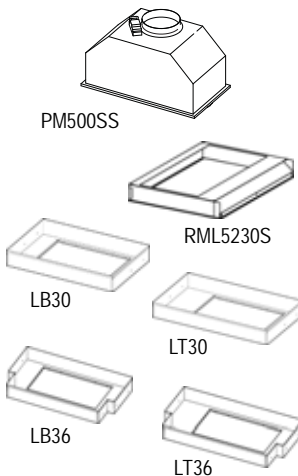

Model No.	Description	Std. Pk.	List Price	Code
PM500SS	Stainless Steel Power Pack, 20-1/2", 500 CFM	1	\$785.06	DH
<u>Liners</u>				
RML5230S	30" Stainless Adjustable Liner (Adjustable depth 17-1/2" to 20-1/2")	1	\$273.90	HA
RML5236L	36" Stainless Adjustable Liner (Adjustable depth 20-1/2" to 23-1/2")	1	\$330.74	HA
RML5236S	36" Stainless Adjustable Liner (Adjustable depth 17-1/2" to 20-1/2")	1	\$323.22	HA
LT30	30" Painted Liner	1	\$102.54	HA
LT36	36" Painted Liner	1	\$113.48	HA
LB30	30" Painted Liner	1	\$102.54	HA
LB36	36" Painted Liner	1	\$113.48	HA
<u>Non-ducted Recirculation</u>				
359NDK	Non-duct Accessory Kit for PM500 (99010374 - Replacement charcoal filter)	1	\$144.90	AC

Model PM500SS works with make-up air dampers (MD6TU, MD8TU and MD10TU) and fresh air inlets (641FA, 643FA and 610FA) — see accessories on Page 4.

- Item too large to ship via UPS/FedEx. Item shipped common carrier at minimum rates.
- * All pricing reflects the individual item cost. You must order in multiples as indicated.
- ◆ UL listed for use over bathtubs and showers when connected to a GFCI protected branch circuit.

Range Hoods — Power Packs

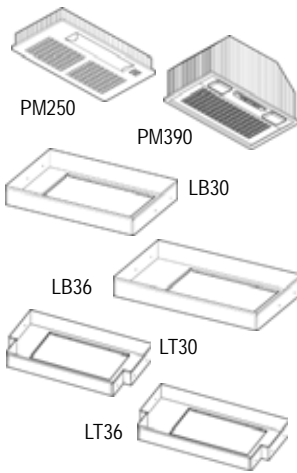

PM250 7" Round Duct — Internal Blower 250 CFM — 8.0 Sones
PM390 6" Round Duct — Internal Blower 390 CFM — 6.0 Sones

Broan® PM Series Flush-Fit Power Packs

Flush-fitting integrated power packs and liners provide modern style, ventilation, dual 40 watt lighting (bulbs sold separately) and protection for custom cabinet and hood applications. The PM390 has a 390 CFM internal blower and features a three-speed slide control with Heat Sentry™. The PM250 has a 250 CFM two-speed fan with rocker switch control. Both units are designed to work with optional LT or LB liners.

Model No.	Description	Std. Pk.	List Price	Code
PM250	Power Pack, Silver Grille	1	\$199.40	RH
PM390	Power Pack, Silver Grille	1	\$449.28	RH
356NDK +	Non-duct Accessory Kit for PM250	1	\$118.30	HA
357NDK +	Non-duct Accessory Kit for PM390	1	\$144.90	HA
LB30 +	Liner 30N, Box Shape, for PM250, PM390 and PME300	1	\$102.54	HA
LB36 +	Liner 36N, Box Shape, for PM250, PM390 and PME300	1	\$113.48	HA
LT30 +	Liner 30N, T Shape, for PM250, PM390 and PME300	1	\$102.54	HA
LT36 +	Liner 36N, T Shape, for PM250, PM390 and PME300	1	\$113.48	HA
ARP6 +	CFM Reducer Kit. Reduces CFM to less than 300 CFM, 6" round.	5 *	\$50.66	AC

+ Purchase separately.

Model PM390 works with make-up air dampers (MD6TU, MD8TU and MD10TU) and fresh air inlets (641FA, 643FA and 610FA) — see accessories on Page 4.

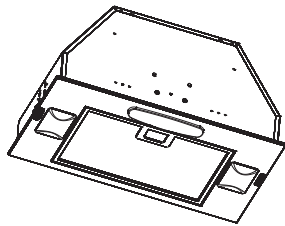

6" Round Duct — Internal Blower
 High — 290 CFM, 5.0 Sones
 Normal — 130 CFM, 0.5 Sones

Broan® PME300 Series Flush Fit Power Pack (ENERGY STAR®)

The PME Series model is part of our new ENERGY STAR® hood offering and an extension of our PM390 power pack line. Designed to provide energy efficient operation with a very quiet 290 CFM centrifugal blower. Features include 3-speed slide control, Heat Sentry™, dual 13 watt fluorescent light and a dishwasher-safe filter.

Model No.	Description	Std. Pk.	List Price	Code
PME300	Power Pack, Silver	1	\$625.04	RH
LB30 +	Liner 30N, Box Shape, for PM250, PM390 and PME300	1	\$102.54	HA
LB36 +	Liner 36N, Box Shape, for PM250, PM390 and PME300	1	\$113.48	HA
LT30 +	Liner 30N, T Shape, for PM250, PM390 and PME300	1	\$102.54	HA
LT36 +	Liner 36N, T Shape, for PM250, PM390 and PME300	1	\$113.48	HA

+ Purchase separately.

Broan® PM Series Stainless Steel Power Packs

These easy-to-clean stainless steel power packs feature bright LED lighting and dishwasher-safe, quick-release filters. Achieve a custom look and protect cabinetry with optional stainless steel liners.

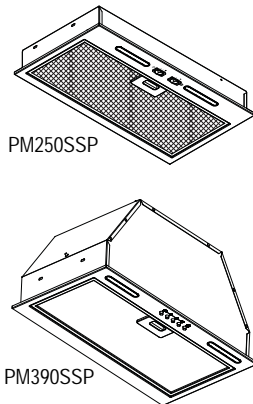

Model No.	Description	Std. Pk.	List Price	Code
PM250SSP	250 CFM LED Power Pack in Stainless Steel Finish	1	\$275.40	RH
PM390SSP	390 CFM LED Power Pack in Stainless Steel Finish	1	\$460.00	RH
LB30SS	30" Box Liner in Stainless Steel Finish	1	\$106.20	HA
LB36SS	36" Box Liner in Stainless Steel Finish	1	\$121.60	HA
358NDK	Non-Duct Kit for PM250SSP Power Pack	1	\$115.40	HA
360NDK	Non-Duct Kit for PM390SSP Power Pack	1	\$146.20	HA

● Item too large to ship via UPS/FedEx. Item shipped common carrier at minimum rates.
 * All pricing reflects the individual item cost. You must order in multiples as indicated.
 ◆ UL listed for use over bathtubs and showers when connected to a GFCI protected branch circuit.

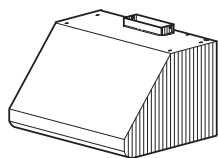

- 3-1/4" x 10" Duct — Internal Blower
600 CFM, 1.5 Sones
- 4-1/2" x 18" Duct — Internal Blower
1200 CFM, 2.0 Sones
- 10" Round Duct — External Blower
280 – 1500 CFM

Pro-Style Hoods — E60000 Series

The E60000 Series has a choice of two internal blowers or eight external blower options. Features include bright halogen lighting, dishwasher-safe baffle filters with a removable grease rail, variable speed control and Heat Sentry™. Options include a soffit flue, backsplash and non-duct recirculation. It is also compatible with Broan make-up air dampers. (Requires 50 watt max. halogen bulbs, not included; two in 30" and 36" — three in 42" and 48" widths.) Duct horizontal or vertical.

Model No.	Description	Std. Pk.	List Price	Code
<u>Internal Blower</u>				
30" E6030SS ●	Stainless Shell	1	\$1,964.86	DH
36" E6036SS ●	Stainless Shell	1	\$2,043.08	DH
42" E6042TSS ●	Stainless Shell	1	\$2,402.68	DH
48" E6048TSS ●	Stainless Shell	1	\$2,481.94	DH
<u>External Blower</u>				
30" E60E30SS ●	Stainless Shell	1	\$1,664.98	DH
36" E60E36SS ●	Stainless Shell	1	\$1,761.18	DH
42" E60E42SS ●	Stainless Shell	1	\$1,807.06	DH
48" E60E48SS ●	Stainless Shell	1	\$1,897.84	DH
AEE60302SS	12" High Soffit, 30" Hood	1	\$308.76	HA
AEE60362SS	12" High Soffit, 36" Hood	1	\$320.68	HA
AEE60422SS ●	12" High Soffit, 42" Hood	1	\$332.66	HA
AEE60482SS ●	12" High Soffit, 48" Hood	1	\$344.66	HA
ANKE60302SS	Non-Duct Recirculation Kit, 30" Hood	1	\$356.88	HA
ANKE60362SS	Non-Duct Recirculation Kit, 36" Hood	1	\$369.74	HA
ANKE60422SS	Non-Duct Recirculation Kit, 42" Hood	1	\$461.46	HA
ANKE60482SS	Non-Duct Recirculation Kit, 48" Hood	1	\$467.12	HA
ARP310	CFM Reducer Kit, reduces CFM to less than 300 CFM, 3-1/4" x 10"	5 *	\$50.66	AC
GU10	Halogen Bulb; 120V, 50W max.	10 *	\$17.58	AC
MD6T ∅	6" Automatic Make-Up Air Damper	1	\$180.10	HA
MD8T ∅	8" Automatic Make-Up Air Damper	1	\$193.94	HA
MD10T ∅	10" Automatic Make-Up Air Damper	1	\$316.88	HA

∅ Work with fresh air inlets (641FA, 643FA and 610FA) — see accessories on Page 4.

- Item too large to ship via UPS/FedEx. Item shipped common carrier at minimum rates.
- * All pricing reflects the individual item cost. You must order in multiples as indicated.
- ◆ UL listed for use over bathtubs and showers when connected to a GFCI protected branch circuit.

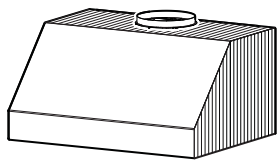

10" Round Duct — Internal Blower
1100 CFM — 12.0 Sones Vertical

Broan® Elite Pro Outdoor Hood — EPD61 Series

The Pro Outdoor is made of corrosion resistant stainless steel and provides an extra deep 27" design, giving it improved performance and best-in-class capture! It includes a powerful 1100 CFM internal blower for more exhaust capacity, yet quiet operation. An optional 3" wall extension provides a full 30" of cook top coverage for a larger capture area. Requires 50 watt halogen bulbs (not included); two in 36" and three in 48".

Model No.	Description	Std. Pk.	List Price	Code
36" EPD6136SS ●	Professional Grade Brushed Stainless Steel Range Hood	1	\$2,513.28	OH
42" EPD6142SS ●	Outdoor Stainless Steel Range Hood	1	\$2,677.20	OH
48" EPD6148SS ●	Professional Grade Brushed Stainless Steel Range Hood	1	\$2,841.10	OH
60" EPD6160SS ●	Professional Grade Brushed Stainless Steel Range Hood	1	\$3,748.18	OH
AWEPD36SS	3" Wall extension for 36" range hood (provides 30" depth)	1	\$398.86	OH
AWEPD42SS	3" Wall extension for 42" range hood	1	\$424.54	OH
AWEPD48SS	3" Wall extension for 48" range hood (provides 30" depth)	1	\$450.22	OH
AWEPD60SS	3" Wall extension for 60" range hood (provides 30" depth)	1	\$483.08	OH
AEEP6SS	6" Flue cover for 8' ceiling (for standard 27" depth hood)	1	\$189.48	OH
AEEP6SSE	6" Flue cover for 8' ceiling (for extended 30" depth hood)	1	\$205.42	OH
AEEP18SS	18" Flue cover for 9' ceiling (for standard 27" depth hood)	1	\$327.82	OH
AEEP18SSE	18" Flue cover for 9' ceiling (for extended 30" depth hood)	1	\$345.30	OH
AEEP30SS	30" Flue cover for 10' ceiling (for standard 27" depth hood)	1	\$432.72	OH
AEEP30SSE	30" Flue cover for 10' ceiling (for extended 30" depth hood)	1	\$450.22	OH
AEEP2445SS	Professional Grade Brushed Stainless Steel Flue Extension, standard 13" depth and height adjustable from 24" to 45"	1	\$868.72	OH
AEEP2445SSE	Professional Grade Brushed Stainless Steel Flue Extension, extended 16" depth and height adjustable from 24" to 45"	1	\$901.52	OH
GU10	Halogen Bulb; 120V, 50W max.	10 *	\$17.58	AC

● Item too large to ship via UPS/FedEx. Item shipped common carrier at minimum rates.

* All pricing reflects the individual item cost. You must order in multiples as indicated.

◆ UL listed for use over bathtubs and showers when connected to a GFCI protected branch circuit.

Range Hoods — High Performance

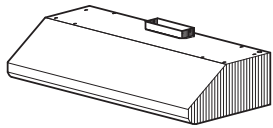

- 3-1/4" x 10" Duct — Internal Blower
600 CFM, 1.5 Sones
- 4-1/2" x 18" Duct — Internal Blower
1200 CFM, 2.0 Sones
- 10" Round Duct — External Blower
280 – 1200 CFM

Pro-Style Hoods — E64000 Series

The E64000 Series has a choice of two internal blowers or eight external blower options. Features include bright halogen lighting, dishwasher-safe baffle filters with a removable grease rail, variable speed control and Heat Sentry™. Options include a soffit flue, backsplash and non-duct recirculation. It is also compatible with Broan make-up air dampers. (Requires 50 watt max. halogen bulbs, not included; two in 30" and 36" — three in 42" and 48" widths.) Duct horizontal or vertical.

Model No.	Description	Std. Pk.	List Price	Code
<u>Internal Blower</u>				
30" E6430SS	Stainless Shell	1	\$1,306.48	DH
36" E6436SS	Stainless Shell	1	\$1,334.10	DH
42" E6442SS ●	Stainless Shell	1	\$1,434.88	DH
48" E6448SS ●	Stainless Shell	1	\$1,492.82	DH
E6448TSS ●	Stainless Shell	1	\$1,768.88	DH
<u>External Blower</u>				
30" E64E30SS	Stainless Shell	1	\$1,058.54	DH
36" E64E36SS	Stainless Shell	1	\$1,110.80	DH
42" E64E42SS ●	Stainless Shell	1	\$1,217.28	DH
48" E64E48SS ●	Stainless Shell	1	\$1,283.40	DH
ANKE60302SS	Non-Duct Recirculation Kit, 30" Hood	1	\$356.88	HA
ANKE60362SS	Non-Duct Recirculation Kit, 36" Hood	1	\$369.74	HA
ANKE60422SS	Non-Duct Recirculation Kit, 42" Hood	1	\$461.46	HA
ANKE60482SS	Non-Duct Recirculation Kit, 48" Hood	1	\$467.12	HA
ARP310	CFM Reducer Kit, reduces CFM to less than 300 CFM, 3-1/4" x 10"	5 *	\$50.66	AC
GU10	Halogen Bulb; 120V, 50W max.	10 *	\$17.58	AC
MD6T Ø	6" Automatic Make-Up Air Damper	1	\$180.10	HA
MD8T Ø	8" Automatic Make-Up Air Damper	1	\$193.94	HA
MD10T Ø	10" Automatic Make-Up Air Damper	1	\$316.88	HA

Ø Work with fresh air inlets (641FA, 643FA and 610FA) — see accessories on Page 4.

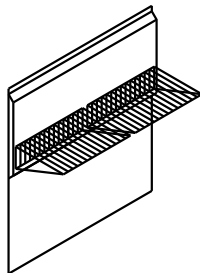

Broan® RMP Series Backsplash

Professional style backsplash with folding storage racks.

Model No.	Description	Std. Pk.	List Price	Code
30" RMP3004	Stainless Steel Backsplash	1	\$553.18	HA
36" RMP3604	Stainless Steel Backsplash	1	\$592.06	HA
42" RMP4204	Stainless Steel Backsplash	1	\$630.86	HA
48" RMP4804	Stainless Steel Backsplash	1	\$669.70	HA
54" RMP5404 ●	Stainless Steel Backsplash	1	\$708.64	HA
60" RMP6004 ●	Stainless Steel Backsplash	1	\$747.42	HA

- Item too large to ship via UPS/FedEx. Item shipped common carrier at minimum rates.
- * All pricing reflects the individual item cost. You must order in multiples as indicated.
- ◆ UL listed for use over bathtubs and showers when connected to a GFCI protected branch circuit.

Broan® Elite Internal and External Mounted Blowers

Broan internal and external blowers are specially designed to provide powerful, but quiet kitchen ventilation solutions to meet the unique needs of any application.

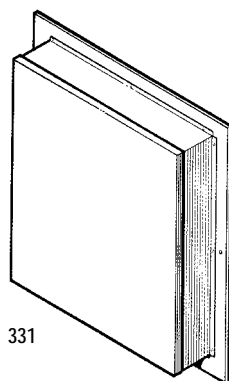

Model No.	Description	Std. Pk.	List Price	Code
P5	500 CFM Blower for interior mounting for RMIP insert. 3-1/4" x 10" duct size at discharge. 120V / 60 Hz.	1	\$520.06	RH
P8	850 CFM Blower for interior mounting for RMIP insert. 3-1/4" x 14" duct size at discharge. 120V / 60 Hz. Fits only in 36", 42" and 48" range hoods.	1	\$948.30	RH
331H +	600 CFM Exterior Blower — 2.3 amps. Fits 10" round duct.	1	\$662.32	DH
332H +	900 CFM Exterior Blower — 5.7 amps. Fits 10" round duct.	1	\$860.68	DH
335 +	1200 CFM Blower for exterior blower. 3.0 total amps. 10" round duct at discharge. 120V.	1	\$1,147.32	DH
336 +	1500 CFM Blower for exterior blower. 3.8 total amps. 10" round duct at discharge. 120V.	1	\$1,432.28	DH
HLB3 +	280 CFM In-Line Blower	1	\$437.52	DH
HLB6 +	600 CFM In-Line Blower	1	\$738.28	DH
HLB9 ●+	800 CFM In-Line Blower	1	\$989.88	DH
HLB11 ●+	1100 CFM In-Line Blower	1	\$1,181.28	DH
332KR	Rough-in Kit for Models 331H, 332H, 335 and 336 exterior blowers and HLB3, HLB6, HLB9 and HLB11 in-line blowers. Fits 10" round duct. Only for use with RMIP insert.	1	\$113.58	HA
72V / 72W	Electronic Variable Speed Control, 6 amp capacity. 120V. Fits single gang box. Suitable for use with 331H, 332H, 335, 336, HLB3, HLB6, HLB9 and HLB11.	1	\$88.32	AC

+ The 332KR will be required if external blower is used with RMIP models.

Note: Broan internal and external blowers are designed and UL listed for use with Broan products only. Use with other manufacturers' products can not be recommended and may result in violation of local electrical codes or practices.

● Item too large to ship via UPS/FedEx. Item shipped common carrier at minimum rates.
 * All pricing reflects the individual item cost. You must order in multiples as indicated.
 ◆ UL listed for use over bathtubs and showers when connected to a GFCI protected branch circuit.

Range Hoods — Under Cabinet

Broan® Elite Alta™ EQLD1 Series

The sculpted lines of Alta™ bring an exciting, new choice to typical range hood shapes. Sophisticated curves and perimeter aspiration enable new design possibilities while you experience the ultimate in capture efficiency. The sleek design is paired with a powerful 600 CFM blower that operates quietly at <0.8 sones at normal speed. Whisper-touch infrared controls make selection of three fan speeds and three light levels a breeze.

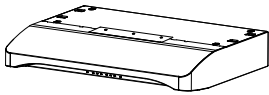

- 3-1/4" x 14" Duct — Internal Blower (Vertical) 450 CFM — High 0.8 Sones — Normal
- 7" Round Duct — Internal Blower (Vertical) 420 CFM — High 0.8 Sones — Normal
- 3-1/4" x 14" Duct — Internal Blower (Horizontal) 500 CFM — High 0.8 Sones — Normal

Model No.	Description	Std. Pk.	List Price	Code
30" EQLD130SS	Stainless Steel Range Hood	1	\$998.08	AX
36" EQLD136SS	Stainless Steel Range Hood	1	\$1,013.52	AX
HPF52	Non-Duct Charcoal Filters for 30" Series Hoods	2 *	\$49.44	AC
HPFA52	Replacement Open Mesh Filter for Perimeter Filtration Hood	2 *	\$52.54	AC
HAWRK3	ADA Electronic Adapter Kit	1	\$55.62	AC
HCR3	Handheld Remote	1	\$101.98	AC
MD6TU	6" Universal Make-Up Air Damper	1	\$251.32	HA
MD8TU	8" Universal Make-Up Air Damper	1	\$273.18	HA
MD10TU	10" Universal Make-Up Air Damper	1	\$360.60	HA
BP87Q	7" Damper for round discharge range hood	3 *	\$18.98	AC

Broan® Alta™ BQLA1 Series

The sculpted lines of Alta™ bring an exciting, new choice to typical range hood shapes. Sophisticated curves, infrared controls and hybrid baffle filters lend a pro-style edge to your kitchen. An impressive 400 CFM blower operates quietly at <0.5 sones at normal speed.

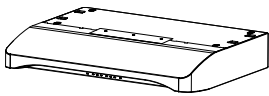

- 3-1/4" x 10" Duct — Internal Blower (Vertical) 360 CFM — High 0.3 Sones — Normal
- 7" Round Duct — Internal Blower (Vertical) 370 CFM — High 0.5 Sones — Normal
- 3-1/4" x 10" Duct — Internal Blower (Horizontal) 400 CFM — High 0.3 Sones — Normal

Model No.	Description	Std. Pk.	List Price	Code
30" BQLA130BL ■	Black Range Hood	1	\$736.46	AX
BQLA130SS	Stainless Steel Range Hood	1	\$782.80	AX
30" BQLA130WH ■	White Range Hood	1	\$736.46	AX
36" BQLA136BL ■	Black Range Hood	1	\$751.90	AX
BQLA136SS	Stainless Steel Range Hood	1	\$798.26	AX
36" BQLA136WH ■	White Range Hood	1	\$751.90	AX
HPF30	Non-Duct Charcoal Filter for 30" Series Hoods	3 *	\$44.80	AC
HPF36	Non-Duct Charcoal Filter for 36" Series Hoods	2 *	\$49.44	AC
HPFA430	Replacement Hybrid Baffle Filters for 30" Series Hoods	2 *	\$129.78	HA
HPFA436	Replacement Hybrid Baffle Filters for 36" Series Hoods	1	\$142.14	HA
HAWRK3	ADA Electronic Adapter Kit	1	\$55.62	AC
HCR3	Handheld Remote	1	\$101.98	AC
MD6TU	6" Automatic Make-Up Air Damper	1	\$251.32	HA
MD8TU	8" Automatic Make-Up Air Damper	1	\$273.18	HA
MD10TU	10" Automatic Make-Up Air Damper	1	\$360.60	HA
BP87Q	7" Damper for round discharge range hood	3 *	\$18.98	AC

■ Limited quantities available.

- Item too large to ship via UPS/FedEx. Item shipped common carrier at minimum rates.
- * All pricing reflects the individual item cost. You must order in multiples as indicated.
- ◆ UL listed for use over bathtubs and showers when connected to a GFCI protected branch circuit.

Broan® Alta™ BQDD1 Series

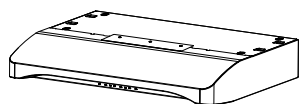

- 3-1/4" x 10" Duct — Internal Blower
(Vertical) 280 CFM — High
1.2 Sones — Normal
- 7" Round Duct — Internal Blower
(Vertical) 300 CFM — High
1.5 Sones — Normal
- 3-1/4" x 10" Duct — Internal Blower
(Horizontal) 250 CFM — High
1.2 Sones — Normal

The sculpted lines of Alta™ bring an exciting, new choice to typical range hood shapes. Wide curves and flush-mounted controls present a clean, striking design. Three fan speeds and a quiet 300 CFM blower make cooking more enjoyable. Tap-touch capacitive controls and deluxe micro-mesh filters with a decorative plate enhance the look of your hood and make cleaning a breeze.

Model No.	Description	Std. Pk.	List Price	Code	
30"	BQDD130BL	Black Range Hood	1	\$443.94	AX
	BQDD130BLS	Black Stainless Steel Range Hood	1	\$590.20	AX
	BQDD130SS	Stainless Steel Range Hood	1	\$490.28	AX
	BQDD130WW	White-on-White Range Hood	1	\$443.94	AX
36"	BQDD136BL	Black Range Hood	1	\$459.38	AX
	BQDD136BLS	Black Stainless Steel Range Hood	1	\$605.64	AX
	BQDD136SS	Stainless Steel Range Hood	1	\$505.74	AX
	BQDD136WW	White-on-White Range Hood	1	\$459.38	AX
HPF30	Non-Duct Charcoal Filter for 30" Series Hoods	3 *	\$44.80	AC	
HPF36	Non-Duct Charcoal Filter for 36" Series Hoods	2 *	\$49.44	AC	
HPFA3A30	Replacement Aluminum Open Mesh Filters for 30" Series Hoods	2 *	\$120.52	HA	
HPFA3A36	Replacement Aluminum Open Mesh Filters for 36" Series Hoods	2 *	\$139.06	HA	
HAWRK3	ADA Electronic Adapter Kit	1	\$55.62	AC	
BP87Q	7" Damper for round discharge range hood	3 *	\$18.98	AC	

Broan® Alta™ BQSJ Series

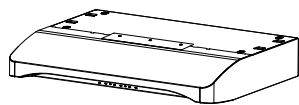

- 3-1/4" x 10" Duct — Internal Blower
(Vertical) 230 CFM — High
1.5 Sones — Normal
- 7" Round Duct — Internal Blower
(Vertical) 250 CFM — High
1.5 Sones — Normal
- 3-1/4" x 10" Duct — Internal Blower
(Horizontal) 210 CFM — High
1.5 Sones — Normal

The sculpted lines of Alta™ bring an exciting, new option to typical range hood shapes. Brilliant halogen lighting and hidden controls offer a beautiful alternative to traditional designs. The 250 CFM blower has two speed options and operates at 1.5 sones at normal speed. Dishwasher-safe micromesh filters provide efficient grease removal.

Model No.	Description	Std. Pk.	List Price	Code	
30"	BQSJ130BL	Black Range Hood	1	\$290.46	AX
	BQSJ130SS	Stainless Steel Range Hood	1	\$336.82	AX
	BQSJ130WW	White-on-White Range Hood	1	\$290.46	AX
36"	BQSJ136BL	Black Range Hood	1	\$305.92	AX
	BQSJ136SS	Stainless Steel Range Hood	1	\$352.26	AX
	BQSJ136WW	White-on-White Range Hood	1	\$305.92	AX
HPF30	Non-Duct Charcoal Filter for 30" Series Hoods	3 *	\$44.80	AC	
HPF36	Non-Duct Charcoal Filter for 36" Series Hoods	2 *	\$49.44	AC	
HPFAMM30	Replacement Aluminum Micro-Mesh Filters for 30" Series Hoods	3 *	\$52.54	AC	
HPFAMM36	Replacement Aluminum Micro-Mesh Filters for 36" Series Hoods	2 *	\$58.72	AC	
BP87Q	7" Damper for round discharge range hood	3 *	\$18.98	AC	

● Item too large to ship via UPS/FedEx. Item shipped common carrier at minimum rates.
 * All pricing reflects the individual item cost. You must order in multiples as indicated.
 ◆ UL listed for use over bathtubs and showers when connected to a GFCI protected branch circuit.

Range Hoods — Under Cabinet

Broan® Glacier™ BCDJ1 Series

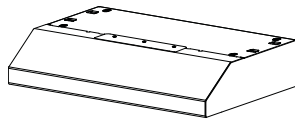

3-1/4" x 10" Duct — Internal Blower
360 CFM, 6.5 Sones, Vertical
400 CFM, 6.5 Sones, Horizontal
7" Round Duct — Internal Blower
370 CFM, 6.5 Sones, Vertical

Converts to non-ducted. Add non-ducted filter (available separately).

BCDJ1 series range hoods include impressive two-level LED light modules and a three-speed electronic pushbutton control with LCD display which shows hood status for fan and light setting, filter clean reminder, Heat Sentry™ and delay off. A powerful 400 CFM blower operates quietly at <1.0 sone at normal speed. Dishwasher-safe deluxe micro-mesh filters efficiently remove grease, while decorative patterned covers complement the hood design.

Model No.	Description	Std. Pk.	List Price	Code
30" BCDJ130BL	Black Range Hood	1	\$566.50	AH
BCDJ130SS	Stainless Steel Range Hood	1	\$613.88	AH
BCDJ130WH	White Range Hood	1	\$567.54	AH
36" BCDJ136BL	Black Range Hood	1	\$582.98	AH
BCDJ136SS	Stainless Steel Range Hood	1	\$628.30	AH
BCDJ136WH	White Range Hood	1	\$582.98	AH
42" BCDJ142BL ■	Black Range Hood	1	\$613.88	AH
BCDJ142SS	Stainless Steel Range Hood	1	\$659.20	AH
BCDJ142WH ■	White Range Hood	1	\$613.88	AH
HPF30	Non-Duct Charcoal Filters for 30" Series Hoods	3 *	\$44.80	AC
HPF36	Non-Duct Charcoal Filters for 36" Series Hoods	2 *	\$49.44	AC
HPF42	Non-Duct Charcoal Filters for 42" Series Hoods	2 *	\$56.66	AC
HPFA3B30	Replacement Deluxe Micro-Mesh Filters with Decorative Plate for 30" Series Hoods	2 *	\$105.06	HA
HPFA3B36	Replacement Deluxe Micro-Mesh Filters with Decorative Plate for 36" Series Hoods	2 *	\$120.52	HA
HPFA3B42	Replacement Deluxe Micro-Mesh Filters with Decorative Plate for 42" Series Hoods	1	\$139.06	HA
BP87Q	7" Damper for round discharge range hood	3 *	\$18.98	AC
HAWRK3	ADA Electronic Adapter Kit	1	\$55.62	AC

■ Limited quantities available.

Broan® Glacier BCDF1 Series

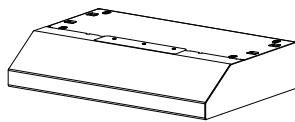

3-1/4" x 10" Duct — Internal Blower
280 CFM, 5.5 Sones, Vertical
250 CFM, 5.5 Sones, Horizontal
7" Round Duct — Internal Blower
300 CFM, 5.5 Sones, Vertical

Converts to non-ducted. Add non-ducted filter (available separately).

The clean, contemporary shape of Glacier complements any kitchen design. Features include impressive two-level LED light modules and three-speed capacitive touch controls for an easy-to-clean surface. The 300 CFM blower operates at 1.2 sones at normal speed.

Model No.	Description	Std. Pk.	List Price	Code
30" BCDF130SS	Stainless Steel Range Hood	1	\$459.38	AH
BCDF130BLS	Black Stainless Steel Range Hood	1	\$559.30	AH
36" BCDF136SS	Stainless Steel Range Hood	1	\$473.80	AH
BCDF136BLS	Black Stainless Steel Range Hood	1	\$574.74	AH
42" BCDF142SS	Stainless Steel Range Hood	1	\$490.28	AH
HPF30	Non-Duct Charcoal Filters for 30" Series Hoods	3 *	\$44.80	AC
HPF36	Non-Duct Charcoal Filters for 36" Series Hoods	2 *	\$49.44	AC
HPF42	Non-Duct Charcoal Filters for 42" Series Hoods	2 *	\$56.66	AC
HPFAMM30	Replacement Aluminum Micro-Mesh Filters for 30" Series Hoods	3 *	\$52.54	AC
HPFAMM36	Replacement Aluminum Micro-Mesh Filters for 36" Series Hoods	2 *	\$58.72	AC
HPFAMM42	Replacement Aluminum Micro-Mesh Filters for 42" Series Hoods	2 *	\$66.96	AC
BP87Q	7" Damper for round discharge range hood	3 *	\$18.98	AC
HAWRK3	ADA Electronic Adapter Kit	1	\$55.62	AC

● Item too large to ship via UPS/FedEx. Item shipped common carrier at minimum rates.

* All pricing reflects the individual item cost. You must order in multiples as indicated.

◆ UL listed for use over bathtubs and showers when connected to a GFCI protected branch circuit.

Range Hoods — Under Cabinet

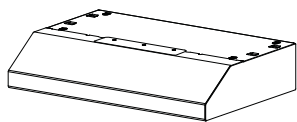

3-1/4" x 10" Duct — Internal Blower
230 CFM, 5.5 Sones, Vertical
210 CFM, 5.5 Sones, Horizontal
7" Round Duct — Internal Blower
250 CFM, 5.5 Sones, Vertical

Converts to non-ducted. Add
non-ducted filter
(available separately).

Broan® Glacier BCSEK1 Series

The BCSEK series range hoods feature two ENERGY STAR® LED light modules that illuminate evenly and are tested in cooking environments to ensure long life without dimming. Hidden two-speed rocker switch operates a 250 CFM blower. Dual dishwasher-safe, open-mesh filters provide efficient grease removal.

	Model No.	Description	Std. Pk.	List Price	Code
30"	BCSEK130BL	Black Range Hood	1	\$290.46	AH
	BCSEK130SL	Slate Range Hood	1	\$336.82	AH
	BCSEK130SS	Stainless Range Hood	1	\$336.82	AH
	BCSEK130WW	White-on-White Range Hood	1	\$290.46	AH
	HPF30	Non-Duct Charcoal Filters for 30" Series Hoods	3 *	\$44.80	AC
	HPFA130	Replacement Aluminum Open Mesh Filters for 30" Series Hoods	3 *	\$48.42	AC
	BP87Q	7" Damper for round discharge range hood	3 *	\$18.98	AC

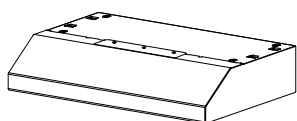

3-1/4" x 10" Duct — Internal Blower
230 CFM, 5.0 Sones, Vertical
210 CFM, 5.0 Sones, Horizontal
7" Round Duct — Internal Blower
250 CFM, 5.0 Sones, Vertical

Converts to non-ducted.
Add non-ducted filter
(available separately).

Broan® Glacier BCSD1 Series

The clean, contemporary shape of Glacier complements any kitchen design. Hidden two-speed rocker switches operate two-level halogen bulbs (50W bulbs not included) and a 250 CFM blower. Dual dishwasher-safe, open-mesh filters provide efficient grease removal.

	Model No.	Description	Std. Pk.	List Price	Code
24"	BCSD124BL	Black Range Hood	1	\$244.12	AH
	BCSD124SS	Stainless Steel Range Hood	1	\$290.46	AH
	BCSD124WW	White-on-White Range Hood	1	\$244.12	AH
30"	BCSD130BC	Bisque Range Hood	1	\$228.66	AH
	BCSD130BL	Black Range Hood	1	\$228.66	AH
	BCSD130SS	Stainless Steel Range Hood	1	\$275.02	AH
	BCSD130WW	White-on-White Range Hood	1	\$228.66	AH
36"	BCSD136BC	Bisque Range Hood	1	\$244.12	AH
	BCSD136BL	Black Range Hood	1	\$244.12	AH
	BCSD136SS	Stainless Steel Range Hood	1	\$290.46	AH
	BCSD136WW	White-on-White Range Hood	1	\$244.12	AH
42"	BCSD142BL	Black Range Hood	1	\$259.56	AH
	BCSD142SS	Stainless Steel Range Hood	1	\$305.92	AH
	BCSD142WW	White-on-White Range Hood	1	\$259.56	AH
	HPF24	Non-Duct Charcoal Filters for 24" Series Hoods	3 *	\$42.24	AC
	HPF30	Non-Duct Charcoal Filters for 30" Series Hoods	3 *	\$44.80	AC
	HPF36	Non-Duct Charcoal Filters for 36" Series Hoods	2 *	\$49.44	AC
	HPF42	Non-Duct Charcoal Filters for 42" Series Hoods	2 *	\$56.66	AC
	HPFA124	Replacement Aluminum Open-Mesh Filters for 24" Series Hoods	3 *	\$44.30	AC
	HPFA130	Replacement Aluminum Open-Mesh Filters for 30" Series Hoods	3 *	\$48.42	AC
	HPFA136	Replacement Aluminum Open-Mesh Filters for 36" Series Hoods	2 *	\$53.56	AC
	HPFA142	Replacement Aluminum Open-Mesh Filters for 42" Series Hoods	2 *	\$61.80	AC
	BP87Q	7" Damper for round discharge range hood	3 *	\$18.98	AC

● Item too large to ship via UPS/FedEx. Item shipped common carrier at minimum rates.

* All pricing reflects the individual item cost. You must order in multiples as indicated.

◆ UL listed for use over bathtubs and showers when connected to a GFCI protected branch circuit.

Broan® Sahale BKDB1 Series

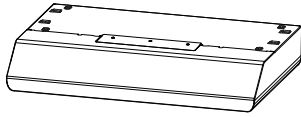

3-1/4" x 10" Duct — Internal Blower
 230 CFM, 5.0 Sones, Vertical
 210 CFM, 5.0 Sones, Horizontal
 7" Round Duct — Internal Blower
 250 CFM, 0 Sones, Vertical

Converts to non-ducted. Add non-ducted filter (available separately).

The slim and refined lines of Sahale bring a refreshing change to today's kitchens. Bright two-level LED lighting complements your cooking experience and three fan speeds make cooking more enjoyable. Tap-touch capacitive controls and dishwasher-safe micro-mesh filters make cleaning a breeze. 250 CFM blower operates at 1.5 sones at normal speed.

Model No.	Description	Std. Pk.	List Price	Code	
30"	BKDB130BL	Black Range Hood	1	\$383.16	AH
	BKDB130SS	Stainless Steel Range Hood	1	\$428.48	AH
	BKDB130WW	White-on-White Range Hood	1	\$383.16	AH
36"	BKDB136BL	Black Range Hood	1	\$398.62	AH
	BKDB136SS	Stainless Steel Range Hood	1	\$443.94	AH
	BKDB136WW	White-on-White Range Hood	1	\$398.62	AH
HPF30	Non-Duct Charcoal Filters for 30" Series Hoods	3 *	\$44.80	AC	
HPF36	Non-Duct Charcoal Filters for 36" Series Hoods	2 *	\$49.44	AC	
HPFAMM30	Replacement Aluminum Micro-Mesh Filters for 30" Series Hoods	3 *	\$52.54	AC	
HPFAMM36	Replacement Aluminum Micro-Mesh Filters for 36" Series Hoods	2 *	\$58.72	AC	
BP87Q	7" Damper for round discharge range hood	3 *	\$18.98	AC	
HAWRK3	ADA Electronic Adapter Kit	1	\$55.62	AC	

Broan® Sahale BKDEG1 Series

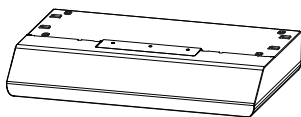

3-1/4" x 10" Duct — Internal Blower
 280 CFM, 5.5 Sones, Vertical
 250 CFM, 5.5 Sones, Horizontal
 7" Round Duct — Internal Blower
 300 CFM, 5.5 Sones, Vertical

Converts to non-ducted. Add non-ducted filter (available separately).

The BKDEG1 series features efficient two-level ENERGY STAR® LED lighting modules to enhance your cooking experience. Three fan speeds and a quiet 300 CFM blower make cooking more enjoyable. Tap-touch capacitive controls and deluxe micro-mesh filters with a decorative plate enhance the look of your hood and make cleaning a breeze.

Model No.	Description	Std. Pk.	List Price	Code	
30"	BKDEG130BL	Black Range Hood	1	\$443.94	AH
	BKDEG130SS	Stainless Range Hood	1	\$490.28	AH
	BKDEG130WW	White-on-White Range Hood	1	\$443.94	AH
30"	HPF30	Non-Duct Charcoal Filters for 30" Series Hoods	3 *	\$44.80	AC
	HPFA3A30	Replacement Deluxe Micro-Mesh Filters with Decorative Plate for 30" Series Hoods	2 *	\$120.52	HA
BP87Q	7" Damper for round discharge range hood	3 *	\$18.98	AC	

● Item too large to ship via UPS/FedEx. Item shipped common carrier at minimum rates.

* All pricing reflects the individual item cost. You must order in multiples as indicated.

◆ UL listed for use over bathtubs and showers when connected to a GFCI protected branch circuit.

Broan® Sahale — BKSH1 Series

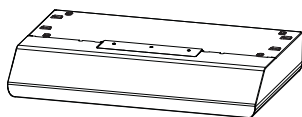

3-1/4" x 10" Duct — Internal Blower
 230 CFM, 5.0 Sones, Vertical
 210 CFM, 5.0 Sones, Horizontal
 7" Round Duct — Internal Blower
 250 CFM, 5.0 Sones, Vertical

Converts to non-ducted. Add
 non-ducted filter
 (available separately).

The slim and refined lines of Sahale bring a refreshing change to today's kitchens. Brilliant halogen lighting (bulbs included) flood the cooktop with generous illumination. A deluxe rocker switch controls two fan speeds, and the 250 CFM blower operates at 1.5 sones at normal speed. Dishwasher-safe micro-mesh filters provide efficient grease removal.

Model No.	Description	Std. Pk.	List Price	Code
30" BKSH130BL	Black Range Hood	1	\$275.02	AH
BKSH130SS	Stainless Steel Range Hood	1	\$321.36	AH
BKSH130WW	White-on-White Range Hood	1	\$275.02	AH
30"" HPF30	Non-Duct Charcoal Filters for 30" Series Hoods	3 *	\$44.80	AC
HPFAMM30	Replacement Aluminum Micro-Mesh Filters for 30" Series Hoods	3 *	\$52.54	AC
BP87Q	7" Damper for round discharge range hood	3 *	\$18.98	AC

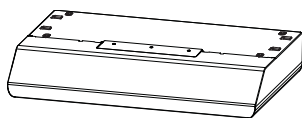

3-1/4" x 10" Duct — Internal Blower
 230 CFM, 5.0 Sones, Vertical
 210 CFM, 5.0 Sones, Horizontal
 7" Round Duct — Internal Blower
 250 CFM, 5.0 Sones, Vertical

Converts to non-ducted. Add
 non-ducted filter
 (available separately).

Broan® Sahale — BKSA1 Series

The slim and refined lines of Sahale bring a refreshing change to today's kitchens. Brilliant halogen lighting (bulbs included) flood the cooktop with generous illumination. A deluxe rocker switch controls two fan speeds, and the 250 CFM blower operates at 1.5 sones at normal speed. Dishwasher-safe micro-mesh filters provide efficient grease removal.

Model No.	Description	Std. Pk.	List Price	Code
30" BKSA130BL	Black Range Hood	1	\$213.22	AH
BKSA130SS	Stainless Range Hood	1	\$259.56	AH
BKSA130WW	White-on-White Range Hood	1	\$213.22	AH
30" HPF1	Non-Ducted Charcoal Filters for 30" Series Hoods	4 *	\$29.36	AC
HPFA	Replacement Aluminum Open Mesh Filter for 30" Series Hoods	3 *	\$34.00	AC
BP87Q	7" Damper for round discharge range hood	3 *	\$18.98	AC

● Item too large to ship via UPS/FedEx. Item shipped common carrier at minimum rates.
 * All pricing reflects the individual item cost. You must order in multiples as indicated.
 ◆ UL listed for use over bathtubs and showers when connected to a GFCI protected branch circuit.

Range Hoods — Under Cabinet

Broan® Elite™ Spire EPLEC1 Series

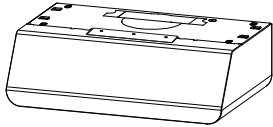

- 3-1/4" x 14" Duct — Internal Blower (Vertical) 540 CFM — High 0.8 Sones — Normal
- 7" Round Duct — Internal Blower (Vertical) 500 CFM — High 0.8 Sones — Normal
- 3-1/4" x 14" Duct — Internal Blower (Horizontal) 600 CFM — High 0.8 Sones — Normal

Broan Elite brings you Spire, an exciting new shape in a pro-style hood. Its ENERGY STAR® qualified lighting ensures energy savings while you enjoy pro-style performance. This hood incorporates modern features like bright LED lighting and hybrid baffle filters. Tap-touch controls operate 2-level lights and a powerful 600 CFM blower. Smooth-flow blower wheel design and high flow filters ensure quiet, 0.8 sone operation at normal speed.

Model No.	Description	Std. Pk.	List Price	Code
30" EPLEC130SS	Stainless Steel Range Hood	1	\$1,043.40	AH
36" EPLEC136SS	Stainless Steel Range Hood	1	\$1,058.84	AH
42" EPLEC142SS	Stainless Steel Range Hood	1	\$1,089.74	AH
48" EPLEC148SS	Stainless Steel Range Hood	1	\$1,120.64	AH
30" HPF24	Non-Duct Charcoal Filters (Type Xb) for 30" Series Hoods	3 *	\$42.24	AC
36" HPF30	Non-Duct Charcoal Filters (Type Xc) for 36" Series Hoods	3 *	\$44.80	AC
42" HPF36	Non-Duct Charcoal Filters (Type Xd) for 42" Series Hoods	2 *	\$49.44	AC
48" HPF42	Non-Duct Charcoal Filters (Type Xe) for 48" Series Hoods	2 *	\$56.66	AC
30" HPFA424	Replacement Hybrid Baffle Filters for 30" Series Hoods	2 *	\$122.58	HA
36" HPFA430	Replacement Hybrid Baffle Filters for 36" Series Hoods	2 *	\$129.78	HA
42" HPFA436	Replacement Hybrid Baffle Filters for 42" Series Hoods	1	\$142.14	HA
48" HPFA442	Replacement Hybrid Baffle Filters for 48" Series Hoods	1	\$163.78	HA
MD6TU	6" Universal Make-Up Air Damper	1	\$251.32	HA
MD8TU	8" Universal Make-Up Air Damper	1	\$273.18	HA
MD10TU	10" Universal Make-Up Air Damper	1	\$360.60	HA
HAWRK3	ADA Electronic Adapter Kit	1	\$55.62	AC

Broan® Spire BDP1 Series

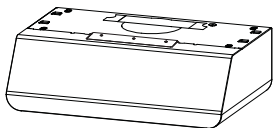

- 3-1/4" x 10" Duct — Internal Blower 360 CFM, 6.5 Sones — Vertical
 - 400 CFM, 6.5 Sones — Horizontal
 - 7" Round Duct — Internal Blower 370 CFM, 6.5 Sones — Vertical
- Converts to non-ducted. Add non-ducted filter (available separately).

An exciting new shape in a pro-style hood incorporates modern features like bright LED lighting and hybrid baffle filters. Deluxe rocker controls operate lights and a strong 400 CFM blower. Smooth-flow blower wheel design and high flow filters ensure quiet, <0.5 sone operation at normal speed.

Model No.	Description	Std. Pk.	List Price	Code
30" BDP130SS	Stainless Steel Range Hood	1	\$705.56	AH
36" BDP136SS	Stainless Steel Range Hood	1	\$721.00	AH
42" BDP142SS	Stainless Steel Range Hood	1	\$751.90	AH
48" BDP148SS	Stainless Steel Range Hood	1	\$782.80	AH
HPF24	Non-Duct Charcoal Filters (Type Xb) for 30" Series Hoods	3 *	\$42.24	AC
HPF30	Non-Duct Charcoal Filters (Type Xc) for 36" Series Hoods	3 *	\$44.80	AC
HPF36	Non-Duct Charcoal Filters (Type Xd) for 42" Series Hoods	2 *	\$49.44	AC
HPF42	Non-Duct Charcoal Filters (Type Xe) for 48" Series Hoods	2 *	\$56.66	AC
HPFA424	Replacement Hybrid Baffle Filters for 30" Series Hoods	2 *	\$122.58	HA
HPFA430	Replacement Hybrid Baffle Filters for 36" Series Hoods	2 *	\$129.78	HA
HPFA436	Replacement Hybrid Baffle Filters for 42" Series Hoods	1	\$142.14	HA
HPFA442	Replacement Hybrid Baffle Filters for 48" Series Hoods	1	\$163.78	HA
MD6TU	6" Universal Make-Up Air Damper	1	\$251.32	HA
MD8TU	8" Universal Make-Up Air Damper	1	\$273.18	HA
MD10TU	10" Universal Make-Up Air Damper	1	\$360.60	HA
641FA	Aluminum Fresh Air Inlet Wall Cap for 6" round duct	1	\$60.08	AC
643FA	Aluminum Fresh Air Inlet Wall Cap for 8" round duct	1	\$88.30	AC
610FA	Aluminum Fresh Air Inlet Wall Cap for 10" round duct	1	\$139.88	AC
BP87Q	7" Damper for round discharge range hood	3 *	\$18.98	AC

● Item too large to ship via UPS/FedEx. Item shipped common carrier at minimum rates.
 * All pricing reflects the individual item cost. You must order in multiples as indicated.
 ◆ UL listed for use over bathtubs and showers when connected to a GFCI protected branch circuit.

Range Hoods — Under Cabinet

Broan® Tenaya BDNF1 Series

Tenaya is a slim, transitional design with gentle radius features which makes it perfect for today's contemporary kitchens. Features include impressive two-level LED light modules and three-speed capacitive touch controls for an easy-to-clean surface. The 300 CFM blower operates quietly at 1.2 sones at normal speed.

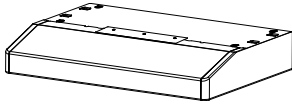

- 3-1/4" x 10" Duct — Internal Blower
(Vertical) 280 CFM — High
1.2 Sones — Normal
- 7" Round Duct — Internal Blower
(Vertical) 300 CFM — High
1.5 Sones — Normal
- 3-1/4" x 10" Duct — Internal Blower
(Horizontal) 250 CFM — High
1.2 Sones — Normal

Model No.	Description	Std. Pk.	List Price	Code	
30"	BDNF130BL	Black Range Hood	1	\$413.04	AX
	BDNF130SS	Stainless Steel Range Hood	1	\$459.38	AX
	BDNF130WW	White-on-White Range Hood	1	\$413.04	AX
36"	BDNF136BL ■	Black Range Hood	1	\$428.48	AX
	BDNF136SS	Stainless Steel Range Hood	1	\$474.84	AX
	BDNF136WW ■	White-on-White Range Hood	1	\$428.48	AX
42"	BDNF142SS	Stainless Steel Range Hood	1	\$505.74	AX
	HPF30	Non-Duct Charcoal Filters for 30" Series Hoods	3 *	\$44.80	AC
	HPF36	Non-Duct Charcoal Filters for 36" Series Hoods	2 *	\$49.44	AC
	HPF42	Non-Duct Charcoal Filters for 42" Series Hoods	2 *	\$56.66	AC
	HPFAMM30	Replacement Aluminum Micro-Mesh Filters for 30" Series Hoods	3 *	\$52.54	AC
	HPFAMM36	Replacement Aluminum Micro-Mesh Filters for 36" Series Hoods	2 *	\$58.72	AC
	HPFAMM42	Replacement Aluminum Micro-Mesh Filters for 42" Series Hoods	2 *	\$66.96	AC
	HAWRK3	ADA Electronic Adapter Kit	1	\$55.62	AC
	BP87Q	7" Damper for round discharge range hood	3 *	\$18.98	AC

■ Limited quantities available.

Broan® Tenaya BNSC1 Series

Slim lines and graceful radiuses combine to make Tenaya the perfect companion to today's contemporary kitchens. Hidden two-speed rocker switches operate two-level halogen bulbs (50W bulbs not included) and a 250 CFM blower and operates at 1.5 sones. A dishwasher-safe open-mesh filter provides efficient grease removal.

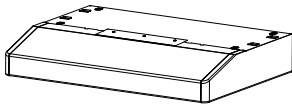

- 3-1/4" x 10" Duct — Internal Blower
(Vertical) 230 CFM — High
1.5 Sones — Normal
- 7" Round Duct — Internal Blower
(Vertical) 250 CFM — High
1.5 Sones — Normal
- 3-1/4" x 10" Duct — Internal Blower
(Horizontal) 210 CFM — High
1.5 Sones — Normal

Model No.	Description	Std. Pk.	List Price	Code	
30"	BNSC130BL	Black Range Hood	1	\$259.56	AX
	BNSC130SS	Stainless Steel Range Hood	1	\$305.90	AX
	BNSC130WW	White-on-White Range Hood	1	\$259.56	AX
36"	BNSC136BL ■	Black Range Hood	1	\$275.02	AX
	BNSC136SS ■	Stainless Steel Range Hood	1	\$321.36	AX
	BNSC136WW ■	White-on-White Range Hood	1	\$275.02	AX
	HPF1	Non-Duct Charcoal Filters for Open Bottom Hoods	4 *	\$29.36	AC
	HPFA	Replacement Open Mesh Filters for Open Bottom Hoods	3 *	\$34.00	AC
	BP87Q	7" Damper for round discharge range hood	3 *	\$18.98	AC

■ Limited quantities available.

● Item too large to ship via UPS/FedEx. Item shipped common carrier at minimum rates.
 * All pricing reflects the individual item cost. You must order in multiples as indicated.
 ◆ UL listed for use over bathtubs and showers when connected to a GFCI protected branch circuit.

Range Hoods — Under Cabinet

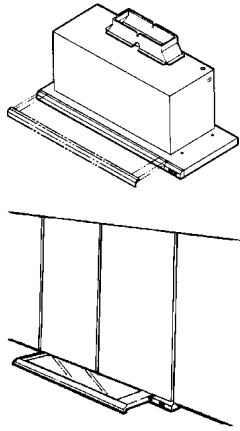

3-1/4" x 10" Duct — Internal Blower
300 CFM — 4.5 Sones Vertical

Broan® Elite 15000 Series Slide Out SILHOUETTE™

Thin-line styling to complement today's contemporary and European styled kitchens. Superior air movement provided by a high efficiency, dual centrifugal blower system. Solid-state infinite speed slide control with memory. Heat Sentry™. Bright, economical 24" fluorescent light (tube not included). Washable foam filter.

	Model No.	Description	Std. Pk.	List Price	Code
30"	153001	White Slide Out	1	\$1,010.08	DH
	153004	Brushed Aluminum Slide Out	1	\$1,049.62	DH
	153023	Black Slide Out	1	\$1,010.08	DH
36"	153601	White Slide Out	1	\$1,092.04	DH
	153604	Brushed Aluminum Slide Out	1	\$1,132.58	DH
	153623	Black Slide Out	1	\$1,092.04	DH

For replacement filters, see Broan's Replacement Parts Guide.

Broan® 46000 Series

Convertible to ducted or non-ducted (non-duct filter sold separately). Variable speed rotary control. 75-watt cooktop lighting (bulb sold separately).



3-1/4" x 10" Duct — Internal Blower
190 CFM — 7.5 Sones Vertical
190 CFM — 7.5 Sones Horizontal
7" Rounded Duct — Internal Blower
220 CFM — 7.5 Sones
Converts to non-ducted.

	Model No.	Description	Std. Pk.	List Price	Code
24"	462401	White Range Hood	1	\$206.12	RH
	462404	Stainless Steel Range Hood	1	\$266.68	RH
	462423	Black Range Hood	1	\$206.12	RH
30"	463001	White Range Hood	1	\$196.30	RH
	463002	Bisque Range Hood	1	\$196.30	RH
	463004	Stainless Steel Range Hood	1	\$256.84	RH
	463008	■ Almond Range Hood	1	\$196.30	RH
	463011	White-on-White Range Hood	1	\$196.30	RH
	463023	Black Range Hood	1	\$196.30	RH
	36"	463601	White Range Hood	1	\$206.12
463602		Bisque Range Hood	1	\$206.12	RH
463604		Stainless Steel Range Hood	1	\$266.68	RH
463623		Black Range Hood	1	\$206.12	RH
42"	464201	White Range Hood	1	\$216.02	RH
	464202	Bisque Range Hood	1	\$216.02	RH
	464204	Stainless Steel Range Hood	1	\$276.54	RH
	464208	■ Almond Range Hood	1	\$216.02	RH
	41F	Replacement Non-ducted Filter for F40000, 41000 and 46000 Series range hoods. Master Pack contains 6 filters. (S97007696 — Single Pack)	6 *	\$17.94	AC
	BP29	10-1/2" x 8-3/4" Washable Aluminum Filter for F40000, 40000, 42000 and 46000 Series. Contains 6 filters. (S97006931 — Single Pack)	6 *	\$9.62	AC

■ Limited quantities available.

Single packs are higher priced.

- Item too large to ship via UPS/FedEx. Item shipped common carrier at minimum rates.
- * All pricing reflects the individual item cost. You must order in multiples as indicated.
- ◆ UL listed for use over bathtubs and showers when connected to a GFCI protected branch circuit.

Broan® 43000 Series

Adapt to any installation with these four-way convertible range hoods. An enclosed light and fan/filter assembly makes for easy cleaning.



3-1/4" x 10" Duct — Internal Blower
 190 CFM — 7.0 Sones Vertical
 160 CFM — 7.0 Sones Horizontal
 7" Rounded Duct — Internal Blower
 220 CFM — 8.0 Sones Vertical

Converts to non-ducted. Includes washable aluminum filter with light lens.

Model No.	Description	Std. Pk.	List Price	Code
30" 433004	Stainless Steel Range Hood	1	\$211.30	LL
433011	White-on-White Range Hood	1	\$147.66	LL
433022	Bisque-on-Bisque Range Hood	1	\$147.66	LL
433023	Black Range Hood	1	\$147.66	LL
36" 433604	Stainless Steel Range Hood	1	\$218.56	LL
433611	White-on-White Range Hood	1	\$157.38	LL
433622 ■	Bisque-on-Bisque Range Hood	1	\$157.38	LL
433623	Black Range Hood	1	\$157.38	LL
BP57	11-3/8" x 11-3/4" Washable Aluminum and Charcoal Filter with light lens. Master pack contains 8 filters. (SR610050 — Single Pack.)	8 *	\$17.00	AC
BP58	Replacement Charcoal Filter Pack. Each pack contains three 7-3/4" x 10-1/2" pads. Master pack contains 8 filter packs. (SR610051 — Single Pack)	8 *	\$11.92	AC

Single packs are higher priced.

■ Limited quantities available.

● Item too large to ship via UPS/FedEx. Item shipped common carrier at minimum rates.
 * All pricing reflects the individual item cost. You must order in multiples as indicated.
 ◆ UL listed for use over bathtubs and showers when connected to a GFCI protected branch circuit.

Range Hoods — Under Cabinet

Broan® F40000 Series

Adapt to any installation with these four-way convertible range hoods. An enclosed light and fan/filter assembly makes for easy cleaning.

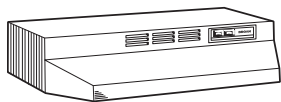

3-1/4" x 10" Duct — Internal Blower
160 CFM — 6.5 Sones Vertical
160 CFM — 6.5 Sones Horizontal
7" Round Duct — Internal Blower
190 CFM — 6.5 Sones

Converts to non-ducted. Includes washable aluminum filter. Non-ducted filter purchased separately.

	Model No.	Description	Std. Pk.	List Price	Code
24"	F402401	White Range Hood	1	\$145.24	LL
	F402404	Stainless Steel Range Hood	1	\$206.48	LL
	F402408	■ Almond Range Hood	1	\$145.24	LL
	F402411	White-on-White Range Hood	1	\$145.24	LL
	F402422	■ Bisque-on-Bisque Range Hood	1	\$145.24	LL
	F402423	Black Range Hood	1	\$145.24	LL
30"	F403001	White Range Hood	1	\$139.30	LL
	F403004	Stainless Steel Range Hood	1	\$198.02	LL
	F403008	Almond Range Hood	1	\$139.30	LL
	F403011	White-on-White Range Hood	1	\$139.30	LL
	F403022	Bisque-on-Bisque Range Hood	1	\$139.30	LL
	F403023	Black Range Hood	1	\$139.30	LL
36"	F403601	White Range Hood	1	\$153.22	LL
	F403604	Stainless Steel Range Hood	1	\$217.82	LL
	F403611	White-on-White Range Hood	1	\$153.22	LL
	F403622	■ Bisque-on-Bisque Range Hood	1	\$153.22	LL
	F403623	Black Range Hood	1	\$153.22	LL
42"	F404201	White Range Hood	1	\$168.52	LL
	F404204	Stainless Steel Range Hood	1	\$239.62	LL
	F404208	■ Almond Range Hood	1	\$168.52	LL
	F404211	White-on-White Range Hood	1	\$168.52	LL
	F404222	■ Bisque-on-Bisque Range Hood	1	\$168.52	LL
	F404223	Black Range Hood	1	\$168.52	LL
	41F	Replacement Non-ducted Filter for F40000, 41000 and 46000 Series range hoods. Master Pack contains 6 filters. (S97007696 — Single Pack)	6 *	\$17.94	AC
	BP29	10-1/2" x 8-3/4" Washable Aluminum Filter for F40000, 40000, 42000 and 46000 Series. Contains 6 filters. (S97006931 — Single Pack)	6 *	\$9.62	AC
	BP87Q	7" Damper for round discharge range hood. (S97018803 — Single Pack)	3 *	\$18.98	AC

Single packs are higher priced.

■ Limited quantities available.

● Item too large to ship via UPS/FedEx. Item shipped common carrier at minimum rates.
* All pricing reflects the individual item cost. You must order in multiples as indicated.
◆ UL listed for use over bathtubs and showers when connected to a GFCI protected branch circuit.

Range Hoods — Under Cabinet

Broan® 42000 Series 7" ROUND DUCTED

High quality, economy level range hood installs as 7" round ducted only. Dishwasher-safe grease filter.



7" Round Duct — Internal Blower
190 CFM — 6.0 Sones Vertical

	Model No.	Description	Std. Pk.	List Price	Code
24"	422401	White Range Hood	1	\$128.80	LL
	422401D	White Range Hood (with damper)	1	\$139.40	LL
	422402	Bisque Range Hood	1	\$128.80	LL
	422404	Stainless Steel Range Hood	1	\$189.36	LL
30"	423001	White Range Hood	1	\$124.30	LL
	423001D	White Range Hood (with damper)	1	\$134.54	LL
	423002	Bisque Range Hood	1	\$124.30	LL
	423004	Stainless Steel Range Hood	1	\$184.82	LL
	423023	Black Range Hood	1	\$124.30	LL
36"	423601	White Range Hood	1	\$128.80	LL
	423601D	White Range Hood (with damper)	1	\$139.40	LL
	423602	Bisque Range Hood	1	\$128.80	LL
	423604	Stainless Steel Range Hood	1	\$189.36	LL
	423608D	■ Almond Range Hood (with damper)	1	\$139.40	LL
	423623	Black Range Hood	1	\$128.80	LL
42"	424201	White Range Hood	1	\$133.36	LL
	424201D	White Range Hood (with damper)	1	\$144.00	LL
	424202	Bisque Range Hood	1	\$133.36	LL
	424204	Stainless Steel Range Hood	1	\$193.86	LL
	BP29	10-1/2" x 8-3/4" Washable Aluminum Filter for F40000, 40000, 42000 and 46000 Series. Contains 6 filters. (S97006931 — Single Pack)	6 *	\$9.62	AC
	BP87Q	7" Damper for round discharge range hood. (S97018803 — Single Pack)	3 *	\$18.98	AC
	T457	7" to 5" duct reducer	1	\$26.78	AC

■ Limited quantities available.

Single packs are higher priced.

- Item too large to ship via UPS/FedEx. Item shipped common carrier at minimum rates.
- * All pricing reflects the individual item cost. You must order in multiples as indicated.
- ◆ UL listed for use over bathtubs and showers when connected to a GFCI protected branch circuit.

Range Hoods — Under Cabinet

Broan® 40000 Series 3-1/4" x 10" DUCTED

High quality, economy level range hood installs as 3-1/4" x 10" ducted only. Dishwasher-safe grease filter.



3-1/4" x 10" Duct — Internal Blower
160 CFM — 6.5 Sones Vertical
160 CFM — 6.5 Sones Horizontal

	Model No.	Description	Std. Pk.	List Price	Code
21"	402101	White Range Hood	1	\$162.24	LL
	402102	Bisque Range Hood	1	\$162.24	LL
	402108 ■	Almond Range Hood	1	\$162.24	LL
24"	402401	White Range Hood	1	\$136.54	LL
	402402	Bisque Range Hood	1	\$136.54	LL
	402404	Stainless Steel Range Hood	1	\$197.10	LL
30"	403001	White Range Hood	1	\$131.98	LL
	403002	Bisque Range Hood	1	\$131.98	LL
	403004	Stainless Steel Range Hood	1	\$192.52	LL
	403023	Black Range Hood	1	\$131.98	LL
36"	403601	White Range Hood	1	\$136.54	LL
	403602	Bisque Range Hood	1	\$136.54	LL
	403604	Stainless Steel Range Hood	1	\$197.10	LL
	403623	Black Range Hood	1	\$136.54	LL
42"	404201	White Range Hood	1	\$141.02	LL
	404202	Bisque Range Hood	1	\$141.02	LL
	BP29	10-1/2" x 8-3/4" Washable Aluminum Filter for F40000, 40000, 42000 and 46000 Series. Contains 6 filters. (S97006931 — Single Pack)	6 *	\$9.62	AC

■ Limited quantities available.

Single packs are higher priced.

Broan® 37000 Series (SHELL ONLY)

Shell utilizes a 40000 Series shell, but contains no fan, light, switches or knockouts.



	Model No.	Description	Std. Pk.	List Price	Code
24"	372401	White Range Hood Shell	1	\$82.34	LL
30"	373001	White Range Hood Shell	1	\$77.80	LL
	373004	Stainless Steel Range Hood Shell	1	\$138.32	LL
36"	373601	White Range Hood Shell	1	\$82.34	LL

● Item too large to ship via UPS/FedEx. Item shipped common carrier at minimum rates.

* All pricing reflects the individual item cost. You must order in multiples as indicated.

◆ UL listed for use over bathtubs and showers when connected to a GFCI protected branch circuit.

Range Hoods — Under Cabinet

Broan® 41000 Series NON-DUCTED

High quality, economy level range hood installs as non-ducted only. Two-speed fan control. Charcoal replacement filter sold separately.



Non-duct — Includes filter

Model No.	Description	Std. Pk.	List Price	Code	
21"	412101	White Non-ducted Range Hood	1	\$165.56	LL
	412102	Bisque Non-ducted Range Hood	1	\$165.56	LL
	412123	Black Non-ducted Range Hood	1	\$165.56	LL
24"	412401	White Non-ducted Range Hood	1	\$139.86	LL
	412402	Bisque Non-ducted Range Hood	1	\$139.86	LL
	412404	Stainless Steel Non-ducted Range Hood	1	\$200.40	LL
30"	413001	White Non-ducted Range Hood	1	\$135.30	LL
	413002	Bisque Non-ducted Range Hood	1	\$135.30	LL
	413004	Stainless Steel Non-ducted Range Hood	1	\$195.86	LL
	413023	Black Non-ducted Range Hood	1	\$135.30	LL
36"	413601	White Non-ducted Range Hood	1	\$139.86	LL
	413602	Bisque Non-ducted Range Hood	1	\$139.86	LL
	413604	Stainless Steel Non-ducted Range Hood	1	\$200.40	LL
	413623	Black Non-ducted Range Hood	1	\$139.86	LL
42"	414201	White Non-ducted Range Hood	1	\$144.40	LL
	414202	Bisque Non-ducted Range Hood	1	\$144.40	LL
	414204	Stainless Steel Non-ducted Range Hood	1	\$204.94	LL
41F	Replacement Non-ducted Filter for F40000, 41000 and 46000 Series range hoods. Master Pack contains 6 filters. (S97007696 — Single Pack)	6 *	\$17.94	AC	

■ Limited quantities available.

Single packs are higher priced.

Range Hoods — Accessories

Broan® SP and EP Backsplashes (24" HIGH)

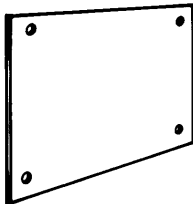

All Backsplashes furnished in two colors — one per side except stainless steel.

Economy (EP) Backsplashes are packaged 4 per carton and must be ordered in multiples of 4. Prices shown are for each wall shield.

Model No.	Description	Std. Pk.	List Price	Code	
24"	SP240108	White/Almond Backsplash	1	\$40.46	AC
	SP2404	Stainless Steel Backsplash	1	\$102.80	AC
	SP240223	Bisque/Black Backsplash	1	\$40.46	AC
30"	SP300108	White/Almond Backsplash	1	\$40.46	AC
	SP3004	Stainless Steel Backsplash	1	\$102.80	AC
	SP300223	Bisque/Black Backsplash	1	\$40.46	AC
36"	SP360108	White/Almond Backsplash	1	\$47.12	AC
	SP3604	Stainless Steel Backsplash	1	\$109.22	AC
	SP360223	Bisque/Black Backsplash	1	\$47.12	AC
42"	SP420108 ■	White/Almond Backsplash	1	\$54.74	AC
	SP4204	Stainless Steel Backsplash	1	\$126.72	AC
	SP420223 ■	Bisque/Black Backsplash	1	\$54.74	AC
30"	EP300108 ■	White/Almond Backsplash	4 *	\$36.66	AC
	EP300223	Bisque/Black Backsplash	4 *	\$36.66	AC

■ Limited quantities available.

Note: Backsplashes are accessories and cannot be combined with any other product groups to meet volume requirements.

● Item too large to ship via UPS/FedEx. Item shipped common carrier at minimum rates.

* All pricing reflects the individual item cost. You must order in multiples as indicated.

◆ UL listed for use over bathtubs and showers when connected to a GFCI protected branch circuit.

Range Hoods — Accessories

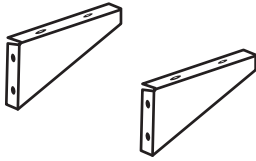

Broan® Range Hood Wall Brackets

Designed for use with 37000, 40000, 41000, 42000, 43000, 46000, 52000, 88000, 89000, AP1 (ducted only), F40000, QL1, QS1, QS2 (36" and 42" only), QS3 (36" and 42" only), QT20000 and RP1 Series.

Model No.	Description	Std. Pk.	List Price	Code
35	Wall Hanging Kit for mounting all hoods to wall when cabinets are not used	1	\$31.04	AC

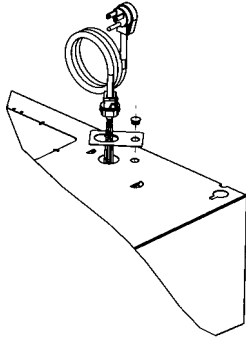

Broan® Range Hood Electrical Cord Connection Kit

Designed for easy electrical wiring of range hoods. Can be used with Broan, NuTone, Nautilus or Kenmore range hoods.

Model No.	Description	Std. Pk.	List Price	Code
HCK44	Power Cord Kit on individual display card	10 *	\$22.40	AC
HCK44D	Power Cord Kit individual packaged in a polybag. Master Pack — 50.	50 *	\$14.72	AC

Broan: 40000, 41000, 42000, 43000, 46000, BCDF1, BCDJ1, BCSD1, BCSEK1, BKDB1, BKDEG1, BKSA1, BKSH1, BNDF1, BNSC1, BPDP1, BQDD1, BOLA1, BOSJ1, CLDA1, CLDH1, CLSC1, CRDE1, CRSF1, EPLEC1 and EQLD1

NuTone: RL, ACS, AHDA1, AHSA1, AVDF1, AVSF1 and NPDP1

Kenmore: 5094, 5104, 5134, 5164, 5184, 5324, 5334, 5128, 5139, 5141, 5129, 5126, 5135 and 5140

Broan® Range Hood Lamp Accessories

Model No.	Description	Std. Pk.	List Price	Code
PAR20	Halogen Bulb; 120V, 50W for QS1, QS2, QS3 and RMIP Series	6 *	\$23.90	AC
GU10	Halogen Bulb; 120V, 50W for E66, RMP, E60, E64, AP, QP2, QP3, QP4 and RP Series	10 *	\$17.58	AC
GU1035	Halogen Bulb; 120V, 35W for EI59, EW58, EW56, QML and QP1 Series	10 *	\$16.40	AC

Trash Compactor Accessories

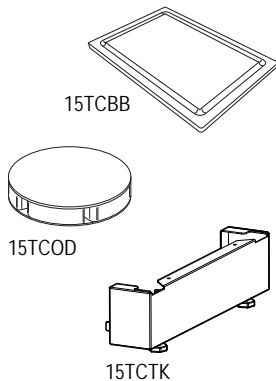

Broan® Elite Trash Compactor Accessories

Model No.	Description	Std. Pk.	List Price	Code
15TCBB	■ Cutting Board for 15" compactor	1	\$170.10	CP
15TCBL	15" Compactor Bags, 12 count	1	\$25.94	CP
15TCOD	Odor Control Disc	1	\$55.44	CP
15TCTK	■ Free-standing Toe Kick Kit	1	\$24.52	CP
1006	12" Compactor Bags (includes 10 packs of 12)	10 *	\$20.24	CP

■ Limited quantities available.

- Item too large to ship via UPS/FedEx. Item shipped common carrier at minimum rates.
- * All pricing reflects the individual item cost. You must order in multiples as indicated.
- ◆ UL listed for use over bathtubs and showers when connected to a GFCI protected branch circuit.

Ventilation Fans — ULTRA™



NuTone® ULTRA™ Pro Fan and Fan/Light Series

The preferred install choice for professionals to deliver quiet performance *ULTRAQuick™* installation, with no attic access required. QStream™ sound technology features airflow-smoothing baffles to reduce noise caused by turbulence and QFlow™ sound technology that removes the duct damper from the airstream to reduce static pressure. 4" duct for ideal retrofit installation and ENERGY STAR® certified. 10-1/2" x 11-3/8" x 7-5/8" housing fits 2" x 8" ceiling construction. UL Listed for use over bathtubs and showers when connected to a GFCI protected branch circuit.

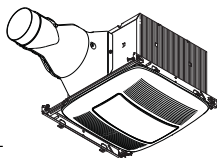
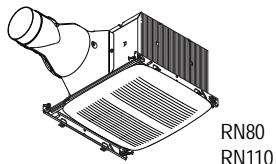

Model No.	Description	Std. Pk.	List Price	Code
Fans				
RN80	80 CFM, <0.3 Sones, ENERGY STAR Fan	1	\$272.54	HP
RN110	110 CFM, 0.6 Sones, ENERGY STAR Fan	1	\$302.30	HP
Fan/Light				
RN80L	80 CFM, <0.3 Sones, ENERGY STAR Fan/Light, two energy efficient 18W GU24 Fluorescent Lights (bulbs included)	1	\$398.32	HP
RN110L	110 CFM, 0.8 Sones, ENERGY STAR Fan/Light, two energy efficient 18W GU24 Fluorescent Lights (bulbs included)	1	\$424.80	HP



All models are ENERGY STAR certified products.

Ventilation Fans — QT Series™

Broan SmartSense® Intelligent Ventilation System

The intelligent fan control system creates an integrated residential exhaust ventilation system using Broan's industry leading ventilation control technology and award winning QTxE fans. The Broan SmartSense system uses Broan's Link-Logic™ control technology powered by INSTEON™, a powerful communication technology to monitor everyday manual fan usage throughout the home. Broan SmartSense calculates additional ventilation required by Green Building and ASHRAE Standard 62 related requirements and automatically controls installed fans to achieve proper ventilation. SSQTxE080 and SSQTxE110 fans can provide a single fan solution for small apartments or mix and matched for a customized, integrated ventilation system.

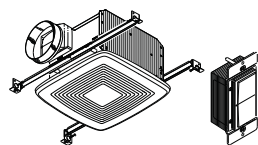

Model No.	Description	Std. Pk.	List Price	Code
SSQTxE080	80 CFM SmartSense Fan with Control	1	\$298.54	HV
SSQTxE110	110 CFM SmartSense Fan with Control	1	\$331.60	HV
SMSCPLR †	SmartSense Phase Coupler	1	\$47.74	AR

† The SmartSense Phase Coupler is only required when fans are located on separate phases of power. If fans are on the same circuit or phase, the phase coupler is not necessary.

Broan® Ventilation Fan with Sensonic™ Speakers and Speaker Kit

Unlike wireless speakers that require counter space, Sensonic speakers with Bluetooth® wireless technology fill your room with rich sound from above. From hard rock to news talk, play any audio through the dual high-fidelity speakers and enjoy entertainment and privacy at the touch of a button. It's brilliant audio performance concealed behind the fan grille.

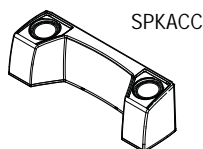
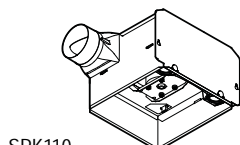

Model No.	Description	Std. Pk.	List Price	Code
SPK110	Sensonic Speaker Fan; 110 CFM, 1.0 Sones	1	\$410.64	HV
SPKACC	Sensonic Speaker Accessory	1	\$189.26	AC

- Item too large to ship via UPS/FedEx. Item shipped common carrier at minimum rates.
- * All pricing reflects the individual item cost. You must order in multiples as indicated.
- ◆ UL listed for use over bathtubs and showers when connected to a GFCI protected branch circuit.

NuTone® QT Series™ Fan and Fan/Light/Night Light Series (QTXEN Models)

The industry's quietest, most powerful and stylish fans with a 3 year warranty. 6" ducting for superior performance and ENERGY STAR certified. Includes hanger bar system for fast and flexible installations for all types of construction. 10-1/2" x 11-3/8" x 7-5/8" high housing. 12-7/8" x 13-5/8" grille (QTXEN fans) and 13" x 14" grille (QTXEN fan/lights). Type IC.

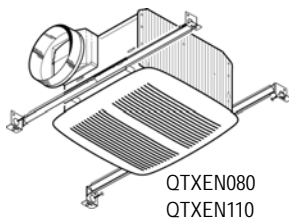

QTXEN080
QTXEN110

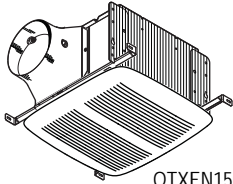

QTXEN150

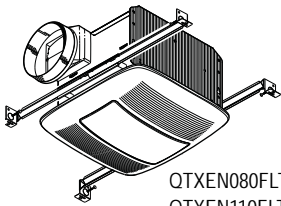

QTXEN080FLT
QTXEN110FLT

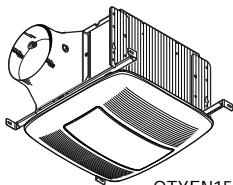

QTXEN150FLT

Model No.	Description	Std. Pk.	List Price	Code
Fans				
QTXEN080 ◆	80 CFM, 0.3 Sones, ENERGY STAR Fan	1	\$262.78	HV
QTXEN110 ◆	110 CFM, 0.7 Sones, ENERGY STAR Fan	1	\$297.34	HV
QTXEN150 ◆	150 CFM, 1.4 Sones, ENERGY STAR Fan	1	\$356.16	HV
Fan/Light/Night Light				
QTXEN080FLT ◆	80 CFM, 0.3 Sones, ENERGY STAR Fan with 36W Fluorescent Light (2-18 watt GU24 bulbs included) and 4W Night Light (bulb not included)	1	\$387.24	HV
QTXEN110FLT ◆	110 CFM, 0.7 Sones, ENERGY STAR Fan with 36W Fluorescent Light (2-18 watt GU24 bulbs included) and 4W Night Light (bulb not included)	1	\$428.70	HV
QTXEN150FLT ◆	150 CFM, 1.4 Sones, ENERGY STAR Fan with 36W Fluorescent Light (2-18 watt GU24 bulbs included) and 4W Night Light (bulb not included)	1	\$501.36	HV



All models are ENERGY STAR certified products.

NuTone® LunAura Collection Ambient Ultra Silent™ Fan/Light

Great for any room in the home. The benefits of powerful, ultra silent, ENERGY STAR certified ventilation. Now come with a soft beautiful blue LED night light which delivers improved safety and navigation as well as a calming spa setting.

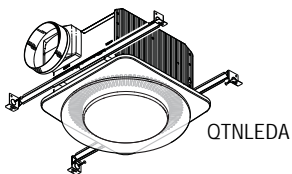

QTNLEDA

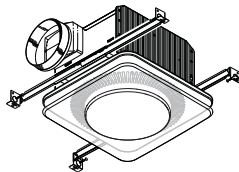

QTNLEDB

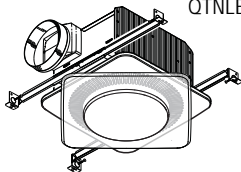

Model No.	Description	Std. Pk.	List Price	Code
QTNLEDA	110 CFM, 0.7 Sones, ENERGY STAR Fan/Light/Night Light with 36 watt (2-18) GU24 bulbs included. 6" or 4" duct. Round design.	1	\$440.24	NF
QTNLEDB	110 CFM, 0.7 Sones, ENERGY STAR Fan/Light/Night Light with 36 watt (2-18) GU24 bulbs included. 6" or 4" duct. Square/Diamond design.	1	\$440.24	NF



All models are ENERGY STAR certified products.

- Item too large to ship via UPS/FedEx. Item shipped common carrier at minimum rates.
- * All pricing reflects the individual item cost. You must order in multiples as indicated.
- ◆ UL listed for use over bathtubs and showers when connected to a GFCI protected branch circuit.

Ventilation Fans — InVent™ Series

NuTone® InVent™ Series Ventilation Fans

New, versatile housing platform that marks a revolution of our mid-range ventilation fans and allows for easy installation in both new construction and retrofit applications. 10" x 9-1/4" x 5-3/4" housing features foldable mounting ears for easy, room-side replacement. 4" duct connector mounts from the inside of the housing and features a new damper technology, improving air tightness scores.

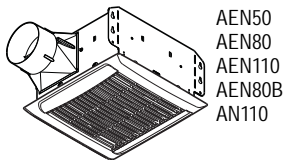

AEN50
AEN80
AEN110
AEN80B
AN110

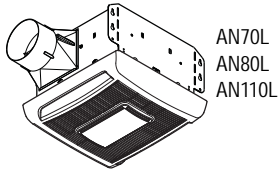

AN70L
AN80L
AN110L

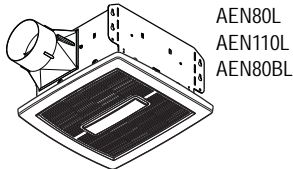

AEN80L
AEN110L
AEN80BL

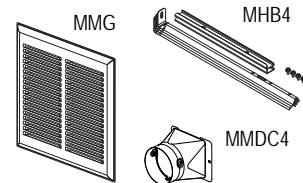

MMG

MHB4



MMDC4

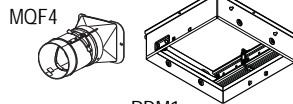

MQF4

RDM1

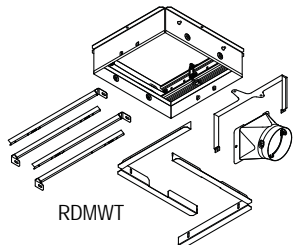

RDMWT

Model No.		Description	Std. Pk.	List Price	Code
Ventilation Fans					
AN110	Ω	110 CFM, 3.0 Sones	1	\$173.34	HM
AEN50	Ω	50 CFM, 0.5 Sones, ENERGY STAR Fan	1	\$173.34	HM
AEN80	Ω	80 CFM, 0.8 Sones, ENERGY STAR Fan	1	\$249.60	HM
AEN110	Ω	110 CFM, 1.0 Sones, ENERGY STAR Fan	1	\$277.34	HM
AEN80B	Ω	80 CFM, 1.5 Sones, ENERGY STAR Fan	1	\$121.34	HM
Ventilation Fan/Lights					
AN70L		70 CFM, 2.0 Sones, Fan/Light	1	\$152.54	HM
AN80L		80 CFM, 1.0 Sones, Fan/Light	1	\$364.00	HM
AN110L		110 CFM, 1.3 Sones, Fan/Light	1	\$398.68	HM
AEN80BL	Ω	LED Light, 80 CFM, 1.5 Sones, ENERGY STAR Fan/Light	1	\$225.32	HM
AEN80L	Ω	LED Light, 80 CFM, 0.8 Sones, ENERGY STAR Fan/Light	1	\$416.00	HM
AEN110L	Ω	LED Light, 110 CFM, 1.0 Sones, ENERGY STAR Fan/Light	1	\$450.68	HM
Accessories					
MHB4		Hanger Bars	1	\$20.80	AC
MMDC4	■	Metal Duct Connector	1	\$26.00	AC
MMG		Metal Grille, White	1	\$45.08	AC
MQF4		QFlow Duct Connector	1	\$20.80	AC
RDM1		Radiation Damper	1	\$173.34	HM
RDMWT		Radiation Damper for UL wood truss assembly listings L521, L528, L546, L558, L562, L574, L576, L581, L583, L585, P522, P533, P538, P545 and P547.	1	\$173.34	HM

Ω Works with Model RDM1 and RDMWT radiation damper.

■ Limited quantities available.



Select models are ENERGY STAR certified products — see product description

- Item too large to ship via UPS/FedEx. Item shipped common carrier at minimum rates.
- * All pricing reflects the individual item cost. You must order in multiples as indicated.
- ◆ UL listed for use over bathtubs and showers when connected to a GFCI protected branch circuit.

NuTone® Recessed Fan/Lights

Recessed lights are popular lighting solutions. But NuTone took it a step further by incorporating powerful ventilation in the same design. Our new fan/lights disappear into the ceiling with other recessed lights, so they are practical decorating solutions for any room in the house. In the bath they control humidity, and in a utility room, kitchen or high-traffic family room they keep the air fresh and comfortable. 12-3/4" x 8-1/4" x 6-3/4" high housing. 7-3/8" round trim. Damper/duct connector fits 4" duct. Type IC. Fits 2" x 6" ceiling construction.

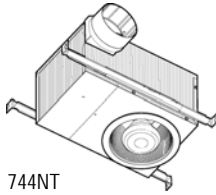

744NT
744LEDNT

Model No.	Description	Std. Pk.	List Price	Code
744NT	◆ Recessed Fan/Light, 70 CFM, 1.5 Sones, 6" white trim. Uses 75W max R30 or BR30 bulb for standard applications.	1	\$178.84	NF
744LEDNT	◆ ENERGY STAR Recessed Fan/LED Light, 70 CFM, 1.5 Sones, 6" white trim. Uses 10W BR30 LED bulb (bulb included).	1	\$320.30	NF



Select models are ENERGY STAR certified products.

NuTone® LoProfile™ Ventilation Fan

The new NuTone LoProfile™ fan is our latest solution for installations where conventional ventilation simply won't fit. Where multi-family applications require it, the LoProfile™ fan is narrow enough to be installed in a wall between 2 x 4 studs. When plumbing or electrical obstructions are found behind the drywall in ceiling remodel applications our LoProfile™ fan can still fit without having to move anything. And that means most any room with space constraints can have powerful, quiet and efficient ventilation.

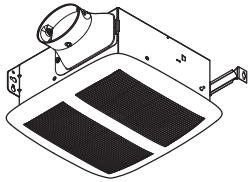

Model No.	Description	Std. Pk.	List Price	Code
LPN80	ENERGY STAR Fan, 80 CFM, 1.0 Sones	1	\$103.50	HV



ENERGY STAR certified product.

- Item too large to ship via UPS/FedEx. Item shipped common carrier at minimum rates.
- * All pricing reflects the individual item cost. You must order in multiples as indicated.
- ◆ UL listed for use over bathtubs and showers when connected to a GFCI protected branch circuit.

Ventilation Fans

NuTone® EZFit Ventilation Fan

EZFit ventilation fan easily replaces your existing fan in 40 minutes entirely from the room-side. EZLock tabs secure fan directly to drywall, eliminating need for joist/truss mounting. EZConnect wiring connectors eliminate clumsy wire nuts. EZDuct connector allows attachment of existing duct from inside housing so no need to go in the attic. Slim housing fits in virtually all ceiling spaces. Housing dimensions: 12" L x 10-1/2" W x 5" H. Grille dimensions: 12-1/2" L x 13" W.

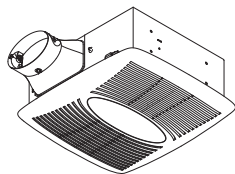

Model No.	Description	Std. Pk.	List Price	Code
EZ80N	ENERGY STAR Ventilation Fan. 80 CFM, 1.0 Sones	1	\$246.06	HV



ENERGY STAR certified product.

NuTone Basic® Fans

Molded plastic impeller, two-pole motor, 7-1/4" x 7-1/2" x 3-5/8" high galvanized steel housing for ceiling or wall installation. Spring mounted 8-11/16" x 9" plastic grille. Damper/duct connector fits 3" round duct. Snap-in motor plate requires no tools for installation or removals. Fits 2" x 4" ceiling or wall construction.

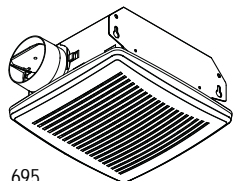

695
696N

Model No.	Description	Std. Pk.	List Price	Code
695	◆ 70 CFM, 6.0 Sones. Fan — 3" Duct	1	\$61.84	LV
696N	◆ 50 CFM, 4.0 Sones. Fan — 3" Duct	1	\$46.98	LV

All models also available in project packs, see Page 57.

NuTone® Fan/Lights

Powerful fans remove stale air and damaging moisture. 9" x 9" x 6" housing. Damper/duct connector fits 4" round duct. Bright lighting and 7W night light. All models are Type IC. Bulbs not included.

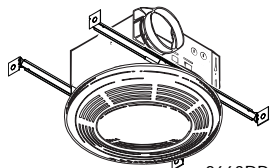

8663RP
8664RP

Model No.	Description	Std. Pk.	List Price	Code
8663RP	100 CFM, 3.5 Sones. Fan/Light/Night Light, Round White Grille with glass lens, 100W max Incandescent Light, 7W Night Light.	1	\$253.84	HV
8664RP	100 CFM, 3.5 Sones. Fan/Light, Round White Grille with glass lens, 100W max Incandescent Light.	1	\$228.84	HV

NuTone® Fan/Lights

Operate fan and light together or independently. Damper/duct connector fits 4" round duct. All models are Type IC. Bulbs not included. Fits 2" x 6" ceiling construction.

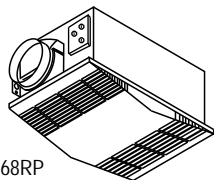

668RP

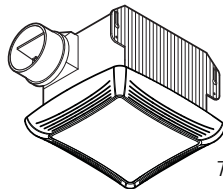

763

Model No.	Description	Std. Pk.	List Price	Code
668RP	◆ 70 CFM, 4.0 Sones. Fan with 100W max incandescent light (bulb not included) — 4" Duct.	1	\$146.70	LV
763	◆ 50 CFM, 2.5 Sones. Fan with 100W max incandescent light (bulb not included) — 4" Duct.	1	\$98.24	LV
MCB2	Mounting Channel/Brackets for Single Packs (2 channels/4 brackets). Works with Model 763.	1	\$15.54	AC

Select models available in project packs, see Page 57.

- Item too large to ship via UPS/FedEx. Item shipped common carrier at minimum rates.
- * All pricing reflects the individual item cost. You must order in multiples as indicated.
- ◆ UL listed for use over bathtubs and showers when connected to a GFCI protected branch circuit.

NuTone® Bath Fan Upgrade Kit

The patented economy fan Bath Fan Upgrade Kit improves performance, reduces the sound level, and upgrades the appearance of your economy fan in 10 minutes. Provide easy upgrade for economy fan without replacing the entire housing, rewiring and reconnecting the duct. Helps ensure tenant/homeowner is using the fan when needed most. Reduces sound up to 50%, improves air movement up to 20% and helps control humidity that causes mold and mildew. Kit includes quiet fan motor, grille, wrench and two motor plates.



690NT

Model No.	Description	Std. Pk.	List Price	Code
690NT	◆ 60 CFM, 3.0 Sones Fan, Economy Upgrade Kit	1	\$62.12	UK

The 690NT Upgrade Kit replaces the models below.

Model No.	Housing Dimension
NuTone: 693, 695 & 696N	7-1/2" x 7-1/4" or 8" x 7-1/4"
Broan: 670, 671, 688 & 689	7-1/2" x 7-1/4" only 8" x 8-1/4" are not compatible.
Nautilus: N671 & N688	

Economy LED Upgrade Grille

The FG500N/FG500NS is a unique lighted ventilation fan grille which allows upgrading a non-lighted ventilation fan or tired incandescent fan/light into a sleek fan/light with bright, efficient LED lighting quickly and easily.

Model No.	Description	Std. Pk.	List Price	Code
FG500N	NuTone LED Upgrade Grille (4-Pack in Retail Merchandising Tray)	4 *	\$46.94	AC
FG500NS	NuTone LED Upgrade Grille (Single Unit)	1	\$46.94	AC

NuTone® Duct-Free Fan

No ductwork necessary! Ideal for powder rooms and closets. Fits in 2" x 4" construction.

Model No.	Description	Std. Pk.	List Price	Code
682NT	Duct-Free Fan with plastic grille. Includes long lasting, easy to replace, activated charcoal filter. Easy snap-in mounting.	1	\$70.32	LV

● Item too large to ship via UPS/FedEx. Item shipped common carrier at minimum rates.
 * All pricing reflects the individual item cost. You must order in multiples as indicated.
 ◆ UL listed for use over bathtubs and showers when connected to a GFCI protected branch circuit.

NuTone® InVent™ Series Project Packs (Housing and Finish Packs)

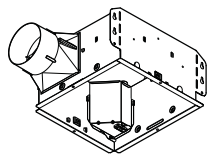

AN000HF

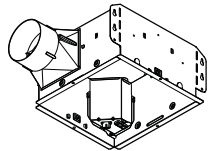

AN000HL

Model No.	Description	Std. Pk.	List Price	Code
Housing Packs				
AN000HF	Ventilation Fan Housing Pack	4 *	\$24.28	HM
AN000HL	Ventilation Fan/light Housing Pack	4 *	\$24.28	HM
Finish Packs				
AEN50F	50 CFM, 0.5 Sones, ENERGY STAR Finish Pack	4 *	\$149.08	HM
AEN80BF	80 CFM, 1.5 Sones, ENERGY STAR Finish Pack	4 *	\$97.08	HM
AEN80BLF	LED Light, 80 CFM, 1.5 Sones, ENERGY STAR Finish Pack	4 *	\$201.06	HM
AEN80F	80 CFM, 0.8 Sones, ENERGY STAR Finish Pack	4 *	\$225.34	HM
AEN80LF	LED Light, 80 CFM, 0.8 Sones, ENERGY STAR Finish Pack	4 *	\$391.74	HM
AEN110F	110 CFM, 1.3 Sones, ENERGY STAR Finish Pack	4 *	\$253.08	HM
AN70LF	70 CFM, 2.0 Sones, Finish Pack	4 *	\$128.28	HM
AN80HDF	80 CFM, 2.0 Sones, Metal Grille, Finish Pack	4 *	\$176.80	HM
AN110F	110 CFM, 3.0 Sones, Finish Pack	4 *	\$149.08	HM

■ Limited quantities available.



Select models are ENERGY STAR certified products — see product description.

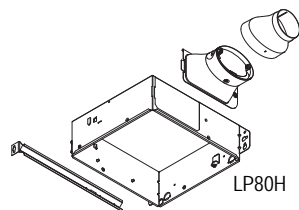

LP80H

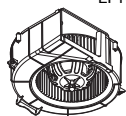

LPN80F

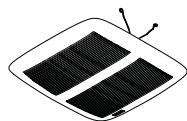

NuTone® LoProfile™ Project Pack

The new NuTone LoProfile™ fan is our latest solution for installations where conventional ventilation simply won't fit. Where multi-family applications require it, the LoProfile™ fan is narrow enough to be installed in a wall between 2 x 4 studs. When plumbing or electrical obstructions are found behind the drywall in ceiling remodel applications, our LoProfile™ fan can still fit without having to move anything. And that means most any room with space constraints can have powerful, quiet and efficient ventilation. Project Packs offer availability to buy housings for rough-in and motor/blower assemblies and grille later for finishing.

Model No.	Description	Std. Pk.	List Price	Code
LP80H	Housing Pack for LPN80	4 *	\$25.84	HV
LPN80F	ENERGY STAR Finish Pack. Motor and Grille Assembly. 80 CFM, 1.0 Sones.	4 *	\$81.00	HV



ENERGY STAR certified products.

- Item too large to ship via UPS/FedEx. Item shipped common carrier at minimum rates.
- * All pricing reflects the individual item cost. You must order in multiples as indicated.
- ◆ UL listed for use over bathtubs and showers when connected to a GFCI protected branch circuit.

NuTone® Radiation Damper Accessory Kit

Model No.	Description	Std. Pk.	List Price	Code
RDFQF	Radiation damper accessory that works with Models SSQTXE110, SSQTXE080, QTXEN080 and QTXEN110.	1	\$126.08	HV
RDFQL	Radiation damper accessory that works with Models QTXEN080FLT and QTXEN110FLT. Also works with Model QTXE110S when used with RDJUMPO accessory.	1	\$126.08	HV
RDFU	Radiation damper accessory that works with Models QTXEN150, QTXEN150FLT, RN80 and RN110. Also works with Models RN80L and RN110L when used with RDJUMPU or RDJUMPU1.	1	\$126.08	HP
RDFUWT	Radiation damper accessory that works with Models QTXEN150, QTXEN150FLT, RN80 and RN110. Also works with Models RN80L, RN110L and XN110HL when used with RDJUMPU accessory. For UL wood truss assembly listings L521, L528, L546, L558, L562, L574, L576, L581, L583, L585, P522, P533, P538, P545 and P547. Available May, 2017.	1	\$126.08	HP
RDJ1	Radiation damper accessory with metal grille and metal duct connector (no housing). Works with 50NT, 80NT, HD50NT and HD80NT.	1	\$147.02	HV
RDF1	Radiation damper. Works with ULTRA® Series non-sensing fans (not fan/lights) and LPN80.	1	\$126.08	HP
<u>Accessories</u>				
RDJUMPO	Wiring jumper kit required for use with RDFQL when used with Models QTXEN110S and QTXEN110SFLT.	1	\$8.78	AC
RDJUMPU	Wiring jumper kit required for use with RDFU when used with Models XN110HL, ZN110HL, ZN80ML, ZN110ML, XN50L, XN80L, XN110L, ZN80L, ZN110L, XN110H, ZN110H, ZN80M and ZN110M.	1	\$17.58	AC

- Item too large to ship via UPS/FedEx. Item shipped common carrier at minimum rates.
- * All pricing reflects the individual item cost. You must order in multiples as indicated.
- ◆ UL listed for use over bathtubs and showers when connected to a GFCI protected branch circuit.

NuTone® Fan & Fan/Light Project Packs

NuTone's Project Packs offer a variety of housings packed and sold separately from motor assembly and grille. You can buy housings for rough-in ... by assemblies and grilles later for finishing.

Fan/Light Project Packs — Fits 2" x 6" Ceiling Construction

Model No.	Description	Std. Pk.	List Price	Code
763F	50 CFM, 2.5 Sones, Fan/Light Finish Pack	4 *	\$81.18	LV
763H	50 CFM, 2.5 Sones, Fan/Light Finish Pack	4 *	\$17.06	LV

Basic Fan Project Packs — Fits 2" x 4" Ceiling or Wall Construction

Model No.	Description	Std. Pk.	List Price	Code
690RA	Housing Pack. Housing for 695RB and 696RNB.	6 *	\$10.38	LV
690RMTLA	Series "A" Unit with Metal Duct Collar. Housing for 696RNB and 695RB (replaces 690MTL).	6 *	\$24.16	LV
695RB	◆ Finish Pack. Fan Motor/Grille Assembly. 70 CFM, 6.0 Sones. Uses 690RA housing pack.	6 *	\$51.46	LV
696RNB	◆ Finish Pack. Fan Motor/Grille Assembly. 50 CFM, 4.0 Sones. Uses 690RA housing pack.	6 *	\$36.60	LV

- Item too large to ship via UPS/FedEx. Item shipped common carrier at minimum rates.
- * All pricing reflects the individual item cost. You must order in multiples as indicated.
- ◆ UL listed for use over bathtubs and showers when connected to a GFCI protected branch circuit.

Ventilation Fans — Remote In-Line

NuTone® In-Line Fans

Remote mounted for adaptable and quiet ventilation.

Model No.	Description	Std. Pk.	List Price	Code
ILF120	4" — 110 CFM In-Line Fan, ENERGY STAR certified	1	\$333.78	HV
ILF130	5" — 130 CFM In-Line Fan, ENERGY STAR certified	1	\$349.66	HV
ILF250	6" — 250 CFM In-Line Fan, ENERGY STAR certified	1	\$365.56	HV
ILRF	4"5" Radon In-Line Fan	1	\$323.06	HV



Select models are ENERGY STAR certified products — see product description.

NuTone® In-Line Fan Kits (Complete Installation Kits)

Kit includes all components to install a single dual point exhaust system (except wall control, wire and ducting). Each kit includes fan, damper and duct clamps.

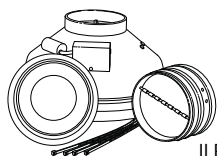

ILFK120
ILFK130
ILFK250

Model No.	Description	Std. Pk.	List Price	Code
ILFK120	4" — 110 CFM In-Line Fan/Grille — Kit, ENERGY STAR certified	1	\$365.56	HV
ILFK130	5" — 130 CFM In-Line Fan/Grille — Kit, ENERGY STAR certified	1	\$381.48	HV
ILFK250	6" — 250 CFM In-Line Fan/Grille — Kit, ENERGY STAR certified	1	\$413.22	HV
ILFK2502	6" — 250 CFM In-Line Fan/Grille — Kit (Includes Y-Adapter and two grilles), ENERGY STAR certified	1	\$476.84	HV



Select models are ENERGY STAR certified products — see product description.

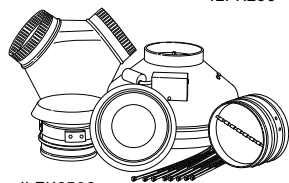

ILFK2502

NuTone® In-Line Fan Accessories

Model No.	Description	Std. Pk.	List Price	Code
CVG4	4" Grille	1	\$36.80	AC
CVG6	6" Grille	1	\$49.46	AC
FY6	6" x 6" x 6" Y-Adapter	1	\$48.04	AC

- Item too large to ship via UPS/FedEx. Item shipped common carrier at minimum rates.
- * All pricing reflects the individual item cost. You must order in multiples as indicated.
- ◆ UL listed for use over bathtubs and showers when connected to a GFCI protected branch circuit.

Ventilation Fans — Heater Combinations

NuTone® QT Series™ Heater/Fan/Light

Powerful heating, lighting and ventilation available at the touch of a switch. Quiet, high output 1500 watt heater with exclusive PowerHeat™ design. Requires a dedicated 20 amp circuit. 3 year warranty. 6" ducting for superior performance. 17-5/8" x 11-3/8" x 7-5/8" high housing with hanger bar system. 20" x 15" grille. Fits 2" x 8" ceiling construction.

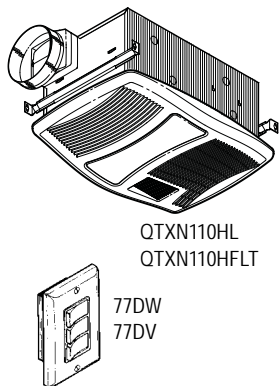

Model No.	Description	Std. Pk.	List Price	Code
QTZN110HL	110 CFM, 0.9 Sones, Fan with 1500W heater, 2-60W max incandescent lights and 7W night light (bulbs not included). Recommend 77 Series switch.	1	\$570.46	HV
QTZN110HFLT	110 CFM, 0.9 Sones, Fan with 1500W heater, 2-18W high efficiency, GU24 based fluorescent light (bulbs included) and 7W night light (bulb included) Recommend 77 Series switch.	1	\$634.76	HV
77DW / 77DV	Three-Switch Control for use with sensing Fan/Lights (top switch provides three settings for sensor On/Auto/Off), remaining switches control light, night light and QT Heater/Fan/Light/Night Light (top switch controls light and night light, remaining switches control fan and heater).	1	\$46.38	AC

NuTone® Directionally-Adjustable Heater with Fan and Light

These heaters feature 1500 watts of powerful, directionally-adjustable heat along with 100 CFM of ventilation at only 2.0 sones. They have 4" ducting and fit in 2" x 6" ceiling construction. Attractive grilles are 17-1/2" x 11-1/2" covering a 16" x 10-1/4" x 5-7/8" housing.

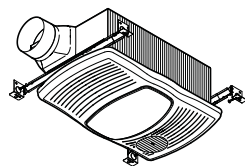

Model No.	Description	Std. Pk.	List Price	Code
765HL	Features 100W max incandescent lighting (bulb not included)	1	\$316.86	LV
765HFL	Features 27W fluorescent lighting (bulb included)	1	\$381.18	LV

NuTone® Heater Combinations with Wall Switch Included

Comfort and convenience combined. Produces instant heat when needed. Select a heater with ventilation fan and/or light with night light (bulbs not included). Housing sizes are noted below and all fit in 2" x 8" ceiling construction.

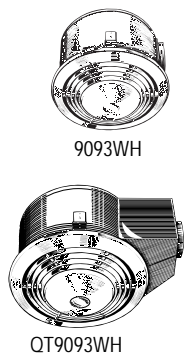

Model No.	Description	Std. Pk.	List Price	Code
9093WH	70 CFM, 3.5 Sones, Combination fan with 1500W heater, 100W incandescent light, 7W night light and white enamel grille. Includes a four-function wall switch. 4" duct connector.	1	\$431.28	HV
QT9093WH	110 CFM, 3.0 Sones, Combination fan with 1500W heater, 100W max incandescent light, 7W night light and white enamel grille. Includes a four-function wall switch. 4" duct connector.	1	\$527.94	HV

Rough-in housing sizes: 9093WH — 15-3/8" dia. x 7-1/2"
QT9093WH — 13-1/4" dia. x 7-1/2"

- Item too large to ship via UPS/FedEx. Item shipped common carrier at minimum rates.
- * All pricing reflects the individual item cost. You must order in multiples as indicated.
- ◆ UL listed for use over bathtubs and showers when connected to a GFCI protected branch circuit.

Ventilation Fans — Heater Combinations

NuTone® Heater Combinations

1300W heating provides optimum performance in smaller spaces. Attractive grille styling. Duct connector with damper fits 4" round duct. 7-7/8" x 14-5/8" x 5-5/8" high housing fits in 2" x 6" ceiling construction.

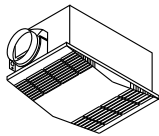

Model No.	Description	Std. Pk.	List Price	Code
605RP	70 CFM, 4.0 Sones, Exhaust fan with 1300W heater	1	\$225.22	LV
665RP	70 CFM, 4.0 Sones, Exhaust fan with 1300W heater and 100W incandescent light (bulb not included).	1	\$227.16	LV

NuTone® Bulb Heaters and Heater/Fans

Produce instant warmth with standard BR40/R40 size 250-watt infrared bulbs (not included). Attractive molded plastic grilles. Damper/duct connector fits 4" round duct (Models 9417DN and 9427P). Models 9412D and 9417DN grilles measure 10-1/4" x 10-1/4". Models 9422P and 9427P grilles measure 10-1/4" x 15-5/8". Housing sizes are noted below. Includes adjustable hanger bar system that spans up to 24". Fits in 2" x 8" ceiling construction.

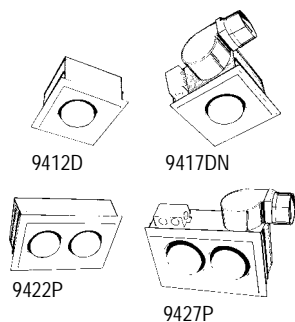

Model No.	Description	Std. Pk.	List Price	Code
9412D	Single 250W Bulb Heat — Non IC	1	\$53.78	HV
9417DN	Single 250W Bulb Heat with 70 CFM, 4.0 Sones Exhaust Fan — Type IC, UL listed for 60°C wiring (retrofit)	1	\$112.12	HV
9422P	Double 250W Bulb Heat Lamp — Type IC	1	\$89.48	HV
9427P	Double 250W Bulb Heat with 70 CFM, 4.0 Sones Exhaust Fan — Type IC, UL listed for 60°C wiring (retrofit)	1	\$149.60	HV

Rough-in housing sizes: 9412D — 8-3/8" x 8-1/8" x 6"
 9417DN — 8-3/8" x 8-1/8" x 6-3/8"
 9422P — 8-3/8" x 14-1/4" x 6"
 9427P — 8-3/8" x 14-1/4" x 6-3/8"

Ventilation Fans — Utility

NuTone® — Vertical Discharge Fan

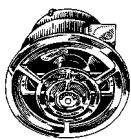

Model No.	Description	Std. Pk.	List Price	Code
8210	210 CFM, 6.5 Sones. 7" Round Vertical Discharge	1	\$176.68	HV

NuTone® — Side Discharge Fans

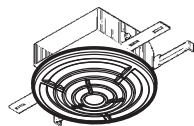

Model No.	Description	Std. Pk.	List Price	Code
8310	160 CFM, 5.0 Sones. 8" Round Side Discharge	1	\$216.56	HV

- Item too large to ship via UPS/FedEx. Item shipped common carrier at minimum rates.
- * All pricing reflects the individual item cost. You must order in multiples as indicated.
- ◆ UL listed for use over bathtubs and showers when connected to a GFCI protected branch circuit.

Broan® ULTRA™ Green Multi-Speed Series

We started with installation and worked back to build the ultimate bath fan. Unique telescoping mounting frame is ideal for both new construction and retrofit. No attic access needed! DC motor for efficiency. Multi-speed capability ideal for meeting ASHRAE 62.2, LEED, ENERGY STAR® for Homes and CA Title 24 — as well as local/spot ventilation needs. Powerful operation maintained over a wide range of real-world installations (CFM rating at 0.1" static pressure maintained through 0.25" static pressure). Fits in 2" x 8" ceiling construction. 10-1/2" L x 11-3/8" W x 7-5/8" H housing. 13" x 14" grille (fan) and 13" x 13-1/4" (fan/LED). All models have a 6" duct connector and the 50 CFM and 80 CFM models include a 6" to 4" reducer. All ULTRA 80 and 110 CFM fans can also be used with the MD6TU universal make-up air damper if 6" rigid duct is used. ULTRA non-sensing fans (not fan/lights) can also be used with the RDFU radiation damper. Now with QStream sound technology that features airflow-smoothing baffles to reduce noise caused by turbulence (50 and 80 CFM models only).

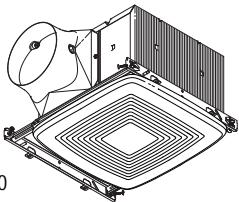

ZB80
ZB110

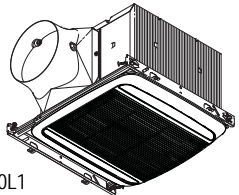

ZB80L1
ZB110L1

Model No.	Description	Std. Pk.	List Price	Code
Fans				
ZB80	◆ 30 CFM to 80 CFM, <0.3 Sones, ENERGY STAR Fan	1	\$321.30	HP
ZB110	◆ 30 CFM to 110 CFM, <0.3 Sones, ENERGY STAR Fan	1	\$351.18	HP
Fan/Light/Night Light				
ZB80L1	◆ 30 CFM to 80 CFM <0.3 Sones, ENERGY STAR Fan with Dual 18W Dimmable LEDs	1	\$440.62	HP
ZB110L1	◆ 30 CFM to 110 CFM <0.3 Sones, ENERGY STAR Fan with Dual 18W Dimmable LEDs	1	\$472.96	HP



All models are ENERGY STAR certified products.

Broan® ULTRA™ Green Single-Speed Series

We started with installation and worked back to build the ultimate bath fan. Unique telescoping mounting frame is ideal for both new construction and retrofit. No attic access needed! DC motor for efficiency. ASHRAE 62.2, LEED, ENERGY STAR® for Homes and CA Title 24 compliant. Powerful operation maintained over a wide range of real-world installations (CFM rating at 0.1" static pressure maintained through 0.25" static pressure). Fits in 2" x 8" ceiling construction. 10-1/2" L x 11-3/8" W x 7-5/8" H housing. 13" x 14" grille (fan) and 13" x 13-1/4" (fan/LED). All models have a 6" duct connector and the 50 CFM and 80 CFM models include a 6" to 4" reducer. All ULTRA 80 and 110 CFM fans can also be used with the MD6TU universal make-up air damper if 6" rigid duct is used. ULTRA non-sensing fans (not fan/lights) can also be used with the RDFU radiation damper. Now with QStream sound technology that features airflow-smoothing baffles to reduce noise caused by turbulence (50 and 80 CFM models only).

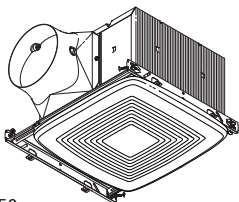

XB50
XB80
XB110

XB50L1
XB80L1
XB110L1

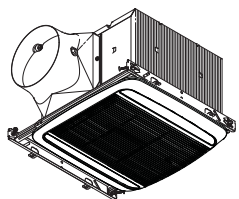

Model No.	Description	Std. Pk.	List Price	Code
Fans				
XB50	◆ 50 CFM, <0.3 Sones, ENERGY STAR Fan	1	\$275.40	HP
XB80	◆ 80 CFM, <0.3 Sones, ENERGY STAR Fan	1	\$292.38	HP
XB110	◆ 110 CFM, <0.3 Sones, ENERGY STAR Fan	1	\$313.56	HP
Fan/Light/Night Light				
XB50L1	◆ 50 CFM, <0.3 Sones, ENERGY STAR Fan with Dual 18W Dimmable LEDs	1	\$388.86	HP
XB80L1	◆ 80 CFM, <0.3 Sones, ENERGY STAR Fan with Dual 18W Dimmable LEDs	1	\$419.26	HP
XB110L1	◆ 110 CFM, <0.3 Sones, ENERGY STAR Fan with Dual 18W Dimmable LEDs	1	\$433.18	HP



All models are ENERGY STAR certified products.

- Item too large to ship via UPS/FedEx. Item shipped common carrier at minimum rates.
- * All pricing reflects the individual item cost. You must order in multiples as indicated.
- ◆ UL listed for use over bathtubs and showers when connected to a GFCI protected branch circuit.

Broan® ULTRA™ Green Multi-Speed Series — Sensing

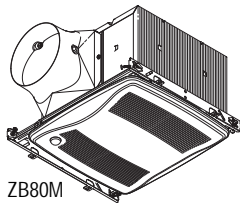

ZB80M
ZB110M

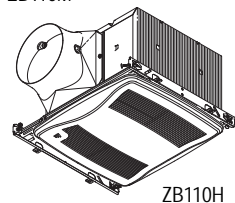

ZB110H

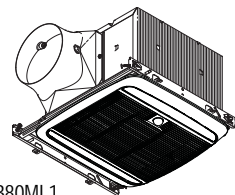

ZB80ML1
ZB110ML1

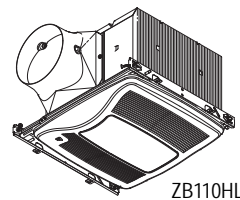

ZB110HL1

We started with installation and worked back to build the ultimate bath fan. Unique telescoping mounting frame is ideal for both new construction and retrofit. No attic access needed! DC motor for efficiency. Multi-speed capability ideal for meeting ASHRAE 62.2, LEED, ENERGY STAR® for Homes and CA Title 24 — as well as local/spot ventilation needs. Humidity or motion sensing triggers fan to ramp up from lower continuous ventilation level to maximum CFM. Powerful operation maintained over a wide range of real-world installations (CFM rating at 0.1" static pressure maintained through 0.25" static pressure). Fits in 2" x 8" ceiling construction. 10-1/2" L x 11-3/8" W x 7-5/8" H housing. 13" x 14" grille (fan) and 13" x 13-1/4" (fan/light/night light). All models have a 6" duct connector and the 80 CFM models include a 6" to 4" reducer. All ULTRA 80 and 110 CFM fans can also be used with the MD6TU universal make-up air damper if 6" rigid duct is used. ULTRA non-sensing fans (not fan/lights) can also be used with the RDFU radiation damper. Now with QStream sound technology that features airflow-smoothing baffles to reduce noise caused by turbulence (50 and 80 CFM models only).

Model No.	Description	Std. Pk.	List Price	Code
Fans				
ZB80M ◆	80 CFM, <0.3 Sones, ENERGY STAR Motion Sensing Fan	1	\$371.04	HP
ZB110H ◆	110 CFM, <0.3 Sones, ENERGY STAR Humidity Sensing Fan	1	\$466.78	HP
ZB110M ◆	110 CFM, <0.3 Sones, ENERGY STAR Motion Sensing Fan	1	\$399.08	HP
Fan/Light/Night Light				
ZB80ML1 ◆	80 CFM, <0.3 Sones, ENERGY STAR Motion Sensing Fan with 36W Fluorescent Light (2-18 watt GU24 bulbs included) and 4W Night Light (bulb not included)	1	\$497.52	HP
ZB110HL1 ◆	110 CFM, <0.3 Sones, ENERGY STAR Humidity Sensing Fan with Dual 18W Dimmable LEDs	1	\$593.52	HP
ZB110ML1 ◆	110 CFM, <0.3 Sones, ENERGY STAR Motion Sensing Fan with 36W Fluorescent Light (2-18 watt GU24 bulbs included) and 4W Night Light (bulb not included)	1	\$532.28	HP



All models are ENERGY STAR certified products.

Broan® ULTRA™ Green Single-Speed Series — Sensing

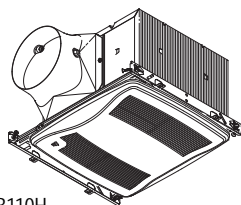

XB110H

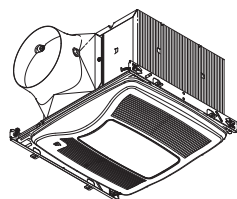

XB110HL1

We started with installation and worked back to build the ultimate bath fan. Unique telescoping mounting frame is ideal for both new construction and retrofit. No attic access needed! DC motor for efficiency. ASHRAE 62.2, LEED, ENERGY STAR® for Homes and CA Title 24 compliant. Humidity sensing models will automatically turn fan on when rapid rise in humidity is sensed. Powerful operation maintained over a wide range of real-world installations (CFM rating at 0.1" static pressure maintained through 0.25" static pressure). Fits in 2" x 8" ceiling construction. 10-1/2" L x 11-3/8" W x 7-5/8" H housing. 13" x 14" grille (fan) and 13" x 13-1/4" (fan/light/night light). All models have a 6" duct connector. All ULTRA 80 and 110 CFM fans can also be used with the MD6TU universal make-up air damper if 6" rigid duct is used. ULTRA non-sensing fans (not fan/lights) can also be used with the RDFU radiation damper. Now with QStream sound technology that features airflow-smoothing baffles to reduce noise caused by turbulence (50 and 80 CFM models only).

Model No.	Description	Std. Pk.	List Price	Code
Fan				
XB110H ◆	110 CFM, <0.3 Sones, ENERGY STAR Humidity Sensing Fan	1	\$420.66	HP
Fan/Light/Night Light				
XB110HL1 ◆	110 CFM, <0.3 Sones, ENERGY STAR Humidity Sensing Fan with Dual 18W Dimmable LEDs	1	\$544.58	HP



All models are ENERGY STAR certified products.

- ◆ Item too large to ship via UPS/FedEx. Item shipped common carrier at minimum rates.
- * All pricing reflects the individual item cost. You must order in multiples as indicated.
- ◆ UL listed for use over bathtubs and showers when connected to a GFCI protected branch circuit.

Ventilation Fans — ULTRA™

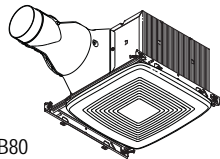

RB80
RB110

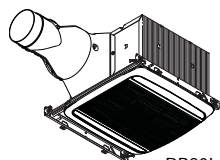

RB80L1
RB110L1

Broan® ULTRA™ Pro Fan and Fan/Light Series

The preferred install choice for professionals to deliver quiet performance *ULTRA*Quick™ installation, with no attic access required. QStream™ sound technology features airflow-smoothing baffles to reduce noise caused by turbulence and QFlow™ sound technology that removes the duct damper from the airstream to reduce static pressure. 4" duct for ideal retrofit installation and ENERGY STAR® qualified. 10-1/2" x 11-3/8" x 7-5/8" housing fits 2" x 8" ceiling construction. UL Listed for use over bathtubs and showers when connected to a GFCI protected branch circuit.

Model No.	Description	Std. Pk.	List Price	Code
Fans				
RB80	80 CFM, <0.3 Sones, ENERGY STAR Fan	1	\$272.54	HP
RB110	110 CFM, 0.6 Sones, ENERGY STAR Fan	1	\$302.30	HP
Fan/Light				
RB80L1	80 CFM, <0.3 Sones, ENERGY STAR Fan with Dual 18W Dimmable LEDs	1	\$398.32	HP
RB110L1	110 CFM, <0.3 Sones, ENERGY STAR Fan with Dual 18W Dimmable LEDs	1	\$424.80	HP



All models are ENERGY STAR certified products.

Ventilation Fans — QT Series™

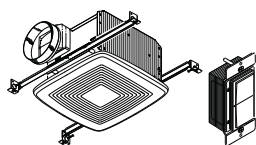

SSQTXE080
SSQTXE110

Broan SmartSense® Intelligent Ventilation System

The intelligent fan control system creates an integrated residential exhaust ventilation system using Broan's industry leading ventilation control technology and award winning QTXE fans. The Broan SmartSense system uses Broan's Link-Logic™ control technology powered by INSTEON™, a powerful communication technology to monitor everyday manual fan usage throughout the home. Broan SmartSense calculates additional ventilation required by Green Building and ASHRAE Standard 62 related requirements and automatically controls installed fans to achieve proper ventilation. SSQTXE080 and SSQTXE110 fans can provide a single fan solution for small apartments or mix and matched for a customized, integrated ventilation system.

Model No.	Description	Std. Pk.	List Price	Code
SSQTXE080	80 CFM SmartSense Fan with Control	1	\$298.54	HV
SSQTXE110	110 CFM SmartSense Fan with Control	1	\$331.60	HV

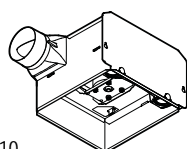

SPK110

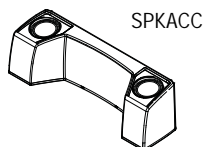

SPKACC

Broan® Ventilation Fan with Sensonic™ Speakers and Speaker Kit

Unlike wireless speakers that require counter space, Sensonic speakers with Bluetooth® wireless technology fill your room with rich sound from above. From hard rock to news talk, play any audio through the dual high-fidelity speakers and enjoy entertainment and privacy at the touch of a button. It's brilliant audio performance concealed behind the fan grille.

Model No.	Description	Std. Pk.	List Price	Code
SPK110	Sensonic Speaker Fan; 110 CFM, 1.0 Sones	1	\$410.64	HV
SPKACC	Sensonic Speaker Accessory	1	\$189.26	AC

- Item too large to ship via UPS/FedEx. Item shipped common carrier at minimum rates.
- * All pricing reflects the individual item cost. You must order in multiples as indicated.
- ◆ UL listed for use over bathtubs and showers when connected to a GFCI protected branch circuit.

Ventilation Fans — QT Series™

Broan® QT Series™ (QTXE Models)

The industry's quietest, most powerful and stylish fans with a 3 year warranty. 6" ducting for superior performance and ENERGY STAR certified. Includes hanger bar system for fast and flexible installations for all types of construction. Fits in 2" x 8" ceiling construction. 10-1/2" x 11-3/8" x 7-5/8" high housing. 14" x 15" grille (QTXE fans) and 13-3/8" x 14-1/4" grille (QTXE fan/lights).

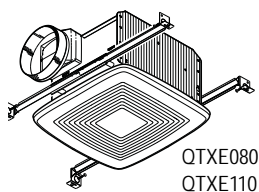

QTXE080
QTXE110

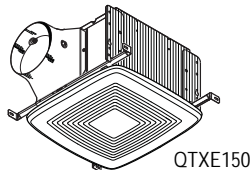

QTXE150

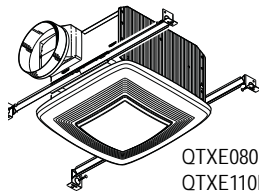

QTXE080FLT
QTXE110FLT

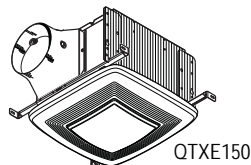

QTXE150FLT

Model No.	Description	Std. Pk.	List Price	Code
Fans				
QTXE080 ◆	80 CFM, 0.3 Sones, ENERGY STAR Fan	1	\$262.78	HV
QTXE110 ◆	110 CFM, 0.7 Sones, ENERGY STAR Fan	1	\$297.34	HV
QTXE150 ◆	150 CFM, 1.4 Sones, ENERGY STAR Fan	1	\$356.16	HV
Fan/Light/Night Light				
QTXE080FLT ◆	80 CFM, 0.3 Sones, ENERGY STAR Fan with 36W Fluorescent Light (2-18 watt GU24 bulbs included) and 4W Night Light (bulb not included)	1	\$387.24	HV
QTXE110FLT ◆	110 CFM, 0.7 Sones, ENERGY STAR Fan with 36W Fluorescent Light (2-18 watt GU24 bulbs included) and 4W Night Light (bulb not included)	1	\$428.70	HV
QTXE150FLT ◆	150 CFM, 1.4 Sones, ENERGY STAR Fan with 36W Fluorescent Light (2-18 watt GU24 bulbs included) and 4W Night Light (bulb not included)	1	\$501.36	HV



All models are ENERGY STAR certified products.

Broan® QT Series™ Humidity Sensing Fan and Fan/Light

Humidity sensing integrated in a ventilation fan is another industry exclusive! Featuring Sensaire® technology and models that are ENERGY STAR® certified, this Ultra Silent™ Humidity Sensing fan is the most effective way to control excess humidity and moisture, even in the most frequently used bathrooms. Homeowners and property managers will appreciate the fact that Broan's humidity sensing fan is automatic — once there is a rapid rise in humidity, the fan will automatically turn on to exhaust excess moisture and turn off once the job is done. The industry's quietest, most powerful and stylish fan with a 3 year warranty. 6" ducting for superior performance. Fits 2" x 8" ceiling construction. 10-1/2" x 11-3/8" x 7-5/8" high housing. 13" x 13-3/4" grille.

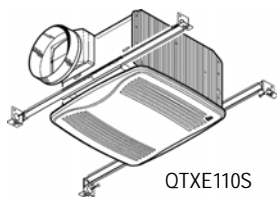

QTXE110S

Model No.	Description	Std. Pk.	List Price	Code
Fan				
QTXE110S ◆	110 CFM, 0.7 Sones, ENERGY STAR Humidity Sensing Fan	1	\$416.64	HV

Broan® InVent™ Series Sensing Ventilation Fans and Fan/Lights

Introducing the InVent Series humidity sensing fan and fan/light. Building on the innovative features of the InVent Series, the humidity sensing product line will utilize our patented Sensaire™ sense-on-rise technology. The sensor has a user adjustable sensitivity control that simultaneously adjusts the humidity rate-of-rise sensitivity and the humidity set point. In addition to the flexible installation, this humidity sensing product line features LED lighting.

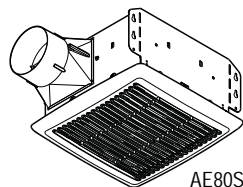

AE80S
AE110S

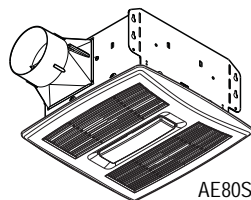

AE80SL
AE110SL

Model No.	Description	Std. Pk.	List Price	Code
Fans				
AE80S	80 CFM, 0.8 Sones, ENERGY STAR Sensing Fan	1	\$339.56	HM
AE110S	110 CFM, 1.0 Sones, ENERGY STAR Sensing Fan	1	\$368.14	HM
Fan/Light				
AE80SL	80 CFM, 0.8 Sones, ENERGY STAR Sensing Fan with LED Light	1	\$446.26	HM
AE110SL	110 CFM, 1.0 Sones, ENERGY STAR Sensing Fan with LED Light	1	\$508.88	HM

- Item too large to ship via UPS/FedEx. Item shipped common carrier at minimum rates.
- * All pricing reflects the individual item cost. You must order in multiples as indicated.
- ◆ UL listed for use over bathtubs and showers when connected to a GFCI protected branch circuit.

Ventilation Fans — InVent™ Series

Broan® InVent™ Series Ventilation Fans

New, versatile housing platform that marks a revolution of our mid-range ventilation fans and allows for easy installation in both new construction and retrofit applications. 10" x 9-1/4" x 5-3/4" housing features foldable mounting ears for easy, room-side replacement. 4" duct connector mounts from the inside of the housing and features a new damper technology, improving air tightness scores.

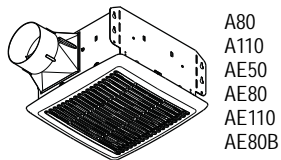

A80
A110
AE50
AE80
AE110
AE80B

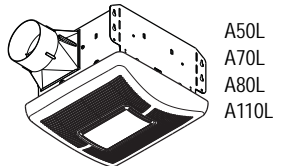

A50L
A70L
A80L
A110L

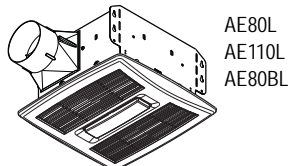

AE80L
AE110L
AE80BL

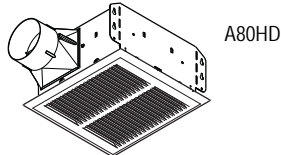

A80HD

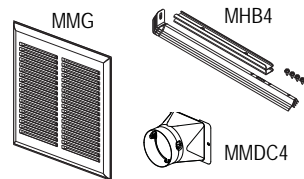

MMG

MHB4



MMDC4

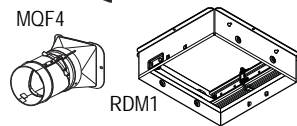

MQF4

RDM1

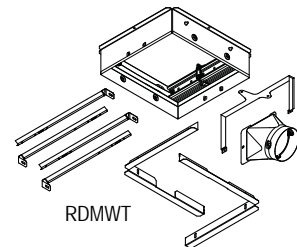

RDMWT

Model No.		Description	Std. Pk.	List Price	Code
Ventilation Fans					
A80	Ω	80 CFM, 2.0 Sones	1	\$156.00	HM
A110	Ω	110 CFM, 3.0 Sones	1	\$173.34	HM
A80HD	Ω	80 CFM, 2.0 Sones, Metal Grille	1	\$201.08	HM
AE50	Ω	50 CFM, 0.5 Sones, ENERGY STAR Fan	1	\$173.34	HM
AE80	Ω	80 CFM, 0.8 Sones, ENERGY STAR Fan	1	\$249.60	HM
AE110	Ω	110 CFM, 1.0 Sones, ENERGY STAR Fan	1	\$277.34	HM
AE80B	Ω	80 CFM, 1.5 Sones, ENERGY STAR Fan	1	\$121.34	HM
Ventilation Fan/Lights					
A50L		50 CFM, 1.5 Sones	1	\$150.80	HM
A70L		70 CFM, 2.0 Sones	1	\$152.54	HM
A80L		80 CFM, 1.0 Sones	1	\$364.00	HM
A110L		110 CFM, 1.3 Sones	1	\$398.68	HM
AE80BL	Ω	LED Light, 80 CFM, 1.5 Sones, ENERGY STAR Fan/Light	1	\$225.32	HM
AE80L	Ω	LED Light, 80 CFM, 0.8 Sones, ENERGY STAR Fan/Light	1	\$416.00	HM
AE110L	Ω	LED Light, 110 CFM, 1.0 Sones, ENERGY STAR Fan/Light	1	\$450.68	HM
Accessories					
MHB4		Hanger Bars	1	\$20.80	AC
MMDC4	■	Metal Duct Connector	1	\$26.00	AC
MMG		Metal Grille, White	1	\$45.08	AC
MQF4		QFlow Duct Connector	1	\$20.80	AC
RDM1		Radiation Damper	1	\$173.34	HM
RDMWT		Radiation Damper for UL wood truss assembly listings L521, L528, L546, L558, L562, L574, L576, L581, L583, L585, P522, P533, P538, P545 and P547.	1	\$173.34	HM

Ω Works with Model RDM1 and RDMWT radiation damper. Sensing models work with RDMWT only.



Select models are ENERGY STAR certified products— see product description.

■ Limited quantities available.

- Item too large to ship via UPS/FedEx. Item shipped common carrier at minimum rates.
- * All pricing reflects the individual item cost. You must order in multiples as indicated.
- ◆ UL listed for use over bathtubs and showers when connected to a GFCI protected branch circuit.

Broan® Recessed Fan/Lights

Recessed lights are popular lighting solutions. But Broan took it a step further by incorporating powerful ventilation in the same design. Our new fan/lights disappear into the ceiling with other recessed lights, so they are practical decorating solutions for any room in the house. In the bath they control humidity, and in a utility room, kitchen or high-traffic family room they keep the air fresh and comfortable. 12-3/4" x 8-1/4" x 6-3/4" high housing. 7-3/8" round trim. Damper/duct connector fits 4" duct. Type IC. Fits in 2" x 8" ceiling construction.

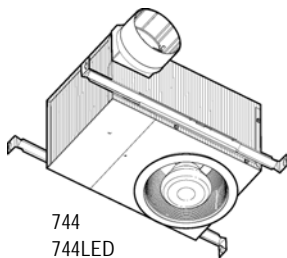

Model No.	Description	Std. Pk.	List Price	Code
744	◆ Recessed Fan/Light, 70 CFM, 1.5 Sones. 6" white trim. Use 75W max R30 or BR30 bulb for standard applications.	1	\$178.84	NF
744LED	◆ Recessed Fan/LED Light, ENERGY STAR, 70 CFM, 1.5 Sones. 6" white trim. Uses 10W BR30 LED bulb (bulb included).	1	\$320.30	NF



Select models are ENERGY STAR certified products — see product description.

Broan® Ventilation Fan with Soft Surround™ LED Lighting Technology

Powerful, uniquely designed ventilation fan with LED light removes stale air and moisture from bathrooms. HVI certified at 110 CFM, 1.5 Sones. 9-1/4" x 10" x 5-3/4" housing. Damper/duct connector fits 4" round duct. Energy efficient 9 watt LED light is integrated into the unique, low profile grille. The perimeter lighting provides outstanding room coverage and the lens has quality diffusion that eliminates hot spots for a soft yet bright glow. Up to 25,000 hour life means the light may never have to be replaced.

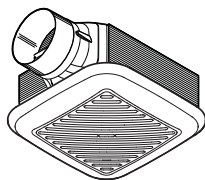

Model No.	Description	Std. Pk.	List Price	Code
791LEDM	ENERGY STAR Ventilation Fan with LED lighting, 110 CFM, 1.5 Sones. Uses 9W integrated LED module (included).	1	\$262.46	HM



ENERGY STAR certified products.

Broan® Decorative Fan/Light

Styling that takes decorative light/fans to the next level. Designs are attractive as lights alone and make no concessions to ventilation function. Styles cover a range of decorating tastes from antique to contemporary. All accept two 60-watt max incandescent bulbs (bulbs not included). Corrosion-resistant finishes. Plug-in light fixture assemblies. Plug-in permanently lubricated motors. 8" x 8-1/4" x 5-3/4" high housing. 4" round duct connectors. Type IC. Fits in 2" x 6" ceiling construction.



Model No.	Description	Std. Pk.	List Price	Code
741SN	Decorative Satin Nickel Fan/Light with frosted glass, 70 CFM, 3.5 Sones. 13-3/8" diameter base.	1	\$180.34	HV
754RB	Decorative Oil-Rubbed Bronze Fan/Light, white alabaster glass, 70 CFM, 3.5 Sones. 13-3/8" diameter base.	1	\$183.24	HV
761BN	Decorative Brushed Nickel Fan/Light, with opal glass, 80 CFM, 2.5 Sones. 13-1/4" diameter base.	1	\$196.98	HV
761RB	Decorative Oil-Rubbed Bronze Fan/Light, with ivory alabaster glass, 80 CFM, 2.5 Sones. 13-1/4" diameter base.	1	\$196.98	HV
761WHA	Decorative White Fan/Light, with white alabaster glass, 80 CFM, 2.5 Sones. 13-1/4" diameter base.	1	\$196.98	HV
MCB2	Mounting Channel/Brackets for single packs (2 channels, 4 brackets).	1	\$15.54	AC

- Item too large to ship via UPS/FedEx. Item shipped common carrier at minimum rates.
- * All pricing reflects the individual item cost. You must order in multiples as indicated.
- ◆ UL listed for use over bathtubs and showers when connected to a GFCI protected branch circuit.

Broan® LoProfile™ Ventilation Fan

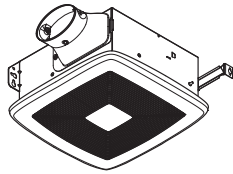

The new Broan LoProfile™ fan is our latest solution for installations where conventional ventilation simply won't fit. Where multi-family applications require it, the LoProfile™ fan is narrow enough to be installed in a wall between 2 x 4 studs. When plumbing or electrical obstructions are found behind the drywall in ceiling remodel applications our LoProfile™ fan can still fit without having to move anything. And that means most any room with space constraints can have powerful, quiet and efficient ventilation.

Model No.	Description	Std. Pk.	List Price	Code
LP80	80 CFM, 1.0 Sones, ENERGY STAR Fan	1	\$103.50	HV
LP110	110 CFM, 1.5 Sones, ENERGY STAR Fan	1	\$107.26	HV



ENERGY STAR certified products.

Broan® Heavy Duty™ Fan/Light

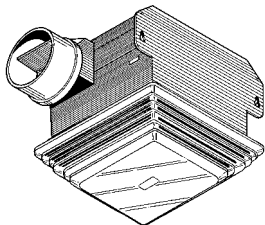

Heavy Duty™ fan/light was designed for continuous operation — perfect for tough, light-commercial applications. Motor has heavy duty, long-life bearings, tamper proof construction, and is totally enclosed for added protection against dirt and dust. Centrifugal blower wheel provides quiet, efficient ventilation. Convenient mounting ears speed installation. Fan/light unit has white molded 11-1/8" x 10-5/8" polymeric grille and shatter-resistant light lens. 8" x 8-1/4" x 5-3/4" high housing. Damper/duct connector fits 4" round duct. Type IC (Insulation Contact). Fits in 2" x 6" ceiling construction.

Model No.	Description	Std. Pk.	List Price	Code
HD80L	♦ Heavy Duty Fan/Light, 80 CFM, 2.5 Sones. 100W max Incandescent Light (bulb not included). Type IC.	1	\$160.86	HV
MCB2	Mounting Channel/Brackets for single packs (2 channels, 4 brackets).	1	\$15.54	AC

Broan® Radiation Damper Project Packs

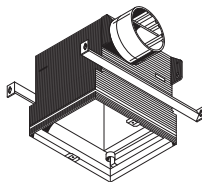

RDH

Model No.	Description	Std. Pk.	List Price	Code
RDH	Housing with radiation damper attached	4 *	\$144.32	HV
80RDF	80 CFM motor with metal grille finish pack	4 *	\$113.60	HV
110RDF	110 CFM motor with metal grille finish pack	4 *	\$119.56	HV
HD50RDF	Heavy duty 50 CFM motor with metal grille finish pack	4 *	\$125.72	HV

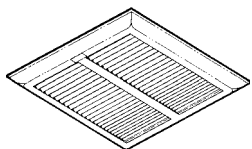

Broan® Metal Grille Kit — Selected Ventilation Fans

Everything you need to furnish a metal grille for most standard Broan exhaust fans. Spring-mounted hardware included.

Model No.	Description	Std. Pk.	List Price	Code
S97011308	White Metal Grille Kit, fits Models 670, 671, 688 & 689	1	\$47.88	PT

Broan® Fan/Lights

9" x 9" x 6" housing. Damper/duct connector fits 4" round duct. Bright 100-watt max light capacity. All models are Type IC. Bulbs not included. Fits in 2" x 6" ceiling construction.

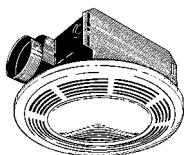

750
751

Model No.	Description	Std. Pk.	List Price	Code
750	♦ Fan/Light/Night Light, 100 CFM, 3.5 Sones, round white grille with glass lens	1	\$253.84	HV
751	♦ Fan/Light, 100 CFM, 3.5 Sones, round white grille with glass lens	1	\$228.84	HV
MCB2	Mounting Channel/Brackets for single packs (2 channels, 4 brackets).	1	\$15.54	AC

- ♦ Item too large to ship via UPS/FedEx. Item shipped common carrier at minimum rates.
- * All pricing reflects the individual item cost. You must order in multiples as indicated.
- ♦ UL listed for use over bathtubs and showers when connected to a GFCI protected branch circuit.

Ventilation Fans

Broan® Economy Fans

Molded plastic impeller, two-pole motor, 7-1/4" x 7-1/2" x 3-5/8" high galvanized steel housing for ceiling or wall installation. Spring mounted 9-1/4" x 9" plastic grille. Damper/duct connector fits 3" round duct. Snap-in motor plate requires no tools for installation or removal. Fits 2" x 4" ceiling or wall construction.

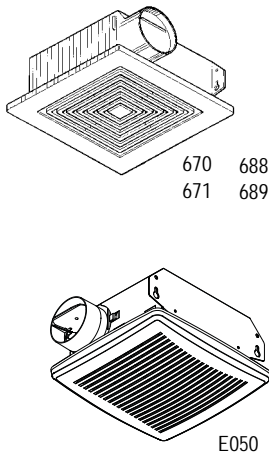

Model No.	Description	Std. Pk.	List Price	Code
Fans				
670	◆ Ventilation Fan, 50 CFM, 3.5 Sones	1	\$67.62	LV
671	◆ Ventilation Fan, 70 CFM, 6.0 Sones	1	\$61.84	LV
688	◆ Ventilation Fan, 50 CFM, 4.0 Sones	1	\$46.98	LV
689	◆ Ventilation Fan, 60 CFM, 5.5 Sones	1	\$58.52	LV
E050	50 CFM, 2.5 Sone Economy Fan	1	\$36.94	LV
E070	70 CFM, 4.0 Sone Economy Fan	1	\$49.50	LV
Finish Packs				
E0F50	50 CFM, 2.5 Sone Finish Pack	6 *	\$28.36	LV
E0F70	70 CFM, 4.0 Sone Finish Pack	6 *	\$40.90	LV

All models available in project packs, see Page 70.

Broan® Economy Fan/Light

Compact unit provides ventilator and 100-watt light capacity in one unit (bulb not included). Molded 11-1/8" x 10-5/8" plastic grille and shatter-resistant lens. 8" x 8-1/4" x 5-3/4" high housing. Fits 4" round duct. Fits in 2" x 6" ceiling construction.

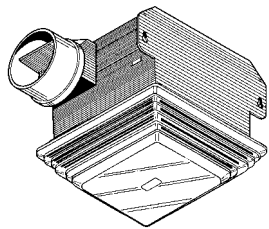

Model No.	Description	Std. Pk.	List Price	Code
678	◆ 50 CFM, 2.5 Sones Fan/Light. Type IC.	1	\$101.20	LV
MCB2	Mounting Channel/Brackets for single packs (2 channels, 4 brackets).	1	\$15.54	AC

All models available in project packs, see Page 70.

Broan® Bath Fan Upgrade Kit

The patented economy fan Bath Fan Upgrade Kit improves performance, reduces the sound level, and upgrades the appearance of your economy fan in 10 minutes. Provide easy upgrade for economy fan without replacing the entire housing, rewiring and reconnecting the duct. Helps ensure tenant/homeowner is using the fan when needed most. Reduces sound up to 50%, improves air movement up to 20% and helps control humidity that causes mold and mildew. Kit includes quiet fan motor, grille, wrench and two motor plates.

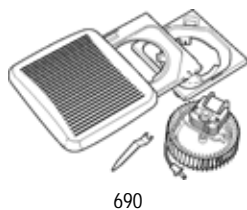

Model No.	Description	Std. Pk.	List Price	Code
690	60 CFM, 3.0 Sones, Economy Upgrade Kit	1	\$62.12	UK

The 690 Upgrade Kit replaces the models below.

Model No.	Housing Dimension
Broan: 670, 671, 688 & 689	7-1/2" x 7-1/4" only 8" x 8-1/4" are not compatible.
Nautilus: N671 & N688	
NuTone: 693, 695 & 696N	7-1/2" x 7-1/4" or 8" x 7-1/4"

Broan® Duct-Free Fan

No ductwork necessary! Ideal for powder rooms and closets. Type IC (Insulation Contact). Fits in 2" x 4" construction.

Model No.	Description	Std. Pk.	List Price	Code
682	Duct-free Fan with plastic grille. Includes long lasting, easy to replace activated charcoal filter. Easy snap-in mounting.	1	\$70.32	LV

- Item too large to ship via UPS/FedEx. Item shipped common carrier at minimum rates.
- * All pricing reflects the individual item cost. You must order in multiples as indicated.
- ◆ UL listed for use over bathtubs and showers when connected to a GFCI protected branch circuit.

Ventilation Fans — Project Packs

Broan® InVent™ Series Project Packs (Housing and Finish Packs)

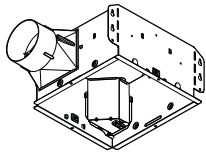

A000HF

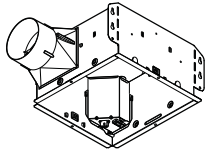

A000HL

Model No.	Description	Std. Pk.	List Price	Code
Housing Packs				
A000HF	Ventilation Fan/Light Housing Pack	4 *	\$24.28	HM
A000HL	Ventilation Fan Housing Pack	4 *	\$24.28	HM
Finish Packs				
A70LF	70 CFM, 2.0 Sones, Finish Pack	4 *	\$128.28	HM
A80F	Ω 80 CFM, 2.0 Sones, Finish Pack	4 *	\$131.74	HM
A80HDF	Ω 80 CFM, 2.0 Sones, Metal Grille, Finish Pack	4 *	\$176.80	HM
A110F	Ω 110 CFM, 3.0 Sones, Finish Pack	4 *	\$149.08	HM
AE50F	Ω 50 CFM, 0.5 Sones, ENERGY STAR Finish Pack	4 *	\$149.08	HM
AE80BF	Ω 80 CFM, 1.5 Sones, ENERGY STAR Finish Pack	4 *	\$97.08	HM
AE80BLF	Ω LED light, 80 CFM, 1.5 Sones, ENERGY STAR Finish Pack	4 *	\$201.06	HM
AE80F	Ω 80 CFM, 0.8 Sones, ENERGY STAR Finish Pack	4 *	\$225.34	HM
AE80LF	Ω LED light, 80 CFM, 0.8 Sones, ENERGY STAR Finish Pack	4 *	\$391.74	HM
AE110F	Ω 110 CFM, 1.3 Sones, ENERGY STAR Finish Pack	4 *	\$253.08	HM
AE110LF	Ω LED light, 110 CFM, 1.3 Sones, ENERGY STAR Finish Pack	4 *	\$351.36	HM

Ω Works with Model RDM1 and RDMWT radiation damper.



Select models are ENERGY STAR certified products — see product description.

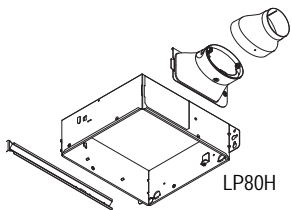

LP80H

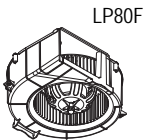

LP80F

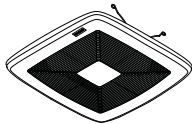

Broan® LoProfile™ Project Packs

The new Broan LoProfile™ fan is our latest solution for installations where conventional ventilation simply won't fit. Where multi-family applications require it, the LoProfile™ fan is narrow enough to be installed in a wall between 2 x 4 studs. When plumbing or electrical obstructions are found behind the drywall in ceiling remodel applications, our LoProfile™ fan can still fit without having to move anything. And that means most any room with space constraints can have powerful, quiet and efficient ventilation. Project Packs offer availability to buy housings for rough-in and motor/blower assemblies and grille later for finishing.

Model No.	Description	Std. Pk.	List Price	Code
LP80F	ENERGY STAR Finish Pack. Motor and Grille Assembly. 80 CFM, 1.0 Sones.	4 *	\$81.00	HV
LP80H	Housing Pack for LP80	4 *	\$25.84	HV
LP110F	ENERGY STAR Finish Pack. Motor and Grille Assembly. 110 CFM, 1.5 Sones.	4 *	\$83.86	HV
LP110H	LoProfile Housing Pack for LP110	4 *	\$28.68	HV



Select models are ENERGY STAR certified products — see product description.

- Item too large to ship via UPS/FedEx. Item shipped common carrier at minimum rates.
- * All pricing reflects the individual item cost. You must order in multiples as indicated.
- ◆ UL listed for use over bathtubs and showers when connected to a GFCI protected branch circuit.

Broan® Radiation Damper Accessory Kit

Model No.	Description	Std. Pk.	List Price	Code
RDFQF	Radiation damper accessory that works with Models QTRE080, QTRE080C2S, QTRE080R, QTRE110, QTXE050, QTXE080, QTXE110, SSQTXE110, SSQTXE80, QTR110F, QTRE110F, QTR080F and QTRE080F.	1	\$126.08	HV
RDFQL	Radiation damper accessory that works with Models QTRE080FLT, QTRE110FLT, QTXE110FLT, QTXE080FLT, QTXE110FLT, QTRE110FLFT and QTRE080FLFT. Also works with Models QTXE110S and QTXE110SFLT when used with RDJUMPO accessory.	1	\$126.08	HV
RDFU	Radiation damper accessory that works with Models QTXE150, QTXE150FLT, RB80, RB110, XB50, XB80, XB110, ZB80 and ZB110. Also works with Models RB80L, RB80L1, RB110L, RB110L1, XB110HL, ZB110HL, ZB80ML, ZB110ML, XB50L, XB50L1, XB80L1, XB110L1, XB110HL1, ZB80L1, ZB80ML1, ZB110L1, ZB110HL1, ZB110ML1, XB80L, XB110L, ZB80L, ZB110L, XB110H, ZB110H, ZB80M and ZB110M when used with RDJUMPU accessory.	1	\$126.08	HP
RDFUWT	Radiation damper accessory that works with Models QTXE150, QTXE150FLT, RB80, RB110, XB50, XB80, XB110, ZB80 and ZB110. Also works with Models RB80L, RB110L, XB110HL, ZB110HL, ZB80ML, ZB110ML, XB50L, XB50L1, XB80L, XB80L1, XB110L, ZB80L, ZB110L, XB110H, ZB110H, ZB80M, ZB110M, XB110L1, XB110HL1, ZB80L1, ZB80ML1, ZB110L1, ZB110HL1 and ZB110ML1 when used with RDJUMPU accessory. For UL wood truss assembly listings L521, L528, L546, L558, L562, L574, L576, L581, L583, L585, P522, P533, P538, P545 and P547. Available May, 2017.	1	\$126.08	HP
RDJ1	Radiation damper accessory with metal grille and metal duct connector (no housing). Works with 770, 784, 676, 684, HD50 and HD80.	1	\$147.02	HV
RDF1	Radiation damper. Works with ULTRA® Series non-sensing fans (not fan/lights) and LP80.	1	\$126.08	HP
Accessories				
RDJUMPO	Wiring jumper kit required for use with RDFQL when used with Models QTXE110S and QTXE110SFLT.	1	\$8.78	AC
RDJUMPU	Wiring jumper kit required for use with RDFU when used with Models XB110HL, ZB110HL, ZB80ML, ZB110ML, XB50L, XB80L, XB110L, ZB80L, ZB110L, XB110H, ZB110H, ZB80M and ZB110M.	1	\$17.58	AC
RDJUMPU1	Radiation damper jumper kit Ultra LED. Wiring jumper kit required for use with RDFU when used with Models XB110HL1, ZB110HL1, ZB80ML1, ZB110ML1, XB50L1, XB80L1, XB110L1, ZB80L1 and ZB110L1.	1	\$17.58	AC

Broan® Fan and Combination Unit Project Packs

Broan's project packs offer a variety of housings packed and sold separately from motor assembly and grille. You can buy housings for rough-in ... buy assemblies and grilles later for finishing. Type IC.

Fan/Light Project Packs — Fits 2" x 6" Ceiling Construction

Model No.	Description	Std. Pk.	List Price	Code
2677H	Housing Pack for 2678F, 2679F, 2680F, FL2679F, FL2679FT, FL2680F and FL2680FT. Type IC. Mounting ears.	4 *	\$17.06	LV
3677H	Housing Pack. Same as 2677H, except includes built-in slide channels and mounting brackets.	4 *	\$21.88	LV
2678F	◆ Finish Pack. Motor, Reflector and Grille Assembly. 50 CFM, 2.5 Sones, 100W light. Uses 2677H or 3677H housing pack.	4 *	\$84.14	LV

- Item too large to ship via UPS/FedEx. Item shipped common carrier at minimum rates.
- * All pricing reflects the individual item cost. You must order in multiples as indicated.
- ◆ UL listed for use over bathtubs and showers when connected to a GFCI protected branch circuit.

Broan Economy Fan Project Packs — Fits 2" x 4" Ceiling or Wall Construction

Model No.	Description	Std. Pk.	List Price	Code
1667H	Housing Pack for 1670F, 1671F, 1688F and 1689F (damper/plastic duct connector included)	6 *	\$10.38	LV
1667HMTL	Housing Pack for 1670F, 1671F, 1688F and 1689F (damper/metal duct connector included)	6 *	\$24.60	LV
1670F	◆ Finish Pack. Motor Assembly and Grille. 50 CFM, 3.5 Sones.	6 *	\$57.24	LV
1671F	◆ Finish Pack. Motor Assembly and Grille. 70 CFM, 6.0 Sones.	6 *	\$51.46	LV
1688F	◆ Finish Pack. Motor Assembly and Grille. 50 CFM, 4.0 Sones.	6 *	\$36.60	LV
1689F	◆ Finish Pack. Motor Assembly and Grille, 60 CFM, 5.5 Sones	6 *	\$48.14	LV

Combination Unit Project Packs — Fits 2" x 6" Ceiling Construction

Model No.	Description	Std. Pk.	List Price	Code
654H	Housing Pack for 655F, 656F, 657F, 658F and 659F (damper/duct connector included). Type IC.	4 *	\$27.72	LV
655F	Finish Pack. Heater/Fan/Light Assembly and Grille. 70 CFM, 4.0 Sones, 100W light, 1300W heater. Uses 654H housing pack.	1	\$199.44	LV
656F	Finish Pack. Heater/Light Assembly and Grille. 100W light, 1300W heater. Uses 654H housing pack.	1	\$170.38	LV
657F	◆ Finish Pack. Fan/Light Assembly and Grille. 70 CFM, 4.0 Sones, 100W light. Uses 654H housing pack.	1	\$122.04	LV
658F	Finish Pack. Heater/Fan Assembly and Grille. 70 CFM, 4.0 Sones, 1300W heater. Uses 654H housing pack.	1	\$191.98	LV
659F	Finish Pack. Heater/Fan/Light Assembly and Grille. 50 CFM, 2.5 Sones, 100W light, 1300W heater. Uses 654H housing pack.	1	\$196.26	LV

- Item too large to ship via UPS/FedEx. Item shipped common carrier at minimum rates.
- * All pricing reflects the individual item cost. You must order in multiples as indicated.
- ◆ UL listed for use over bathtubs and showers when connected to a GFCI protected branch circuit.

Ventilation Fans — Heater Combinations

Broan® QT Series™ Heater/Fan/Light

Powerful heating, lighting and ventilation available at the touch of a switch. Quiet, high output 1500 watt heater with exclusive PowerHeat™ design. Requires a dedicated 20 amp circuit. 3 year warranty. 6" ducting for superior performance. 17-5/8" x 11-3/8" x 7-5/8" high housing with hanger bar system. 20" x 15" grille. Fits in 2" x 8" ceiling construction.

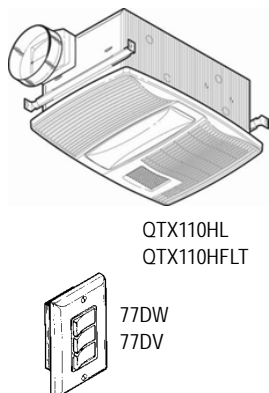

Model No.	Description	Std. Pk.	List Price	Code
QTX110HL	110 CFM, 0.9 Sones, Fan with 1500W heater, 2-60W max incandescent light and 7W night light (bulbs not included). Recommend 77 Series switch.	1	\$570.46	HV
QTX110HFLT	110 CFM, 0.9 Sones, Fan with 1500W heater, 2-18W high efficiency, GU24 based fluorescent light (bulbs included) and 7W night light (bulb included). Recommend 77 Series switch.	1	\$634.76	HV
77DW / 77DV	Three-Switch Control for use with sensing Fan/Lights (top switch provides three settings for sensor On/Auto/Off), remaining switches control light, night light and QT Heater/Fan/Light/Night Light (top switch controls light and night light, remaining switches control fan and heater).	1	\$46.38	AC

Broan® Directionally-Adjustable Heater with Fan and Light

These heaters feature 1500 watts of powerful, directionally-adjustable heat along with 100 CFM of ventilation at only 2.0 sones. They have 4" ducting and fit in 2" x 6" ceiling construction. Attractive grilles are 17-1/2" x 11-1/2" covering a 16" x 10-1/4" x 5-7/8" housing.

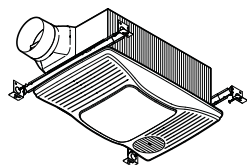

Model No.	Description	Std. Pk.	List Price	Code
100HL	Features 100W max incandescent lighting (bulb not included)	1	\$316.86	LV
100HFL	Features 27W fluorescent lighting (bulb included)	1	\$381.18	LV

Broan® Heater Combinations

Model 655 Heater/Fan/Light (featured) has a 1300-watt fan-forced heater and 70 CFM, 3.5 Sones ventilator, plus 100-watt light capacity in one compact unit (bulb not included). Two separate motors for heater and ventilator. Attractive 16-3/4" x 10-5/8" molded plastic grille and shatter-resistant lens. Built-in damper/duct connector fits 4" round duct. 14-1/4" x 8-1/4" x 5-3/4" high housing. Bulbs not included with any combination unit. All units are Type IC (Insulation Contact). Fits in 2" x 6" ceiling construction.

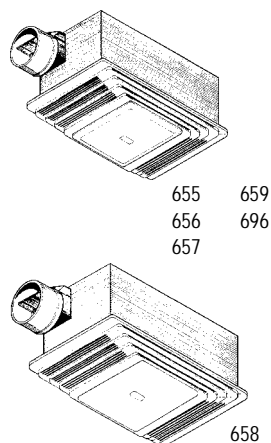

Model No.	Description	Std. Pk.	List Price	Code
655	Heater/Fan/Light, 70 CFM, 4.0 Sones	1	\$227.16	LV
656	Heater/Light; same as Model 655 but does not include fan	1	\$198.08	LV
657	◆ Fan/Light; same as Model 655 but does not include heater	1	\$149.76	LV
658	Heater/Fan; same as Model 655 but does not include light	1	\$219.72	LV
659	Heater/Fan/Light; same as Model 655 except 50 CFM, 2.5 Sones	1	\$224.00	LV
696	Fan/Light; same as Model 657 except 100 CFM, 4.5 Sones. Includes acoustic insulation.	1	\$205.76	LV

Select models available in project packs, see Page 70.

- Item too large to ship via UPS/FedEx. Item shipped common carrier at minimum rates.
- * All pricing reflects the individual item cost. You must order in multiples as indicated.
- ◆ UL listed for use over bathtubs and showers when connected to a GFCI protected branch circuit.

Ventilation Fans — Heater Combinations

Broan® Bulb Heaters and Heater/Fans

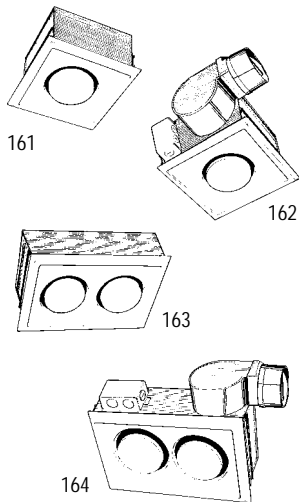

Produce instant warmth with standard BR40/R40 size 250-watt infrared bulbs (not included). Attractive molded plastic grilles. Damper/duct connector fits 4" round duct (Models 162 and 164). Models 161 and 162 grilles measure 10-1/4" x 10-1/4". Models 163 and 164 grilles measure 10-1/4" x 15-5/8". Housing sizes are noted below. Includes adjustable hanger bar system that spans up to 24". Fits 2" x 8" ceiling construction.

Model No.	Description	Std. Pk.	List Price	Code
161	Single 250W Bulb Heat — Not Type IC	1	\$53.78	HV
162	Single 250W Bulb Heat with 70 CFM, 4.0 Sones Exhaust Fan — Type IC, UL Listed for 60°C wiring (retrofit)	1	\$112.12	HV
163	Double 250W Bulb Heat Lamp — Type IC	1	\$89.48	HV
164	Double 250W Bulb Heat with 70 CFM, 4.0 Sones Exhaust Fan	1	\$149.60	HV

Select models available in project packs, see Page 70.

Rough-in housing sizes: 161 — 8-3/8" x 8-1/8" x 6"
 162 — 8-3/8" x 8-1/8" x 6-3/8"
 163 — 8-3/8" x 14-1/4" x 6"
 164 — 8-3/8" x 14-1/4" x 6-3/8"

Broan® Room-to-Room Fans

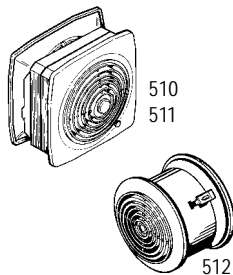

Install in interior walls to provide air flow of heated or cooled air from one room to another. Permanently lubricated motor. Models 510 and 511 have built-in switch for variable speed sound level selection. Models 510 and 511 adjust to fit walls from 3" to 5-1/2" thick.

Model No.	Description	Std. Pk.	List Price	Code
510	10" Fan, 380 CFM, 6.5 Sones. 13-1/2" square plastic grille.	1	\$216.68	HV
511	8" Fan, 180 CFM, 3.5 Sones. 13-1/2" square plastic grille.	1	\$173.60	HV
512	6" Fan with 8" Diameter Plastic Grille, 90 CFM, 3.5 Sones. Installs in interior walls up to 5-1/8" thick. Use with Model 57W/57V speed control or 69W/69V on/off switch (available separately).	1	\$76.68	HV

Broan® Through the Wall Fan

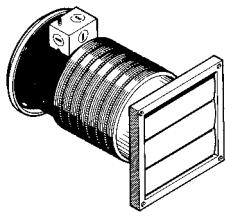

This versatile unit can be installed in outside walls from 5-1/4" to 10" thick. Exterior, white louvered, polymeric wall cap blends with any exterior wall covering. Includes white plastic interior grille, fan, flexible ducting and exterior louvered wall cap with birdscreen. Interior grille measures 8" round. Wall cap measures 8" square.

Model No.	Description	Std. Pk.	List Price	Code
512M	Through the Wall Ventilator, 70 CFM, 3.5 Sones	1	\$109.52	HV

● Item too large to ship via UPS/FedEx. Item shipped common carrier at minimum rates.
 * All pricing reflects the individual item cost. You must order in multiples as indicated.
 ◆ UL listed for use over bathtubs and showers when connected to a GFCI protected branch circuit.

Ventilation Fans — Utility

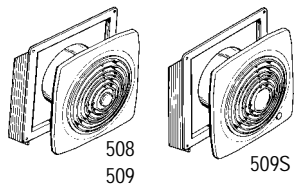

Broan® Direct Discharge Fans

Housing adjusts to fit walls 4-1/2" to 9-1/2" thick. Permanently lubricated motor with "twist-lock" installation; built-in backdraft damper.

Model No.	Description	Std. Pk.	List Price	Code
508	270 CFM, 10" Fan, 6.0 Sones, 13-1/2" square plastic grille	1	\$241.22	HV
509	180 CFM, 8" Fan, 6.5 Sones, 11-1/2" square plastic grille	1	\$160.52	HV
509S	8" Fan. Same as Model 509 (built-in on/off switch included).	1	\$169.72	HV

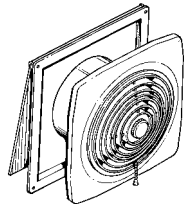

Broan® Chain-Operated Fans

Pull chain opens door and turns on fan – no wall switch to wire. Specially designed high performance fan blade. Housing adjusts to fit walls 4-1/2" to 9-1/2" thick.

Model No.	Description	Std. Pk.	List Price	Code
506	470 CFM, 10" Fan, 8.0 Sones, 13-1/2" square plastic grille	1	\$241.22	HV
507	250 CFM, 8" Fan, 7.0 Sones, 11-1/2" square plastic grille	1	\$196.18	HV

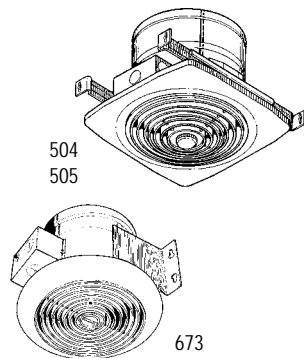

Broan® Vertical Discharge Fans

Quiet, efficient operation. Model 504 uses a 10" round duct or can be used with Model 472 reducer-damper (available separately) for 8" round duct. Housing is 10-1/4" x 7". Model 505 has a built-in backdraft damper, uses 8" round duct. Housing is 8-1/4" x 7".

Model No.	Description	Std. Pk.	List Price	Code
504	350 CFM, 10" Fan, 6.5 Sones, 13-1/2" square plastic grille	1	\$190.24	HV
505	180 CFM, 8" Fan, 5.5 Sones, 11-1/2" square plastic grille	1	\$136.64	HV
673	◆ Ventilation Fan, 60 CFM, 4.5 Sones	1	\$61.72	LV

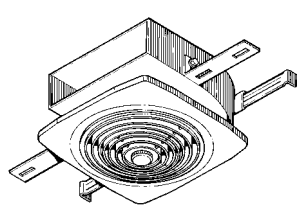

Broan® Side Discharge Fans

Mounting brackets are adjustable to allow installation in walls or ceilings with studs or joists up to 24" on center. Requires 3-1/4" x 10" duct. Housing has built-in backdraft damper. Model 502 housing is 16-3/4" x 13-7/8". Model 503 housing is 14" x 12".

Model No.	Description	Std. Pk.	List Price	Code
502	270 CFM, 10" Fan, 8.0 Sones, 13-1/2" square plastic grille	1	\$241.48	HV
503	160 CFM, 8" Fan, 5.0 Sones, 11-1/2" square plastic grille	1	\$160.34	HV

● Item too large to ship via UPS/FedEx. Item shipped common carrier at minimum rates.
 * All pricing reflects the individual item cost. You must order in multiples as indicated.
 ◆ UL listed for use over bathtubs and showers when connected to a GFCI protected branch circuit.

Ventilation Fans — Utility

Broan® Metal Grille Kits and Filters — Utility Fans

Everything you need to furnish a heavy duty metal grille for most Broan Utility Ventilators. All mounting hardware included.

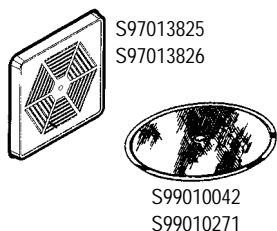

Model No.	Description	Std. Pk.	List Price	Code
S97013825	White Painted Steel Metal Grille Kit for 10" fan units without switch hole	1	\$48.94	PT
S97013826	White Painted Steel Metal Grille Kit for 8" fan units without switch hole	1	\$37.24	PT
S97013827	White Painted Steel Metal Grille Kit for 10" fan units with switch hole	1	\$54.02	PT
S99010042	Washable Aluminum Filter for use with 8" utility ventilators	1	\$10.98	PT
S99010271	Washable Aluminum Filter for use with 10" utility ventilators	1	\$13.70	PT

Ventilation Fans — High Capacity

Broan® Ceiling Mount Ventilators — 100, 150, 200, 250 and 300 CFM

Incredibly Reliable – Unbelievably Quiet!® The quietest in the industry — Single, impact resistant centrifugal blower wheel driven by low RPM motor. 12-1/4" x 12-1/2" x 11-3/4" high housing. Low profile white polymeric grille (14" x 14") or sturdy, low profile metal grille finished with painted white enamel (14" x 14"). Built-in backdraft damper. Discharges horizontally or vertically through 6" or 8" round duct. Housings lined with acoustic insulation (except Model L300KMG). All ratings at 60 Hz.

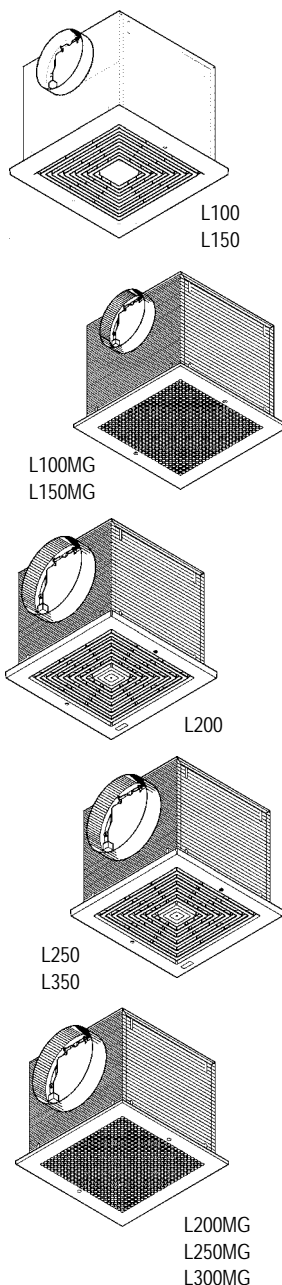

Model No.	Description *	Std. Pk.	List Price	Code
L100	Ventilator; 109 CFM Horizontal, 0.9 Sones; 112 CFM Vertical, 1.0 Sones. Polymeric grille. 6" rd. duct connector. 120V.	1	\$253.30	HV
L100MG	Ventilator; 115 CFM Horizontal/Vertical, 0.9 Sones. Metal grille. 6" rd. duct connector. 120V.	1	\$280.72	HV
L150	Ventilator; 157 CFM Horizontal, 1.5 Sones; 160 CFM Vertical, 1.6 Sones. Polymeric grille. 6" rd. duct connector. 120V.	1	\$261.84	HV
L150MG	Ventilator; 161 CFM Horizontal, 1.4 Sones; 162 CFM Vertical, 1.6 Sones. Metal grille. 6" rd. duct connector. 120V.	1	\$289.32	HV
L200	Ventilator; 210 CFM Horizontal, 1.7 Sones; 207 CFM Vertical, 2.0 Sones. Polymeric grille. 8" rd. duct connector. 120V.	1	\$288.58	HV
L200MG	Ventilator; 215 CFM Horizontal, 1.9 Sones; 209 CFM Vertical, 1.8 Sones. Metal grille. 8" rd. duct connector. 120V.	1	\$316.04	HV
L250	Ventilator; 259 CFM Horizontal, 2.2 Sones; 259 CFM Vertical, 2.7 Sones. Polymeric grille. 8" rd. duct connector. 120V.	1	\$305.68	HV
L250MG	Ventilator; 265 CFM Horizontal, 2.5 Sones; 262 CFM Vertical, 2.7 Sones. Metal grille. 8" rd. duct connector. 120V.	1	\$333.10	HV
L300	Ventilator; 308 CFM Horizontal, 2.9 Sones; 313 CFM Vertical, 3.0 Sones. Polymeric grille. 8" rd. duct connector. 120V.	1	\$312.30	HV
L300MG	Ventilator; 316 CFM Horizontal, 3.0 Sones; 314 CFM Vertical, 2.8 Sones. Metal grille. 8" rd. duct connector. 120V.	1	\$339.74	HV
L300KMG ▲	Ventilator; 277 CFM Horizontal, 3.1 Sones; 277 CFM Vertical, 3.7 Sones. Metal grille and blower wheel. 8" rd. duct connector. Suitable for kitchen installation. 120V.	1	\$360.54	HV

* AMCA licensed CFM/Sone ratings at 0.125" static pressure.

▲ Indicates product is suitable for kitchen installation.

- Item too large to ship via UPS/FedEx. Item shipped common carrier at minimum rates.
- * All pricing reflects the individual item cost. You must order in multiples as indicated.
- ◆ UL listed for use over bathtubs and showers when connected to a GFCI protected branch circuit.

Broan® Ceiling Mount Ventilators — 400, 500 and 700 CFM

Two impact resistant centrifugal blower wheels driven by low RPM motor (kitchen units have metal wheels). 21-1/2" x 21-1/4" x 11-3/4" high housing. Sturdy, low profile metal grille finished with painted white enamel (20" x 14"). Discharges horizontally or vertically through 4-1/2" x 18-1/2" duct connector. Housings lined with acoustic insulation (except kitchen models). All ratings at 60 Hz.

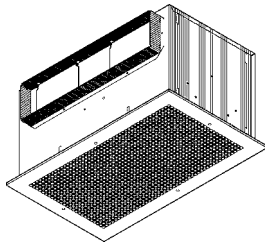

Model No.	Description *	Std. Pk.	List Price	Code
L400	Ventilator; 434 CFM Horizontal, 2.3 Sones; 416 CFM Vertical, 2.6 Sones. 120V.	1	\$423.18	HV
L400K ▲	Ventilator; 406 CFM Horizontal, 3.3 Sones; 399 CFM Vertical, 3.3 Sones. Metal wheels. 120V.	1	\$460.28	HV
L500	Ventilator; 514 CFM Horizontal, 3.3 Sones; 512 CFM Vertical, 3.2 Sones. 120V.	1	\$512.20	HV
L500K ▲	Ventilator; 481 CFM Horizontal, 4.4 Sones; 473 CFM Vertical, 4.0 Sones. Metal wheels. 120V.	1	\$549.26	HV
L700	Ventilator; 701 CFM Horizontal, 4.7 Sones; 687 CFM Vertical; 5.0 Sones. 120V.	1	\$601.22	HV
423	Duct Transition — 4-1/2" x 18-1/2" to 10" rd. for 400, 500 & 700 CFM models	1	\$73.38	AC

* AMCA licensed CFM/Sone ratings at 0.125" static pressure.

▲ Indicates product is suitable for kitchen installation.

Broan® Ceiling Mount Ventilators — 900 and 1500 CFM

Single, impact resistant centrifugal blower wheel driven by low RPM motor. 22" x 18" x 18" high housing. Sturdy, low profile metal grille finished with painted white enamel (23-7/8" x 19-7/8"). Discharges horizontally or vertically through 8" x 12" duct connector. Housings lined with acoustic insulation. All ratings at 60 Hz.

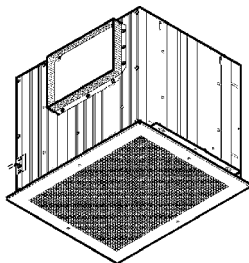

Model No.	Description *	Std. Pk.	List Price	Code
L900	Ventilator; 901 CFM Horizontal, 4.1 Sones; 885 CFM Vertical, 3.4 Sones. 120V.	1	\$759.36	HV
L1500	Ventilator; 1513 CFM Horizontal, 8.4 Sones; 1502 CFM Vertical, 8.4 Sones. 120V.	1	\$848.44	HV
T81212	Duct Transition — 8" x 12" to 12" rd. for 900 & 1500 CFM models	1	\$74.46	AC

* AMCA licensed CFM/Sone ratings at 0.125" static pressure.

- Item too large to ship via UPS/FedEx. Item shipped common carrier at minimum rates.
- * All pricing reflects the individual item cost. You must order in multiples as indicated.
- ◆ UL listed for use over bathtubs and showers when connected to a GFCI protected branch circuit.

Ventilation Fans — High Capacity

Broan® In-Line Ventilators — 100, 150, 200, 250 and 300 CFM

Single impact resistant centrifugal blower wheel driven by low RPM motor. 12-1/4" x 12-1/2" x 11-3/4" high housing. Removable access panel. No insulation inside housing.

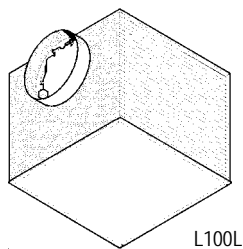

L100L

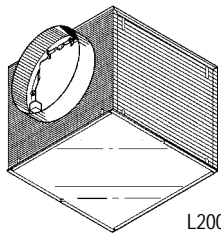

L200L

Model No.	Description *	Std. Pk.	List Price	Code
L100L	▲ Ventilator; 106 CFM Straight Through, 0.7 Sones; 95 CFM Right Angle, 0.3 Sones. 6" rd. duct connectors. 120V.	1	\$273.32	HV
L150L	▲ Ventilator; 147 CFM Straight Through, 1.1 Sones; 142 CFM Right Angle, 1.3 Sones. 6" rd. duct connectors. 120V.	1	\$281.92	HV
L200L	▲ Ventilator; 195 CFM Straight Through, 1.9 Sones; 183 CFM Right Angle, 1.0 Sones. 8" rd. duct connectors. 120V.	1	\$309.20	HV
L250L	▲ Ventilator; 245 CFM Straight Through, 2.3 Sones; 238 CFM Right Angle, 1.7 Sones. 8" rd. duct connectors. 120V.	1	\$326.24	HV
L300L	▲ Ventilator; 293 CFM Straight Through, 3.1 Sones; 283 CFM Right Angle, 2.4 Sones. 8" rd. duct connectors. 120V.	1	\$332.92	HV

* AMCA licensed CFM/Sone ratings at 0.125" static pressure.

▲ Indicates product is suitable for kitchen installation.

Broan® In-Line Ventilators — 400, 500 and 700 CFM

Two impact resistant centrifugal blower wheels driven by low RPM motor. 21-1/2" x 21-1/4" x 11-3/4" high housing. Two 4-1/2" x 18-1/2" duct connectors. Removable access panel.

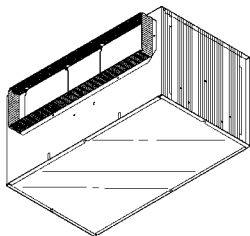

Model No.	Description *	Std. Pk.	List Price	Code
L400L	Ventilator; 406 CFM Straight Through, 1.6 Sones; 391 CFM Right Angle, 1.2 Sones. 120V.	1	\$454.70	HV
L400KL	▲ Ventilator; 375 CFM Straight Through, 3.1 Sones; 380 CFM Right Angle, 2.0 Sones. 120V.	1	\$491.88	HV
L500L	Ventilator; 519 CFM Straight Through/Right Angle, 3.4 Sones. 120V.	1	\$543.78	HV
L500KL	▲ Ventilator; 472 CFM Straight Through, 3.8 Sones; 459 CFM Right Angle, 1.8 Sones. 120V.	1	\$580.88	HV
L700L	Ventilator; 681 CFM Straight Through, 3.7 Sones; 629 CFM Right Angle, 2.7 Sones. 120V.	1	\$632.78	HV
423	Duct Transition — 4-1/2" x 18-1/2" to 10" rd. for 400, 500 & 700 CFM models	1	\$73.38	AC

* AMCA licensed CFM/Sone ratings at 0.125" static pressure.

▲ Indicates product is suitable for kitchen installation.

Broan® In-Line Ventilators — 900 and 1500

Single impact resistant centrifugal blower wheel driven by low RPM motor. 22" x 18" x 18" high housing. Two 8" x 12" duct connectors. Removable access panel.

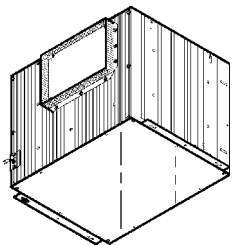

Model No.	Description *	Std. Pk.	List Price	Code
L900L	Ventilator; 894 CFM Straight Through, 3.8 Sones; 858 CFM Right Angle, 3.4 Sones. 120V.	1	\$796.64	HV
L1500L	Ventilator; 1214 CFM Straight Through, 6.7 Sones; 1076 CFM Right Angle, 3.5 Sones. 120V.	1	\$885.64	HV
T81212	Duct Transition — 8" x 12" to 12" rd. for 900 & 1500 CFM models	1	\$74.46	AC

* AMCA licensed CFM/Sone ratings at 0.125" static pressure.

- Item too large to ship via UPS/FedEx. Item shipped common carrier at minimum rates.
- * All pricing reflects the individual item cost. You must order in multiples as indicated.
- ◆ UL listed for use over bathtubs and showers when connected to a GFCI protected branch circuit.

Ventilation Fans — High Capacity

Broan® Cabinet Ventilators — 2000 and 3500 CFM

Twin, double inlet metal blower wheels 8" x 7-7/8". Fits 7-3/4" x 33-3/4" duct. Ratings at 60 Hz.

Model No.	Description *	Std. Pk.	List Price	Code
L2000L	Ventilator; 1791 CFM Straight Through, 9.4 Sones; 1898 CFM Right Angle, 10.1 Sones. 120V.	1	\$1,270.66	HV
L3500EXL	Ventilator; 3452 CFM Straight Through, 14.5 Sones; 3696 CFM Right Angle, 14.2 Sones. 240V	1	\$1,758.92	HV

* AMCA licensed CFM/Sone ratings at 0.125" static pressure.

Broan® Accessories for High Capacity Ventilation Fans

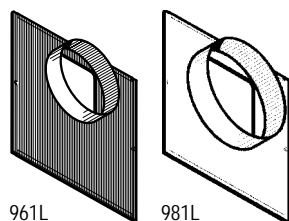

961L

981L

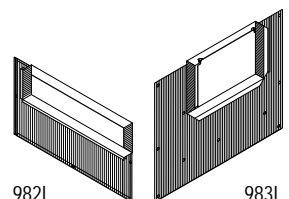

982L

983L

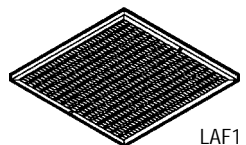

LAF1

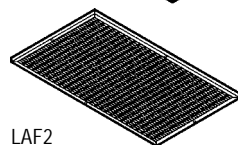

LAF2

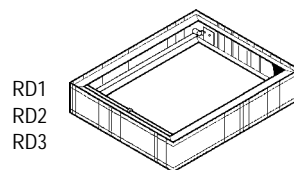

RD1

RD2

RD3

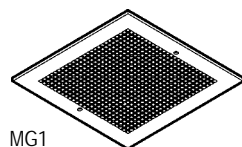

MG1

Model No.	Description	Std. Pk.	List Price	Code
80L	Variable Speed Control — 3.0 Amp, 120 Volts, 60 Hz (may be used with select models).	1	\$53.02	AC
277V	Electronic Variable Speed Control, 277V, 6A — Ivory. For models with "C" suffix.	1	\$95.26	AC
423	Duct Transition — 4-1/2" x 18-1/2" to 10" rd. for 400, 500 & 700 CFM models	1	\$73.38	AC
961L	In-line Adapter Kit, 6" rd. for 100 & 150 CFM ceiling mount models	1	\$32.54	AC
981L	In-line Adapter Kit, 8" rd. for 200, 250 & 300 CFM ceiling mount models	1	\$32.54	AC
982L	In-line Adapter Kit, 4-1/2" x 18-1/2" for 400, 500 & 700 CFM ceiling mount models	1	\$41.40	AC
983L	In-line Adapter Kit, 8" x 12" for 900 & 1500 CFM ceiling mount models	1	\$44.34	AC
D101	Damper Kit for Model L3500EXL Ventilator. Twin damper flaps and mounting hardware.	1	\$34.80	AC
G102	Grille Kit for Model L2000L Ventilator. White enameled steel grille measures 16-1/4" x 39-5/8".	1	\$155.56	AC
G103	Grille Kit for Model L3500EXL Ventilator. White enameled steel grille measures 18-3/8" x 47-1/4".	1	\$200.44	AC
LAF1	Grease Filter for use with metal grilles — Models L100, L150, L200, L250 and L300 Series.	1	\$16.02	AC
LAF2	Grease Filter for Models L400K & L500K	1	\$27.62	AC
MG1	Metal Grille Kit for 100, 150, 200, 250 & 300 CFM ceiling mount models	1	\$38.44	AC
RD1	Ceiling Radiation/Fire Damper for 100, 150, 200, 250 & 300 CFM ceiling mount models. UL rated 3 hours.	1	\$177.90	AC
RD2	Ceiling Radiation/Fire Damper for 400, 500 & 700 CFM ceiling mount models. UL rated 3 hours.	1	\$189.78	AC
RD3	Ceiling Radiation/Fire Damper for 900 & 1500 CFM ceiling mount models. UL rated 3 hours.	1	\$237.26	AC
T81212	Duct Transition, 8" x 12" to 12" rd. for 900 & 1500 CFM models	1	\$74.46	AC
V104	Vibration Dampening Hangers. Fits both Models L2000L and L3500EXL ventilators. Set of four required.	4 *	\$24.84	AC

● Item too large to ship via UPS/FedEx. Item shipped common carrier at minimum rates.

* All pricing reflects the individual item cost. You must order in multiples as indicated.

◆ UL listed for use over bathtubs and showers when connected to a GFCI protected branch circuit.

Broan SmartSense® Intelligent Ventilation System

The intelligent fan control system creates an integrated residential exhaust ventilation system using Broan's industry leading ventilation control technology and award winning QTXE fans. The Broan SmartSense system uses Broan's Link-Logic™ control technology powered by INSTEON™, a powerful communication technology to monitor everyday manual fan usage throughout the home. Broan SmartSense calculates additional ventilation required by Green Building and ASHRAE Standard 62 related requirements and automatically controls installed fans to achieve proper ventilation. SSQTXE080 and SSQTXE110 fans can provide a single fan solution for small apartments or mix and matched for a customized, integrated ventilation system.

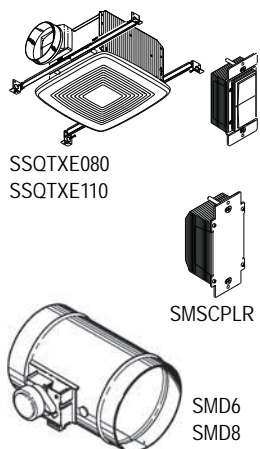

Model No.	Description	Std. Pk.	List Price	Code
SSQTXE080	80 CFM SmartSense Fan with Control	1	\$298.54	HV
SSQTXE110	110 CFM SmartSense Fan with Control	1	\$331.60	HV
SMSCPLR †	SmartSense Phase Coupler	1	\$47.74	AR
SMD6	6" LinkLogic automatic make-up air damper	1	\$292.62	HA
SMD8	8" LinkLogic automatic make-up air damper	1	\$308.00	HA

† The SmartSense Phase Coupler is only required when fans are located on separate phases of power. If fans are on the same circuit or phase, the phase coupler is not necessary.

Broan® Fresh Air Systems — Balanced Ventilation

The key to maintaining good indoor air quality and controlling excess moisture is to simultaneously introduce fresh air from outside while expelling stale air from inside. All without compromising your home's energy-efficiency or comfort. That's precisely what Broan's indoor air quality units do. With unparalleled performances, easy maintenance and reliability, the I.A.Q. line offers solutions to every budget and application, from residential to light-commercial.

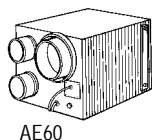

Model No.	Description	Std. Pk.	List Price	Code
AE60	Air Exchanger, 160 – 185 CFM	1	\$841.78	AQ
B6LCDARN	Light Commercial Heat Recovery Ventilator, recirculation defrost, aluminum core, reverse door, normal low speed	1	\$6,536.86	AQ
B6LCDASN	Light Commercial Heat Recovery Ventilator, recirculation defrost, aluminum core, standard door, normal low speed	1	\$6,536.86	AQ
B6LCDHRN	Light Commercial Energy Recovery Ventilator, recirculation defrost, Polymerized paper ERV HM, reverse door, normal low speed	1	\$6,921.02	AQ
B6LCDPRN	Light Commercial Heat Recovery Ventilator, recirculation defrost, polypropylene core, reverse door, normal low speed	1	\$6,080.08	AQ
B6LCDPSN	Light Commercial Heat Recovery Ventilator, recirculation defrost, polypropylene core, standard door, normal low speed	1	\$6,080.08	AQ
B6LCEARN	Light Commercial Heat Recovery Ventilator, exhaust only, aluminum core, reverse door, normal low speed	1	\$5,222.38	AQ
B6LCEASN	Light Commercial Heat Recovery Ventilator, exhaust only, aluminum core, standard door, normal low speed	1	\$5,222.38	AQ
B6LCEHRN	Light Commercial Energy Recovery Ventilator, exhaust only, Polymerized paper ERV HM, reverse door, normal low speed	1	\$5,410.28	AQ
B6LCEHSN	Light Commercial Energy Recovery Ventilator, exhaust only, Polymerized paper ERV HM, standard door, normal low speed	1	\$5,410.28	AQ
B6LCEPRN	Light Commercial Heat Recovery Ventilator, exhaust only, polypropylene core, reverse door, normal low speed	1	\$4,765.62	AQ
B6LCEPSN	Light Commercial Heat Recovery Ventilator, exhaust only, polypropylene core, standard door, normal low speed	1	\$4,765.62	AQ
B12LCDARNW	Light Commercial Heat Recovery Ventilator, recirculation defrost, aluminum core, reverse door, normal low speed, white pre paint	1	\$7,888.56	AQ
B12LCDASNW	Light Commercial Heat Recovery Ventilator, recirculation defrost, aluminum core, standard door, normal low speed, white pre paint	1	\$7,888.56	AQ
B12LCDHRNW	Light Commercial Energy Recovery Ventilator, recirculation defrost, Polymerized paper ERV HM, reverse door, normal low speed, white pre paint	1	\$8,271.72	AQ
B12LCDHSNW	Light Commercial Energy Recovery Ventilator, recirculation defrost, Polymerized paper ERV HM, Standard door, Normal low speed, White pre paint	1	\$8,271.72	AQ



Select models are ENERGY STAR certified products — see product description.

- Item too large to ship via UPS/FedEx. Item shipped common carrier at minimum rates.
- * All pricing reflects the individual item cost. You must order in multiples as indicated.
- ◆ UL listed for use over bathtubs and showers when connected to a GFCI protected branch circuit.

Broan® Fresh Air Systems — Balanced Ventilation CONTINUED

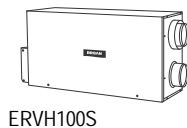
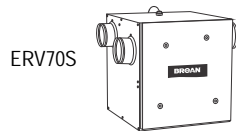

Model No.	Description	Std. Pk.	List Price	Code
B12LCDPRNC	Light Commercial Heat Recovery Ventilator, recirculation defrost, polypropylene core, reverse door, normal low speed, corrosion resistant	1	\$8,292.88	AQ
B12LCDPRNW	Light Commercial Heat Recovery Ventilator, recirculation defrost, polypropylene core, reverse door, normal low speed, white pre paint	1	\$7,156.04	AQ
B12LCDPSNC	Light Commercial Heat Recovery Ventilator, recirculation defrost, polypropylene core, standard door, normal low speed, corrosion resistant	1	\$8,292.88	AQ
B12LCDPSNW	Light Commercial Heat Recovery Ventilator, recirculation defrost, polypropylene core, standard door, normal low speed, white pre paint	1	\$7,156.04	AQ
B12CEARNW	Light Commercial Heat Recovery Ventilator, exhaust only, aluminum core, reverse door, normal low speed, white pre paint	1	\$7,416.58	AQ
B12CEASNW	Light Commercial Heat Recovery Ventilator, exhaust only, aluminum core, standard door, normal low speed, white pre paint	1	\$7,416.58	AQ
B12CEHRNW	Light Commercial Energy Recovery Ventilator, exhaust only, Polymerized paper ERV HM, reverse door, normal low speed, white pre paint	1	\$7,631.80	AQ
B12CEHSNW	Light Commercial Energy Recovery Ventilator, exhaust only, Polymerized paper ERV HM, standard door, normal low speed, white pre paint	1	\$7,631.80	AQ
B12CEPRNC	Light Commercial Heat Recovery Ventilator, exhaust only, polypropylene core, reverse door, normal low speed, corrosion resistant	1	\$7,820.88	AQ
B12CEPRNW	Light Commercial Heat Recovery Ventilator, exhaust only, polypropylene core, reverse door, normal low speed, white pre paint	1	\$6,684.04	AQ
B12CEPSNC	Light Commercial Heat Recovery Ventilator, exhaust only, polypropylene core, standard door, normal low speed, corrosion resistant	1	\$7,820.88	AQ
B12CEPSNW	Light Commercial Heat Recovery Ventilator, exhaust only, polypropylene core, standard door, normal low speed, white pre paint	1	\$6,684.04	AQ
B1600705	Light Commercial Heat Recovery Ventilator Pool	1	\$7,467.30	AQ
ERV70S	Energy Recovery Ventilator, 70 CFM max, side ports	1	\$1,296.64	AQ
ERV70T	Energy Recovery Ventilator, 70 CFM max, top ports	1	\$1,296.64	AQ
ERV100S	Sky Energy Recovery Ventilator, 100 CFM, side port	1	\$1,426.42	AQ
ERV100SP	Sky Energy Recovery Ventilator, 100 CFM, plus side port	1	\$1,556.22	AQ
ERV110S	Compact Flex™ Heat Recovery Ventilator, 110 CFM, side port	1	\$1,421.22	AQ
ERV110T	Compact Flex™ Heat Recovery Ventilator, 110 CFM, top port	1	\$1,421.22	AQ
ERV120S	Compact Flex™ Energy Recovery Ventilator, 120 CFM, side port	1	\$1,491.32	AQ
ERV120T	Compact Flex™ Energy Recovery Ventilator, 120 CFM, top port	1	\$1,491.32	AQ
ERV130FLS	Advanced Series High Efficiency Energy Recovery Ventilator, 129 CFM at 0.4 in. w.g.	1	\$1,404.00	AQ
ERV140TE	Energy Recovery Ventilator, 140 CFM max, top ports, ENERGY STAR certified.	1	\$2,594.56	AQ
ERV180S	Advance Energy Recovery Ventilator, 180 CFM, side port	1	\$1,945.60	AQ
ERV200TE	HE Energy Recovery Ventilator, 200 CFM, ECM, top port	1	\$3,691.86	AQ
ERV250TE	HE Energy Recovery Ventilator, 250 CFM, ECM, top port	1	\$3,115.00	AQ
ERVH100S	Energy Recovery Ventilator, 100 CFM max, side ports, ENERGY STAR certified.	1	\$2,075.38	AQ
ERVS100S	Sky Energy Recovery Ventilator, 100 Humidity Sensing, side port	1	\$1,106.56	AQ
HRV80S	Compact Flex™ Heat Recovery Ventilator, 80 CFM, side port	1	\$1,067.40	AQ
HRV80T	Compact Flex™ Heat Recovery Ventilator, 80 CFM, top port	1	\$1,067.40	AQ
HRV90S	Compact Flex™ Heat Recovery Ventilator, 90 CFM, side port	1	\$1,200.58	AQ
HRV90T	Compact Flex™ Heat Recovery Ventilator, 90 CFM, top port	1	\$1,200.58	AQ
HRV120S	Compact Flex™ Heat Recovery Ventilator, 120 CFM, side port	1	\$1,296.64	AQ
HRV120T	Compact Flex™ Heat Recovery Ventilator, 120 CFM, top port	1	\$1,296.64	AQ



Select models are ENERGY STAR certified products — see product description.

- Item too large to ship via UPS/FedEx. Item shipped common carrier at minimum rates.
- * All pricing reflects the individual item cost. You must order in multiples as indicated.
- ◆ UL listed for use over bathtubs and showers when connected to a GFCI protected branch circuit.

Broan® Fresh Air Systems — Balanced Ventilation CONTINUED

Model No.	Description	Std. Pk.	List Price	Code
HRV130FLS	Advanced Series High Efficiency Heat Recovery Ventilator, 129 CFM at 0.4 in. w.g.	1	\$1,352.00	AQ
HRV150FLS	Advanced Series High Efficiency Heat Recovery Ventilator, 150 CFM at 0.4 in. w.g.	1	\$1,789.36	AQ
HRV150S	Advance Heat Recovery Ventilator, 150 CFM, side port	1	\$1,680.80	AQ
HRV160T	Advance Heat Recovery Ventilator, 160 CFM, top port	1	\$1,615.92	AQ
HRV160TE	HE Heat Recovery Ventilator, 160 CFM, ECM, top port	1	\$1,945.60	AQ
HRV190FLS	Advance Heat Recovery Ventilator, 192 CFM, side port	1	\$2,142.40	AQ
HRV190S	Advance Heat Recovery Ventilator, 190 CFM	1	\$1,945.60	AQ
HRV200TE	HE Heat Recovery Ventilator, 200 CFM, ECM, top port	1	\$2,855.42	AQ
HRV250TE	HE Heat Recovery Ventilator, 250 CFM, DCM, top port	1	\$2,999.66	AQ
HRVH100S	Advance Heat Recovery Ventilator, HEPA, 100 CFM, side port	1	\$1,556.22	AQ

Broan® Fresh Air Systems — Fresh In™ Supply Fans

Set it, forget it, and ventilate in a smart, code-compliant manner or select one of our comfort modes. Ultra compact, Broan Fresh In™ supply fans can be install easily between ceiling joists, mounting flush to the ceiling, in the attic or wall-mounted. With an optional finishing ring and a paintable filter access door, the ventilator blends in wherever it is installed.

Model No.	Description	Std. Pk.	List Price	Code
FIN-180B	Fresh In Basic, Selectable CFM: 30–180 CFM, 10 CFM increments	1	\$290.00	KS
FIN-180P	Fresh In Premium, Intermittent (% running time) for unit intelligence: 130 and 180 CFM time based adjustment	1	\$380.00	KS

- Item too large to ship via UPS/FedEx. Item shipped common carrier at minimum rates.
- * All pricing reflects the individual item cost. You must order in multiples as indicated.
- ◆ UL listed for use over bathtubs and showers when connected to a GFCI protected branch circuit.

Broan® Fresh Air System Accessories

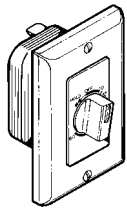

59W 61W
59V 61V



82W

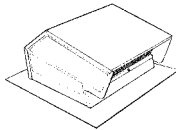

634M

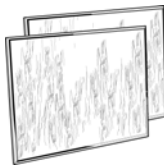

ACCGSFP2

ACCGSFH



Model No.	Description	Std. Pk.	List Price	Code
59V / 59W	60 Minute Time Control, with "continuous on" feature. Fits single gang box.	1	\$62.76	AC
61V / 61W	15 Minute Time Control, no "continuous on" feature. Fits single gang box.	1	\$62.76	AC
82W	Premium Humidity Control with Sensaire technology that senses rapid rise in humidity. Also includes duty cycle timer. Fits in single gang box. (White)	1	\$105.36	AC
634M	Steel Roof Cap for 6" round duct. Includes damper and birdscreen. Black.	1	\$63.36	AC
641	Aluminum Wall Cap for 6" round duct (includes damper and birdscreen). Natural finish.	1	\$74.60	AC
ACCGSEF2	2-Core Foam Filter Kit	1	\$41.40	GA
ACCGSFF2	HRV Core Foam Filters (Two Pieces)	1	\$41.38	GA
ACCGSFH	HEPA Filter Only	1	\$175.44	GA
ACCGSFHP2	1 Year HEPA Filter Kit (Two pre-filters and one HEPA)	1	\$206.44	GA
ACCGSFHP10	1 Year HEPA Filter Multi-Pack (Ten ACCGSFHP2)	1	\$1,956.24	GA
ACCGSFP2	Pre-filter Kit (Two Pieces)	1	\$38.14	GA
ACCGSFP20	Pre-filter Multi-Pack (Ten ACCGSFP2)	1	\$367.58	GA

- Item too large to ship via UPS/FedEx. Item shipped common carrier at minimum rates.
- * All pricing reflects the individual item cost. You must order in multiples as indicated.
- ◆ UL listed for use over bathtubs and showers when connected to a GFCI protected branch circuit.

Broan® Fresh Air System Accessories CONTINUED

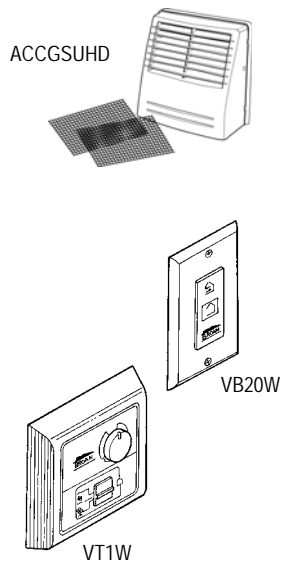

Model No.	Description	Std. Pk.	List Price	Code
ACCGSUHD ■	AirDuo Outdoor Hood	1	\$59.26	GA
BD4	Pressure Relief Damper with Wall Cap and 4" collar	1	\$87.34	AC
BD6	Pressure Relief Damper with Wall Cap and 6" collar	1	\$87.34	AC
DT4C	Flex Duct, 4", Non-insulated (25')	4 *	\$51.34	AC
DT4W	Flex Duct, 4", Insulated (25')	1	\$74.58	AC
DT6C	Flex Duct, 6", Non-insulated (25')	1	\$67.22	AC
DT6W	Flex Duct, 6", Insulated (25')	1	\$104.34	AC
EH6	Exterior Inlet/Outlet Hood, 6"	1	\$79.76	AQ
FIN-MERV8	Fresh In Filter MERV8 for FIN-180B and FIN-180P	10 *	\$34.56	KS
FIN-MERV13	Fresh In Filter MERV13 for FIN-180B and FIN-180P	10 *	\$66.00	KS
FIN-R1015	Fresh In Finish Ring 10 x 15 for FIN-180B and FIN-180P	1	\$50.00	KS
V14695	Metal Tandem Hood for ERV120T/ERV120S	1	\$315.04	AQ
V21030	MERV8 Filter Kit for ERV100S/ERV100SP	1	\$20.58	AQ
V21996	HEPA Filter for HRV200TE, HRV250TE and ERV250TE	1	\$105.40	AQ
V22528	HEPA Filter for ERV200TE	1	\$105.40	AQ
V61239	Chains and Springs Kit for ERV100S	1	\$55.18	AQ
VACCWMK	Wall Brackets Kit	1	\$72.82	AQ
VB20W ▲	20-Minute Push Button Timer	1	\$32.92	AQ
VB60W	20/40/60 Minute Wall Control	1	\$47.80	AQ
VT1W □	Basic Wall Control. Off-low-high rocker switch. Dehumidistat. Low Voltage.	1	\$63.60	AQ
VT4W ‡	Wall Control, Off/Low/High Speed/Intermittent 20 min./hour	1	\$88.38	AQ
VT6W	Constructo Wall Control	1	\$59.40	AQ
VT7W	Deco-Touch Wall Control	1	\$174.54	AQ
VT8W	Altitude Wall Control	1	\$282.84	AQ
VT9W	HE Wall Control	1	\$216.32	AQ
VT10W	Pool Plus Wall Control	1	\$306.82	AQ
VT11W	Wall Control for FIN-180P only	1	\$31.66	KS
VTYIK1	Installation Kit (Tandem Y, complete exterior vent, screws)	1	\$130.50	AQ

‡ Can be used with HRV90H and ERV90HC.

▲ Can be used with all units except GSE, GSH, GSV and GSF units.

□ Can only be used with HRV100 and HRV200.

■ Limited quantities available.

● Item too large to ship via UPS/FedEx. Item shipped common carrier at minimum rates.

* All pricing reflects the individual item cost. You must order in multiples as indicated.

◆ UL listed for use over bathtubs and showers when connected to a GFCI protected branch circuit.

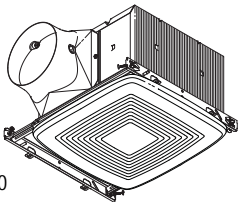

ZB80
ZB110

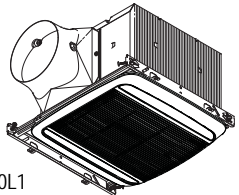

ZB80L1
ZB110L1

Broan® ULTRA™ Green Multi-Speed Series

We started with installation and worked back to build the ultimate bath fan. Unique telescoping mounting frame is ideal for both new construction and retrofit. No attic access needed! DC motor for efficiency. Multi-speed capability ideal for meeting ASHRAE 62.2, LEED, ENERGY STAR® for Homes and CA Title 24 — as well as local/spot ventilation needs. Powerful operation maintained over a wide range of real-world installations (CFM rating at 0.1" static pressure maintained through 0.25" static pressure). Fits in 2" x 8" ceiling construction. 10-1/2" L x 11-3/8" W x 7-5/8" H housing. 13" x 14" grille (fan) and 13" x 13-1/4" (fan/LED). All models have a 6" duct connector and the 50 CFM and 80 CFM models include a 6" to 4" reducer. All ULTRA 80 and 110 CFM fans can also be used with the MD6TU universal make-up air damper if 6" rigid duct is used. ULTRA non-sensing fans (not fan/lights) can also be used with the RDFU radiation damper. Now with QStream sound technology that features airflow-smoothing baffles to reduce noise caused by turbulence (50 and 80 CFM models only).

Model No.	Description	Std. Pk.	List Price	Code
Fans				
ZB80	◆ 30 CFM to 80 CFM, <0.3 Sones, ENERGY STAR Fan	1	\$321.30	HP
ZB110	◆ 30 CFM to 110 CFM, <0.3 Sones, ENERGY STAR Fan	1	\$351.18	HP
Fan/Light/Night Light				
ZB80L1	◆ 30 CFM to 80 CFM <0.3 Sones, ENERGY STAR Fan with Dual 18W Dimmable LEDs	1	\$440.62	HP
ZB110L1	◆ 30 CFM to 110 CFM <0.3 Sones, ENERGY STAR Fan with Dual 18W Dimmable LEDs	1	\$472.96	HP



All models are ENERGY STAR certified products.

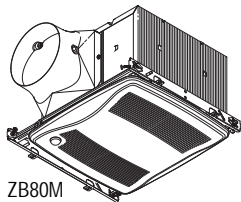

ZB80M
ZB110M

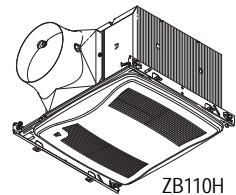

ZB110H

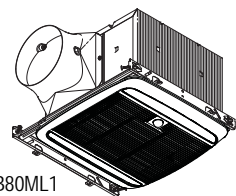

ZB80ML1
ZB110ML1

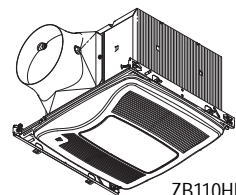

ZB110HL1

Broan® ULTRA™ Green Multi-Speed Series — Sensing

We started with installation and worked back to build the ultimate bath fan. Unique telescoping mounting frame is ideal for both new construction and retrofit. No attic access needed! DC motor for efficiency. Multi-speed capability ideal for meeting ASHRAE 62.2, LEED, ENERGY STAR® for Homes and CA Title 24 — as well as local/spot ventilation needs. Humidity or motion sensing triggers fan to ramp up from lower continuous ventilation level to maximum CFM. Powerful operation maintained over a wide range of real-world installations (CFM rating at 0.1" static pressure maintained through 0.25" static pressure). Fits in 2" x 8" ceiling construction. 10-1/2" L x 11-3/8" W x 7-5/8" H housing. 13" x 14" grille (fan) and 13" x 13-1/4" (fan/light/night light). All models have a 6" duct connector and the 80 CFM models include a 6" to 4" reducer. All ULTRA 80 and 110 CFM fans can also be used with the MD6TU universal make-up air damper if 6" rigid duct is used. ULTRA non-sensing fans (not fan/lights) can also be used with the RDFU radiation damper. Now with QStream sound technology that features airflow-smoothing baffles to reduce noise caused by turbulence (50 and 80 CFM models only).

Model No.	Description	Std. Pk.	List Price	Code
Fans				
ZB80M	◆ 80 CFM, <0.3 Sones, ENERGY STAR Motion Sensing Fan	1	\$371.04	HP
ZB110H	◆ 110 CFM, <0.3 Sones, ENERGY STAR Humidity Sensing Fan	1	\$466.78	HP
ZB110M	◆ 110 CFM, <0.3 Sones, ENERGY STAR Motion Sensing Fan	1	\$399.08	HP
Fan/Light/Night Light				
ZB80ML1	◆ 80 CFM, <0.3 Sones, ENERGY STAR Motion Sensing Fan with 36W Fluorescent Light (2-18 watt GU24 bulbs included) and 4W Night Light (bulb not included)	1	\$497.52	HP
ZB110HL1	◆ 110 CFM, <0.3 Sones, ENERGY STAR Humidity Sensing Fan with Dual 18W Dimmable LEDs	1	\$593.52	HP
ZB110ML1	◆ 110 CFM, <0.3 Sones, ENERGY STAR Motion Sensing Fan with 36W Fluorescent Light (2-18 watt GU24 bulbs included) and 4W Night Light (bulb not included)	1	\$532.28	HP



All models are ENERGY STAR certified products.

- Item too large to ship via UPS/FedEx. Item shipped common carrier at minimum rates.
- * All pricing reflects the individual item cost. You must order in multiples as indicated.
- ◆ UL listed for use over bathtubs and showers when connected to a GFCI protected branch circuit.

Carton/UPC Directory

1006 - 414204

Model	UPC Code	Std. Carton		Master Carton		Length	Width	Height	Cube
		Pk.	Wt.	Pk.	Wt.				
1006	0 26715 02320 2	—	—	10	20.00	1.48	1.05	0.83	1.28
100HFL	0 26715 18026 4	1	16.90	—	—	1.76	0.87	1.17	1.78
100HL	0 26715 18025 7	1	16.70	—	—	1.75	0.88	1.17	1.80
103023	0 26715 02335 6	1	31.60	—	—	2.48	1.36	1.00	3.37
103123	0 26715 02336 3	1	2.00	—	—	1.87	0.54	0.24	0.24
110RDF	0 26715 14611 6	—	—	4	17.60	1.83	1.03	0.99	1.87
112	0 26715 00405 8	1	14.50	—	—	1.85	0.52	1.24	1.20
114	0 26715 02254 0	1	14.50	—	—	1.85	0.52	1.24	1.20
120	0 26715 00440 9	1	7.30	—	—	1.25	0.92	0.51	0.58
124	0 26715 00441 6	1	7.20	—	—	1.25	0.92	0.51	0.58
128	0 26715 00442 3	1	7.60	—	—	1.25	0.92	0.51	0.58
153001	0 26715 02346 2	1	39.10	—	—	2.87	1.25	1.20	4.30
153004	0 26715 16338 0	1	38.60	—	—	2.88	1.25	1.20	4.31
153023	0 26715 02347 9	1	38.90	—	—	2.88	1.25	1.20	4.31
153601	0 26715 02348 6	1	41.40	—	—	3.38	1.25	1.21	5.10
153604	0 26715 16339 7	1	41.20	—	—	3.35	1.25	1.21	5.06
153623	0 26715 02349 3	1	41.10	—	—	3.35	1.25	1.21	5.06
157	0 26715 08073 1	1	3.00	—	—	1.04	1.06	0.33	0.37
15TCBB	0 26715 18259 6	1	7.10	—	—	1.98	1.05	0.13	0.28
15TCBL	0 26715 18256 5	1	1.95	16	31.20	0.94	0.75	0.10	0.07
15TCOD	0 26715 18257 2	1	0.60	—	—	0.54	0.13	0.56	0.04
15TCTK	0 26715 18258 9	1	2.40	—	—	1.33	0.34	0.33	0.15
161	0 26715 00263 4	1	5.30	—	—	1.15	0.91	0.62	0.64
162	0 26715 00262 7	1	7.35	—	—	1.05	0.92	0.63	0.61
163	0 26715 00261 0	1	7.20	—	—	1.38	0.93	0.62	0.79
164	0 26715 00260 3	1	9.10	—	—	1.38	1.03	0.60	0.85
165FT	0 26715 03035 4	1	6.00	—	—	1.25	0.92	0.51	0.58
1667H	0 26715 02326 4	—	—	6	7.88	1.57	0.68	0.99	1.06
1667HMTL	0 26715 14457 0	—	—	6	7.88	1.57	0.68	0.99	1.06
1670F	0 26715 02327 1	—	—	6	14.63	1.33	1.13	0.92	1.38
1671F	0 26715 02328 8	—	—	6	15.00	1.33	1.13	0.92	1.38
167FT	0 26715 03036 1	1	6.00	—	—	1.25	0.92	0.52	0.59
1688F	0 26715 02329 5	—	—	6	12.75	1.95	0.78	0.83	1.27
1689F	0 26715 02330 1	—	—	6	15.00	1.33	1.13	0.92	1.38
170	0 26715 00443 0	1	7.20	—	—	1.25	0.92	0.51	0.58
171H	0 26715 02262 5	—	—	4	11.00	1.43	1.04	0.84	1.25
174	0 26715 00257 3	1	7.20	—	—	1.24	0.93	0.51	0.58
174F	0 26715 00457 7	1	5.00	—	—	1.25	0.92	0.52	0.59
174FT	0 26715 03038 5	1	5.10	—	—	1.25	0.92	0.51	0.58
178	0 26715 00448 5	1	7.40	—	—	1.25	0.92	0.51	0.58
192	0 26715 10003 3	1	22.00	—	—	1.86	1.53	0.58	1.63
194	0 26715 02265 6	1	22.00	—	—	1.86	1.53	0.58	1.63
198	0 26715 02267 0	1	22.00	—	—	1.86	1.53	0.58	1.63
2677H	0 26715 13914 9	—	—	4	9.80	1.69	0.78	1.07	1.40
2678F	0 26715 13915 6	—	—	4	12.80	1.83	0.99	1.03	1.87
269VL	0 26715 08269 8	1	0.40	—	—	0.40	0.40	0.29	0.05
269WL	0 26715 08268 1	1	0.50	—	—	0.40	0.40	0.30	0.05
273001C	0 26715 05494 7	1	1.40	—	—	3.11	0.23	0.14	0.10
273002C	0 26715 14276 7	1	1.40	—	—	3.07	0.23	0.14	0.10
273003	0 26715 05297 4	1	66.20	—	—	2.83	2.90	0.90	7.39
273023C	0 26715 05497 8	1	1.70	—	—	3.03	0.40	0.36	0.43
273601C	0 26715 05495 4	1	1.50	—	—	3.09	0.23	0.14	0.10
273602C	0 26715 14277 4	1	2.30	—	—	3.11	0.22	0.13	0.09
273603	0 26715 05298 1	1	72.70	—	—	3.33	2.89	0.90	8.67
273623C	0 26715 05496 1	1	2.10	—	—	4.02	0.54	0.34	0.74
277V	0 26715 13191 4	1	0.50	—	—	0.42	0.27	0.30	0.03
283003	0 26715 05408 4	1	37.90	—	—	2.95	2.83	0.91	7.57
283603	0 26715 05409 1	1	43.20	—	—	3.33	2.89	0.92	8.81
326N	7 84891 77015 9	1	1.20	—	—	0.77	0.77	0.45	0.27
330ALM	0 26715 25008 0	1	0.22	20	4.40	0.44	0.30	0.15	0.02
330W	7 84891 99508 8	1	0.23	20	4.60	0.44	0.29	0.15	0.02
331H	0 26715 07181 4	1	30.00	—	—	2.61	0.82	2.33	4.95
332H	0 26715 07182 1	1	32.00	—	—	2.61	0.82	2.33	4.95
332KR	0 26715 12215 8	1	3.30	—	—	2.04	0.92	0.22	0.41
335	0 26715 10996 8	1	38.00	—	—	3.00	1.21	2.19	7.94
336	0 26715 10997 5	1	44.00	—	—	3.00	1.21	2.19	7.94
345SOBK	0 26715 20471 7	1	21.00	—	—	2.59	0.83	2.25	4.86
345SOWW	0 26715 20472 4	1	20.75	—	—	2.60	0.80	2.27	4.72
349BR	0 26715 18983 0	1	19.50	—	—	2.15	0.75	2.21	3.56
35	0 26715 02169 7	1	1.70	—	—	1.02	0.49	0.13	0.06
350BK	0 26715 18270 1	1	16.60	—	—	1.88	0.70	1.92	2.52

Model	UPC Code	Std. Carton		Master Carton		Length	Width	Height	Cube
		Pk.	Wt.	Pk.	Wt.				
350BR	0 26715 18260 2	1	16.40	—	—	1.88	0.70	1.92	2.52
353	0 26715 00153 8	1	11.10	—	—	1.38	1.32	0.73	1.32
35316	0 26715 13697 1	1	13.10	—	—	1.38	1.32	0.73	1.32
355BK	0 26715 18269 5	1	17.80	—	—	1.94	0.71	1.88	2.57
355BR	0 26715 18268 8	1	17.10	—	—	1.94	0.71	1.88	2.57
356BK	0 26715 18267 1	1	20.40	—	—	1.96	0.71	2.00	2.77
356BR	0 26715 18271 8	1	21.00	—	—	1.94	0.77	1.88	2.80
356NDK	0 26715 17423 2	1	5.10	—	—	2.15	0.89	0.93	1.79
357NDK	0 26715 17424 9	1	5.30	—	—	1.71	1.19	1.07	2.17
358	0 26715 00156 9	1	17.80	—	—	1.96	0.71	2.00	2.77
358NDK	0 26715 25624 2	1	5.10	—	—	2.15	0.89	0.93	1.79
359NDK	0 26715 23795 1	1	5.10	—	—	1.71	1.19	1.07	2.17
360ALM	0 26715 25007 3	1	0.27	20	5.40	0.36	0.31	0.24	0.03
360NDK	0 26715 25625 9	1	5.30	—	—	1.71	1.19	1.07	2.17
360W	7 84891 99336 7	1	0.27	20	5.40	0.35	0.31	0.22	0.02
3677H	0 26715 14133 3	—	—	4	13.20	1.69	0.78	1.07	1.40
372	7 84891 77220 7	1	7.00	—	—	0.82	1.47	1.43	1.72
372401	0 26715 03224 2	1	6.80	—	—	2.25	0.64	1.63	2.35
373001	0 26715 03227 3	1	8.30	—	—	2.75	0.64	1.63	2.87
373004	0 26715 04454 2	1	8.80	—	—	2.75	0.63	1.63	2.83
373601	0 26715 03232 7	1	9.70	—	—	3.25	0.64	1.63	3.39
376JL	7 84891 99227 8	1	1.74	6	10.44	0.55	0.55	0.28	0.08
3808	7 84891 99231 5	—	—	8	13.70	8.00	0.67	0.33	1.78
3810	0 26715 23544 5	—	—	10	22.00	10.00	0.71	0.46	3.25
391	7 84891 99240 7	1	0.50	6	3.00	0.73	0.67	0.15	0.07
392	7 84891 77320 4	1	0.97	—	—	0.93	0.33	0.33	0.10
393	7 84891 99242 1	1	0.82	6	4.92	0.50	0.58	0.25	0.07
394	7 84891 99339 8	1	0.10	10	1.00	0.03	0.25	0.32	0.00
395	7 84891 99243 8	1	1.90	6	11.40	2.32	0.33	0.50	0.39
3964	0 26715 23843 9	1	5.20	—	—	0.94	0.69	0.82	0.53
402101	0 26715 03090 3	1	10.10	—	—	2.00	0.64	1.63	2.09
402102	0 26715 14273 6	1	10.10	—	—	2.00	0.64	1.63	2.09
402108	0 26715 03091 0	1	9.30	—	—	2.00	0.64	1.63	2.09
402401	0 26715 02358 5	1	10.90	—	—	2.25	0.64	1.63	2.35
402402	0 26715 14252 1	1	10.10	—	—	2.25	0.64	1.63	2.35
402404	0 26715 02359 2	1	11.40	—	—	2.25	0.64	1.63	2.35
403001	0 26715 01081 3	1	12.10	—	—	2.75	0.63	1.63	2.79
403002	0 26715 14253 8	1	12.10	—	—	2.75	0.64	1.63	2.87
403004	0 26715 01082 0	1	12.60	—	—	2.75	0.62	1.63	2.76
403023	0 26715 03093 4	1	12.10	—	—	2.75	0.63	1.63	2.79
403601	0 26715 01087 5	1	13.50	—	—	3.26	0.64	1.63	3.40
403602	0 26715 14254 5	1	13.50	—	—	3.25	0.64	1.63	3.39
403604	0 26715 01088 2	1	14.00	—	—	3.25	0.64	1.63	3.39
403623	0 26715 03094 1	1	13.50	—	—	3.26	0.64	1.63	3.40
404201	0 26715 03095 8	1	14.80	—	—	3.75	0.64	1.63	3.91
404202	0 26715 14255 2	1	14.80	—	—	3.75	0.64	1.63	3.91
406	0 26715 02064 5	—	—	5	12.19	2.08	0.64	0.63	0.84
407	0 26715 01118 6	—	—	5	10.63	2.09	0.71	0.74	1.10
408	0 26715 22965 9	1	2.20	5	11.00	2.00	0.67	0.67	0.89
410	0 26715 02274 8	—	—	5	20.00	0.85	0.82	2.06	1.43
411	0								

Model	UPC Code	Std. Carton		Master Carton		Length	Width	Height	Cube
		Pk.	Wt.	Pk.	Wt.				
415	0 26715 00796 7	—	—	4	6.50	1.69	1.68	0.68	1.92
418	0 26715 05945 4	1	3.40	—	—	1.13	1.12	0.90	1.14
419	0 26715 01600 6	1	1.10	—	—	0.98	0.77	0.77	0.58
41F	0 26715 00091 3	—	—	6	1.50	0.94	0.41	0.85	0.33
421	0 26715 03900 5	1	0.75	—	—	1.00	0.83	0.13	0.10
422401	0 26715 03110 8	1	10.40	—	—	2.25	0.64	1.63	2.35
422401D	0 26715 17252 8	1	10.40	—	—	2.25	0.64	1.63	2.35
422402	0 26715 14245 3	1	10.40	—	—	2.25	0.64	1.63	2.35
422404	0 26715 03111 5	1	10.70	—	—	2.25	0.64	1.63	2.35
423	0 26715 03902 9	1	3.60	—	—	1.60	0.95	0.95	1.44
423001	0 26715 00226 9	1	11.60	—	—	2.75	0.63	1.63	2.79
423001D	0 26715 17257 3	1	11.60	—	—	2.75	0.63	1.63	2.79
423002	0 26715 14246 0	1	11.60	—	—	2.75	0.64	1.63	2.87
423004	0 26715 00414 0	1	12.10	—	—	2.75	0.64	1.63	2.87
423023	0 26715 03116 0	1	11.60	—	—	2.75	0.63	1.63	2.79
423601	0 26715 00228 3	1	12.90	—	—	3.24	0.65	1.63	3.42
423601D	0 26715 17255 9	1	12.90	—	—	3.24	0.65	1.63	3.42
423602	0 26715 14247 7	1	12.90	—	—	3.24	0.65	1.63	3.42
423604	0 26715 00417 1	1	13.50	—	—	3.25	0.64	1.63	3.39
423608D	0 26715 17254 2	1	12.90	—	—	3.25	0.64	1.63	3.39
423623	0 26715 03117 7	1	12.90	—	—	3.25	0.64	1.63	3.39
424	0 26715 03903 6	1	4.10	—	—	1.61	0.96	0.94	1.45
424201	0 26715 00420 1	1	14.10	—	—	3.75	0.64	1.63	3.91
424201D	0 26715 17256 6	1	12.90	—	—	3.75	0.64	1.63	3.91
424202	0 26715 14292 7	1	14.10	—	—	3.75	0.64	1.63	3.91
424204	0 26715 03584 7	1	14.90	—	—	3.75	0.64	1.63	3.91
427	0 26715 12607 1	1	2.50	—	—	1.65	0.94	0.60	0.93
428	0 26715 01114 8	1	1.30	—	—	1.03	0.49	0.72	0.36
429	0 26715 01115 5	1	2.20	—	—	1.00	1.03	0.88	0.90
430	0 26715 01601 3	1	2.80	—	—	0.98	0.90	0.53	0.47
431	0 26715 01602 0	1	3.60	—	—	1.02	0.88	0.79	0.71
432	0 26715 22966 6	1	1.95	—	—	1.02	1.00	0.85	0.87
433	0 26715 00051 7	1	3.25	—	—	1.74	1.63	0.24	0.69
433004	0 26715 10058 3	1	14.20	—	—	2.78	0.62	1.61	2.75
433011	0 26715 10056 9	1	13.80	—	—	2.75	0.67	1.63	2.98
433022	0 26715 14234 7	1	14.40	—	—	2.76	0.64	1.63	2.89
433023	0 26715 14519 5	1	13.80	—	—	2.77	0.64	1.63	2.88
433604	0 26715 10061 3	1	15.80	—	—	3.26	0.64	1.65	3.44
433611	0 26715 10059 0	1	15.80	—	—	3.28	0.65	1.65	3.50
433622	0 26715 14235 4	1	16.20	—	—	3.27	0.63	1.64	3.40
433623	0 26715 14520 1	1	15.20	—	—	3.26	0.65	1.64	3.48
437	0 26715 03907 4	1	12.00	—	—	2.34	0.83	1.58	3.07
438	0 26715 07549 2	1	1.60	—	—	0.69	0.69	0.69	0.33
441	0 26715 03908 1	1	3.80	—	—	1.18	1.15	0.32	0.43
453	0 26715 04491 7	1	5.20	—	—	2.08	1.00	1.00	2.08
454	0 26715 04492 4	1	5.10	—	—	2.11	1.08	1.06	2.41
459	0 26715 15379 4	1	1.90	—	—	1.28	0.67	0.77	0.65
462401	0 26715 14502 7	1	12.20	—	—	2.25	0.64	1.63	2.35
462404	0 26715 14503 4	1	12.60	—	—	2.25	0.64	1.63	2.35
462423	0 26715 14505 8	1	12.20	—	—	2.25	0.64	1.63	2.35
463001	0 26715 01062 2	1	13.40	—	—	2.75	0.64	1.63	2.87
463002	0 26715 14242 2	1	13.40	—	—	2.75	0.64	1.63	2.87
463004	0 26715 00237 5	1	13.90	—	—	2.75	0.64	1.63	2.87
463008	0 26715 00234 4	1	13.40	—	—	2.75	0.64	1.63	2.87
463011	0 26715 10395 9	1	13.40	—	—	2.75	0.67	1.62	2.96
463023	0 26715 03120 7	1	13.40	—	—	2.75	0.64	1.63	2.87
463601	0 26715 01061 5	1	14.90	—	—	3.25	0.64	1.63	3.39
463602	0 26715 14243 9	1	14.90	—	—	3.25	0.66	1.63	3.48
463604	0 26715 00241 2	1	15.40	—	—	3.25	0.64	1.63	3.39
463623	0 26715 03122 1	1	14.90	—	—	3.25	0.66	1.63	3.48
464201	0 26715 00242 9	1	16.00	—	—	3.75	0.64	1.63	3.91
464202	0 26715 14244 6	1	16.00	—	—	3.75	0.64	1.63	3.91
464204	0 26715 00244 3	1	15.40	—	—	3.75	0.64	1.63	3.91
464208	0 26715 00243 6	1	16.00	—	—	3.75	0.64	1.63	3.91
472	0 26715 02281 6	1	2.60	—	—	0.85	0.84	0.69	0.49
475	0 26715 16541 4	1	0.30	—	—	0.57	0.57	0.38	0.12
475B	0 26715 16540 7	—	—	6	1.13	0.97	0.54	0.56	0.29
502	0 26715 02282 3	1	10.80	—	—	1.46	0.65	1.20	1.14
503	0 26715 02283 0	1	7.90	—	—	1.29	0.54	1.04	0.73
504	0 26715 02284 7	1	8.60	—	—	1.17	0.78	1.17	1.05
505	0 26715 02285 4	1	7.00	—	—	1.14	0.71	1.16	0.94

Model	UPC Code	Std. Carton		Master Carton		Length	Width	Height	Cube
		Pk.	Wt.	Pk.	Wt.				
506	0 26715 02286 1	1	12.60	—	—	1.25	0.79	1.26	1.25
507	0 26715 02287 8	1	11.10	—	—	1.25	0.79	1.26	1.25
508	0 26715 02288 5	1	13.30	—	—	1.63	0.92	1.23	1.82
509	0 26715 02289 2	1	12.70	—	—	1.64	0.92	1.23	1.86
509S	0 26715 02290 8	1	13.00	—	—	1.60	0.90	1.25	1.80
510	0 26715 02291 5	1	10.20	—	—	1.13	0.73	1.17	0.96
511	0 26715 02292 2	1	8.30	—	—	1.13	0.73	1.17	0.96
512	0 26715 02293 9	1	3.20	—	—	0.72	0.70	0.58	0.29
512M	0 26715 06713 8	1	3.40	—	—	0.71	0.71	0.82	0.41
512V	0 26715 03815 2	1	0.30	—	—	0.42	0.27	0.30	0.03
517W	0 26715 03859 6	1	0.30	—	—	0.42	0.27	0.30	0.03
519V	0 26715 03820 6	1	0.40	—	—	0.42	0.25	0.32	0.03
519W	0 26715 03864 0	1	0.40	—	—	0.42	0.25	0.32	0.03
519W	0 26715 03864 0	1	0.40	—	—	0.42	0.25	0.32	0.03
605RP	7 84891 34408 4	1	12.70	—	—	1.59	0.99	0.78	1.24
610FA	0 26715 21105 0	1	2.50	—	—	1.13	1.13	0.90	1.13
611	0 26715 06692 6	1	3.40	—	—	1.35	0.93	1.34	1.69
611CM	0 26715 06693 3	1	4.10	—	—	1.35	0.93	1.33	1.68
612	0 26715 06694 0	1	7.20	—	—	1.77	1.77	1.78	5.54
612CM	0 26715 06695 7	1	7.20	—	—	1.77	1.77	1.76	5.49
613	0 26715 06696 4	1	3.90	—	—	1.33	1.71	1.33	3.04
613004	0 26715 10352 2	1	38.30	—	—	2.68	1.48	1.95	7.72
614804	0 26715 15230 8	1	72.20	—	—	4.38	1.88	2.23	18.36
614804EX	0 26715 15232 2	1	54.00	—	—	4.38	1.88	2.23	18.36
619004	0 26715 10355 3	1	38.10	—	—	3.19	1.49	1.98	9.44
619004EX	0 26715 15231 5	1	38.50	—	—	3.19	1.49	1.98	9.44
61V	0 26715 03825 1	1	0.50	—	—	0.42	0.27	0.30	0.03
61W	0 26715 03869 5	1	0.50	—	—	0.42	0.27	0.30	0.03
61W	0 26715 03825 1	1	0.50	—	—	0.42	0.27	0.30	0.03
61W	0 26715 03869 5	1	0.50	—	—	0.42	0.27	0.30	0.03
62W	0 26715 03872 5	1	0.80	—	—	0.40	0.40	0.29	0.05
634	0 26715 00265 8	1	5.10	—	—	1.60	1.21	0.63	1.21
634M	0 26715 05781 8	1	6.30	—	—	1.63	1.18	0.73	1.38
636	0 26715 00060 9	1	2.00	—	—	0.95	0.81	0.43	0.33
636AL	0 26715 05251 6	1	0.70	—	—	0.94	0.80	0.44	0.33
637004	0 26715 10361 4	1	50.40	—	—	3.40	2.27	2.58	19.92
637004EX	0 26715 15233 9	1	82.00	—	—	3.58	2.63	2.13	19.99
639	0 26715 00264 1	1	2.50	—	—	1.11	0.81	0.53	0.47
63V	0 26715 03829 9	1	0.70	—	—	0.40	0.40	0.29	0.05
63W	0 26715 03873 2	1	0.80	—	—	0.40	0.40	0.30	0.05
641	0 26715 01137 7	1	1.30	—	—	0.79	0.79	0.67	0.42
641FA	0 26715 19206 9	1	1.20	—	—	0.79	0.79	0.67	0.42
642	0 26715 01138 4	—	—	4	3.50	1.13	1.13	0.83	1.06
643	0 26715 02294 6	1	2.40	—	—	1.13	1.13	0.88	1.13
643FA	0 26715 19207 6	1	2.40	—	—	1.13	1.13	0.89	1.14
644	0 26715 00393 8	1	3.20	—	—	1.60	1.21	0.61	1.18
646	0 26715 01605 1	1	0.90	—	—	0.69	0.71	0.70	0.34
647	0 26715 05212 7	1	1.40	—	—	0.79	0.79	0.67	0.42
649	0 26715 00394 5	1	1.40	—	—	1.11	0.81	0.53	0.47
64V	0 26715 04986 8	1	0.50	—	—	0.42	0.25	0.32	0.03
64W	0 26715 15854 6	1	0.50	—	—	0.42	0.25	0.32	0.03
654H	0 26715 02295 3</								

Model	UPC Code	Std. Carton		Master Carton		Length	Width	Height	Cube	Model	UPC Code	Std. Carton		Master Carton		Length	Width	Height	Cube
		Pk.	Wt.	Pk.	Wt.							Pk.	Wt.	Pk.	Wt.				
682	0 26715 00719 6	1	3.50	—	—	0.78	0.43	0.73	0.25	9422P	7 84891 32648 6	1	7.50	—	—	1.37	0.92	0.59	0.74
682NT	7 84891 30168 1	1	3.50	—	—	0.73	0.42	0.79	0.24	9427P	7 84891 32649 3	1	9.00	—	—	1.38	1.04	0.62	0.88
688	0 26715 00251 1	1	3.50	—	—	0.85	0.36	0.79	0.24	961L	0 26715 13188 4	1	2.10	—	—	1.06	1.06	0.18	0.20
689	0 26715 00289 4	1	3.50	—	—	0.85	0.36	0.79	0.24	97	0 26715 03890 9	1	1.60	—	—	0.68	0.68	0.17	0.33
68V	0 26715 03844 2	1	0.90	—	—	0.43	0.27	0.33	0.04	9810WH	7 84891 32811 4	1	9.80	—	—	1.13	0.48	1.43	0.77
68W	0 26715 03885 5	1	0.35	—	—	0.43	0.26	0.31	0.04	9815WH	7 84891 32816 9	1	9.80	—	—	1.44	0.46	1.12	0.74
690	0 26715 16807 1	1	4.80	—	—	0.95	0.43	0.81	0.33	981L	0 26715 12471 8	1	1.60	—	—	1.06	1.05	0.18	0.19
690NT	7 84891 25870 1	1	4.70	—	—	0.94	0.44	0.82	0.34	982L	0 26715 12472 5	1	2.90	—	—	1.84	1.04	0.19	0.37
690RA	7 84891 25450 5	—	—	6	7.88	1.58	0.68	0.99	1.07	983L	0 26715 12473 2	1	3.60	—	—	1.86	1.53	0.18	0.50
690RMTLA	7 84891 25451 2	—	—	6	8.40	1.57	0.68	0.99	1.06	A000HF	0 26715 23611 4	—	—	4	11.30	1.95	0.97	1.07	2.01
695	7 84891 25836 7	1	3.80	—	—	0.85	0.36	0.79	0.24	A000HL	0 26715 23662 6	—	—	4	11.55	1.94	0.96	1.08	2.00
695RB	7 84891 25453 6	—	—	6	15.75	1.32	1.14	1.00	1.50	A110	0 26715 23653 4	1	8.90	—	—	1.11	1.11	0.92	1.13
696	0 26715 02315 8	1	10.30	—	—	1.54	1.01	0.80	1.24	A110F	0 26715 23660 2	—	—	4	23.00	2.03	1.09	1.26	2.78
696N	7 84891 25841 1	1	3.40	—	—	0.85	0.36	0.79	0.24	A110L	0 26715 23533 9	1	9.60	—	—	1.11	1.02	1.11	1.25
696RNB	7 84891 25455 0	—	—	6	12.48	1.95	0.79	0.88	1.35	A50L	0 26715 23648 0	1	9.35	—	—	1.11	1.02	1.11	1.25
69W	0 26715 08225 4	1	0.30	—	—	0.43	0.27	0.33	0.04	A70L	0 26715 23649 7	1	9.50	—	—	1.11	1.02	1.11	1.25
71V	0 26715 03852 7	1	1.00	—	—	0.42	0.27	0.30	0.03	A70LF	0 26715 23656 5	—	—	4	26.50	2.21	1.04	1.75	4.03
72V	0 26715 03855 8	1	0.50	—	—	0.42	0.27	0.30	0.03	A80	0 26715 23651 0	1	8.75	—	—	1.11	0.92	1.11	1.13
72W	0 26715 05375 9	1	0.50	—	—	0.42	0.27	0.30	0.03	A80F	0 26715 23652 7	—	—	4	22.00	2.03	1.09	1.26	2.78
72V	0 26715 03855 8	1	0.50	—	—	0.42	0.27	0.30	0.03	A80HD	0 26715 23652 7	1	9.45	—	—	1.11	0.92	1.11	1.13
72W	0 26715 05375 9	1	0.50	—	—	0.42	0.27	0.30	0.03	A80HDF	0 26715 23658 9	—	—	4	25.00	2.03	1.09	1.26	2.78
73	0 26715 01606 8	1	0.70	—	—	0.73	0.28	0.28	0.06	A80L	0 26715 23531 5	1	9.61	—	—	1.10	1.10	1.04	1.27
741SN	0 26715 14509 6	1	10.90	—	—	1.18	1.18	1.14	1.58	ACCGSEF2	0 26715 15658 0	1	0.20	—	—	0.75	0.39	0.15	0.04
744	0 26715 16301 4	1	9.40	—	—	1.20	0.79	0.88	0.83	ACCGSFF2	0 26715 15255 1	1	0.20	—	—	0.77	0.40	0.15	0.05
744LED	0 26715 20915 6	1	10.30	—	—	1.23	0.79	0.92	0.89	ACCGSFH	0 26715 15253 7	1	2.90	—	—	1.69	1.62	0.20	0.55
744LEDNT	0 26715 20916 3	1	10.30	—	—	1.23	0.81	0.91	0.90	ACCGSFHP10	0 26715 15260 5	1	33.90	—	—	2.21	1.77	1.70	6.63
744NT	7 84891 95124 4	1	9.60	—	—	1.23	0.81	0.91	0.90	ACCGSFHP2	0 26715 15254 4	1	3.20	—	—	1.69	1.62	0.21	0.57
750	0 26715 14867 7	1	11.80	—	—	1.39	0.83	1.38	1.60	ACCGSFP2	0 26715 15252 0	1	0.91	—	—	1.67	1.31	0.06	0.14
751	0 26715 14868 4	1	12.00	—	—	1.40	0.82	1.38	1.58	ACCGSFP20	0 26715 15259 9	1	10.10	—	—	1.75	1.38	0.62	1.48
754RB	0 26715 16735 7	1	11.80	—	—	1.18	1.16	1.27	1.72	ACCGSUHD	0 26715 15257 5	1	2.00	—	—	0.96	0.81	0.88	0.68
75V	0 26715 03832 9	1	0.50	—	—	0.42	0.25	0.32	0.03	AE110	0 26715 23529 2	1	8.80	—	—	1.11	0.92	1.11	1.13
761BN	0 26715 19152 9	1	11.60	—	—	1.23	1.23	1.20	1.80	AE110F	0 26715 23607 7	—	—	4	23.00	2.03	1.09	1.26	2.78
761RB	0 26715 19153 6	1	11.80	—	—	1.23	1.22	1.20	1.79	AE110L	0 26715 23666 4	1	9.00	—	—	1.11	0.92	1.11	1.13
761WHA	0 26715 20106 8	1	12.80	—	—	1.23	1.22	1.20	1.79	AE110LF	0 26715 24188 0	—	—	4	24.00	2.03	1.09	1.26	2.78
763	0 26715 23517 9	1	5.90	—	—	0.79	0.98	1.08	0.84	AE110S	0 26715 24928 2	1	9.50	—	—	1.11	0.92	1.11	1.13
763F	0 26715 23686 2	—	—	4	13.60	1.83	1.03	1.05	1.98	AE110SL	0 26715 24929 9	1	9.80	—	—	1.11	0.92	1.11	1.13
763H	0 26715 23685 5	—	—	4	9.80	1.69	0.78	1.07	1.40	AE50	0 26715 23646 6	1	8.60	—	—	1.11	1.11	0.92	1.13
765HFL	0 26715 18028 8	1	17.30	—	—	1.76	0.88	1.18	1.82	AE50F	0 26715 23655 8	—	—	4	22.00	2.03	1.09	1.26	2.78
765HL	0 26715 18027 1	1	16.80	—	—	1.75	0.87	1.17	1.77	AE60	0 26715 10573 1	1	31.60	—	—	2.19	1.10	1.39	3.36
77DV	0 26715 10631 8	1	0.90	—	—	0.43	0.26	0.33	0.04	AE80	0 26715 23527 8	1	8.75	—	—	1.11	1.11	0.92	1.13
77DW	0 26715 10630 1	1	0.90	—	—	0.43	0.26	0.33	0.04	AE80B	0 26715 23600 8	1	8.75	—	—	1.11	1.11	0.92	1.13
77DV	0 26715 10631 8	1	0.90	—	—	0.43	0.26	0.33	0.04	AE80BF	0 26715 23609 1	—	—	4	23.00	2.03	1.09	1.26	2.78
77DW	0 26715 10630 1	1	0.90	—	—	0.43	0.26	0.33	0.04	AE80BL	0 26715 23957 3	1	9.20	—	—	1.11	0.92	1.11	1.13
77DV	0 26715 10631 8	1	0.90	—	—	0.43	0.26	0.33	0.04	AE80BLF	0 26715 23958 0	—	—	4	24.00	2.03	1.09	1.26	2.78
791LEDM	0 26715 23955 9	1	9.90	—	—	1.24	0.90	1.25	1.40	AE80F	0 26715 23605 3	—	—	4	22.00	2.03	1.09	1.26	2.78
804DD	7 84891 27013 0	1	0.20	24	4.80	0.33	0.33	0.13	0.01	AE80L	0 26715 23664 0	1	9.00	—	—	1.13	1.10	0.92	1.13
804DU	7 84891 27039 0	1	6.20	—	—	0.69	0.68	2.58	1.21	AE80LF	0 26715 23668 8	—	—	4	24.00	2.03	1.09	1.26	2.78
80L	0 26715 17226 9	1	0.40	—	—	0.45	0.23	0.27	0.03	AE80S	0 26715 24926 8	1	9.40	—	—	1.11	0.92	1.11	1.13
80RDF	0 26715 14612 3	—	—	4	17.60	1.83	1.03	1.06	2.00	AE80SL	0 26715 24927 5	1	9.70	—	—	1.11	0.92	1.11	1.13
8210	7 84891 21210 9	1	6.30	—	—	0.95	0.94	0.73	0.66	AE60302SS	0 26715 18645 7	1	12.30	—	—	3.72	2.26	0.42	3.50
82W	0 26715 23034 1	1	0.32	—	—	0.37	0.18	0.19	0.01	AE60362SS	0 26715 18646 4	1	11.90	—	—	3.70	2.26	0.42	3.48
83	0 26715 02241 0	1	0.30	—	—	0.43	0.25	0.31	0.03	AE60422SS	0 26715 18647 1	1	13.90	—	—	4.67	2.25	0.42	4.37
8310	7 84891 21310 6	1	7.70	—	—	1.25	0.63	1.03	0.82	AE60482SS	0 26715 18648 8	1	14.00	—	—	4.67	2.25	0.42	4.37
834	7 84891 99161 5	1	0.20	6	1.20	0.88	0.88	0.06	0.04	AEEP18SS	0 26715 20409 0	1	16.45	—	—	2.38	1.38	1.90	6.24
84	0 26715 02243 4	1	2.80	—	—	1.13	0.89	0.40	0.40	AEEP18SSE	0 26715 20412 0	1	14.60	—	—	2.38	1.63	1.88	7.24
843BL	0 26715 16460 8	1	2.90	—	—	0.79	0.79	0.67	0.42	AEEP2445SS	0 26715 22743 3	1	35.80	—	—	2.38	1.40	2.90	9.64
85	0 26715 02244 1	1	5.40	—	—	1.90	1.56	0.39	1.16	AEEP2445SSE	0 26715 22744 0	1	33.00	—	—	2.04	1.40	2.17	6.17
854	7 84891 99282 7	—	—	6	2.52	1.13	1.08	0.33	0.40	AEEP30SS	0 26715 20410 6	1	24.00	—	—	2.38	1.40	2.88	9.56
8663RP	7 84891 21615 2	1	11.70	—	—	1.40	0.83	1.40	1.62	AEEP30SSE	0 26715 20413 7	1	22.30	—	—	2.38	1.63	2.89	11.22
8664RP	7 84891 21625 1	1	11.70	—	—	1.38	0.81	1.38	1.54	AEEP6SS	0 26715 20408 3	1	5.60	—	—	2.38	1.38	0.90	2.94
877	7 84891 27570 8	1	1.30	—	—	0.90	0.67	0.73	0.44	AEEP6SSE	0 26715 20411 3	1	6.00	—	—	2.38	1.62	0.92	3.52
87W	0 26715 25037 0	1	0.20	50	10.00	0.28	0.24	0.40	0.03	AEN110	0 26715 23530 8	1	8.80	—	—	1.11	0.92	1.11	1.13
885AL	7 84891 99706 8	—	—	6	4.80	1.55	0.63	1.09	1.06	AEN110F	0 26715 23608 4	—	—	4	23.00	2.03	1.09	1.26	2.78
885BL	7 84891 27649 1	—	—	6	9.60	1.55	0.63	1.09	1.06	A									

Model	UPC Code	Std. Carton		Master Carton		Length	Width	Height	Cube	Model	UPC Code	Std. Carton		Master Carton		Length	Width	Height	Cube
		Pk.	Wt.	Pk.	Wt.							Pk.	Wt.	Pk.	Wt.				
AEN80F	0 26715 23606 0	—	—	4	22.00	2.03	1.09	1.26	2.78	BCDJ142SS	0 26715 24058 6	1	38.00	—	—	3.92	0.67	1.98	5.16
AEN80L	0 26715 23665 7	1	9.10	—	—	1.11	0.92	1.11	1.13	BCDJ142WH	0 26715 24087 6	1	38.00	—	—	3.92	0.67	1.98	5.16
AEN80LF	0 26715 23669 5	—	—	4	24.00	2.03	1.09	1.26	2.78	BCR1	0 26715 19291 5	1	0.20	—	—	0.44	0.28	0.13	0.02
AN000HF	0 26715 23612 1	—	—	4	11.30	1.95	0.97	1.07	2.01	BCSD124BL	0 26715 24064 7	1	18.00	—	—	2.40	0.67	1.97	3.15
AN000HL	0 26715 23663 3	—	—	4	11.55	1.95	0.97	1.08	2.03	BCSD124SS	0 26715 24065 4	1	18.00	—	—	2.40	0.67	1.97	3.15
AN110	0 26715 23654 1	1	8.90	—	—	1.11	0.92	1.11	1.13	BCSD124WWW	0 26715 24066 1	1	18.00	—	—	2.40	0.67	1.97	3.15
AN110F	0 26715 23661 9	—	—	4	23.00	2.03	1.09	1.26	2.78	BCSD130BC	0 26715 24067 8	1	21.00	—	—	2.90	0.66	1.96	3.73
AN110L	0 26715 23534 6	1	9.61	—	—	1.10	1.10	1.04	1.27	BCSD130BL	0 26715 24068 5	1	21.00	—	—	2.90	0.66	1.96	3.73
AN70L	0 26715 23650 3	1	9.61	—	—	1.10	1.10	1.04	1.27	BCSD130SS	0 26715 24069 2	1	21.00	—	—	2.90	0.66	1.96	3.73
AN70LF	0 26715 23684 8	—	—	4	26.50	2.21	1.04	1.75	4.03	BCSD130WWW	0 26715 24070 8	1	21.00	—	—	2.90	0.66	1.96	3.73
AN80HDF	0 26715 23659 6	—	—	4	25.00	2.22	1.04	1.25	2.89	BCSD136BC	0 26715 24071 5	1	22.70	—	—	3.40	0.67	1.96	4.43
AN80L	0 26715 23532 2	1	9.60	—	—	1.11	1.02	1.11	1.25	BCSD136BL	0 26715 24072 2	1	22.70	—	—	3.40	0.67	1.96	4.43
ANKE60302SS	0 26715 18641 9	1	12.00	—	—	3.68	2.27	0.42	3.48	BCSD136SS	0 26715 24073 9	1	22.70	—	—	3.40	0.67	1.96	4.43
ANKE60362SS	0 26715 18642 6	1	12.50	—	—	3.68	2.27	0.43	3.55	BCSD136WWW	0 26715 24074 6	1	22.70	—	—	3.40	0.67	1.96	4.43
ANKE60422SS	0 26715 18643 3	1	16.50	—	—	4.67	2.25	0.42	4.37	BCSD142BL	0 26715 24075 3	1	25.00	—	—	3.88	0.65	1.98	4.99
ANKE60482SS	0 26715 18644 0	1	16.80	—	—	4.67	2.25	0.42	4.37	BCSD142SS	0 26715 24076 0	1	25.00	—	—	3.88	0.65	1.98	4.99
ARP310	0 26715 18222 0	—	—	5	1.25	0.68	0.52	0.40	0.14	BCSD142WWW	0 26715 24077 7	1	25.00	—	—	3.88	0.65	1.98	4.99
ARP6	0 26715 18224 4	—	—	5	1.88	0.68	0.51	0.39	0.13	BCSEK130BL	0 26715 24078 4	1	21.20	—	—	2.90	0.67	1.96	3.78
AWEPD36SS	0 26715 20414 4	1	16.00	—	—	3.29	1.79	0.38	2.21	BCSEK130SL	0 26715 24187 3	1	21.00	—	—	2.92	0.65	1.96	3.69
AWEPD42SS	0 26715 25538 2	1	18.20	—	—	3.80	1.78	0.38	2.57	BCSEK130SS	0 26715 24079 1	1	20.78	—	—	2.88	0.65	1.96	3.66
AWEPD48SS	0 26715 20415 1	1	19.00	—	—	4.29	1.78	0.38	2.86	BCSEK130WWW	0 26715 24080 7	1	21.00	—	—	2.90	0.66	1.96	3.73
AWEPD60SS	0 26715 24006 7	1	22.60	—	—	5.36	1.78	0.38	3.57	BD4	0 26715 06778 7	1	2.20	—	—	1.00	0.86	0.72	0.62
B12LCDARNW	0 26715 24298 6	1	269.00	—	—	3.15	3.67	2.50	28.84	BD6	0 26715 05776 4	1	3.20	—	—	1.52	0.77	0.79	0.92
B12LCDASNW	0 26715 24296 2	1	279.00	—	—	4.38	3.54	2.31	35.83	BK105	7 84891 03001 7	—	—	24	27.00	1.77	1.13	0.84	1.67
B12LCDHRNW	0 26715 25314 2	1	276.00	—	—	4.38	3.54	2.38	36.80	BK110NBWH	7 84891 03003 1	—	—	24	48.00	1.08	1.07	1.79	2.07
B12LCDHSNW	0 26715 25313 5	1	282.00	—	—	4.38	3.54	2.38	36.80	BK115LWH	7 84891 03005 5	—	—	24	48.00	1.12	1.06	1.76	2.08
B12LCDPRNC	0 26715 24308 2	1	268.00	—	—	4.38	3.54	2.29	35.51	BK120NBWH	7 84891 03004 8	—	—	24	48.00	1.08	1.07	1.79	2.07
B12LCDPRNW	0 26715 24297 9	1	276.00	—	—	4.71	3.50	2.29	37.76	BK125LWH	7 84891 03006 2	—	—	24	48.00	1.07	1.07	1.75	1.99
B12LCDPSNC	0 26715 24307 5	1	264.00	—	—	4.38	3.54	2.29	35.51	BK131LPB	7 84891 03009 3	—	—	24	48.00	1.77	1.08	1.12	2.12
B12LCDPSNW	0 26715 24295 5	1	265.00	—	—	4.38	3.54	2.29	35.51	BK131LRBZ	7 84891 03012 3	—	—	6	12.37	1.04	0.61	0.89	0.57
B12LCEARNW	0 26715 24290 0	1	247.00	—	—	3.15	3.67	2.50	28.84	BK131LSN	7 84891 03011 6	—	—	6	12.37	1.05	0.63	0.92	0.60
B12LCEASNW	0 26715 24288 7	1	208.00	—	—	3.48	3.08	2.35	25.25	BK144LCL	7 84891 03002 4	—	—	24	48.00	1.09	1.07	1.83	2.13
B12LCEHRNW	0 26715 25312 8	1	215.00	—	—	3.50	3.08	2.38	25.63	BK147LWH	7 84891 03016 1	—	—	24	64.70	1.93	1.21	1.19	2.78
B12LCEHSNW	0 26715 25311 1	1	210.00	—	—	3.50	3.08	2.38	25.63	BK240LWH	0 26715 25503 0	—	—	24	48.00	1.57	0.89	1.34	1.87
B12LCEPRNC	0 26715 24304 4	1	269.00	—	—	3.15	3.67	2.50	28.84	BK240SLPB	0 26715 25504 7	—	—	24	45.60	1.56	0.88	1.33	1.82
B12LCEPRNW	0 26715 24289 4	1	205.00	—	—	3.50	3.10	2.36	25.62	BK240SLSN	0 26715 25505 5	—	—	24	45.60	1.56	0.88	1.33	1.82
B12LCEPSNC	0 26715 24303 7	1	269.00	—	—	3.15	3.67	2.50	28.84	BK242LWH	0 26715 25505 4	—	—	24	49.20	1.57	0.89	1.34	1.87
B12LCEPSNW	0 26715 24287 0	1	206.00	—	—	3.50	3.07	2.33	25.04	BKDB130BL	0 26715 24385 3	1	22.00	—	—	2.88	0.66	1.96	3.72
B1600705	0 26715 24311 2	1	241.00	—	—	4.50	2.17	3.50	34.12	BKDB130SS	0 26715 24386 0	1	22.00	—	—	2.88	0.66	1.96	3.72
B5330SS	0 26715 21088 6	1	44.00	—	—	2.83	1.48	2.25	9.43	BKDB130WWW	0 26715 24387 7	1	22.00	—	—	2.88	0.66	1.96	3.72
B5336SS	0 26715 21089 3	1	48.00	—	—	3.31	1.48	2.25	11.02	BKDB136BL	0 26715 24388 4	1	24.00	—	—	3.38	0.65	1.96	4.31
B5630SS	0 26715 18712 6	1	47.10	—	—	3.12	1.48	1.85	8.55	BKDB136SS	0 26715 24389 1	1	24.00	—	—	3.39	0.74	1.96	4.93
B5636SS	0 26715 18711 9	1	50.60	—	—	3.14	1.50	1.84	8.68	BKDB136WWW	0 26715 24390 7	1	24.00	—	—	3.38	0.65	1.96	4.31
B5730SS	0 26715 18714 0	1	40.10	—	—	3.13	1.48	1.84	8.56	BKDEG130BL	0 26715 24396 9	1	23.65	—	—	2.90	0.66	1.97	3.75
B5736SS	0 26715 18713 3	1	42.40	—	—	3.12	1.51	1.85	8.70	BKDEG130SS	0 26715 24397 6	1	22.90	—	—	2.89	0.67	1.97	3.79
B5830SS	0 26715 18716 4	1	33.80	—	—	2.72	1.31	1.92	6.83	BKDEG130WWW	0 26715 24398 3	1	23.00	—	—	2.90	0.67	1.97	3.80
B5836SS	0 26715 18715 7	1	36.90	—	—	3.19	1.31	1.89	7.92	BKSA130BL	0 26715 24408 9	1	20.50	—	—	2.88	0.67	1.97	3.78
B5936SS	0 26715 18710 2	1	69.50	—	—	3.09	1.31	2.13	8.62	BKSA130SS	0 26715 24409 6	1	20.05	—	—	2.88	0.66	1.96	3.73
B6LCDARN	0 26715 24282 5	1	231.00	—	—	3.33	2.63	2.50	21.87	BKSA130WWW	0 26715 24410 2	1	20.50	—	—	2.88	0.67	1.97	3.78
B6LCDASN	0 26715 24280 1	1	231.00	—	—	3.33	2.63	2.50	21.87	BKSH130BL	0 26715 24413 3	1	20.85	—	—	2.94	0.67	1.96	3.84
B6LCDHRN	0 26715 25310 4	1	208.00	—	—	4.54	2.46	2.38	26.52	BKSH130SS	0 26715 24414 0	1	20.65	—	—	2.91	0.68	1.96	3.89
B6LCDPRN	0 26715 24281 8	1	200.00	—	—	2.42	4.52	2.33	25.47	BKSH130WWW	0 26715 24415 7	1	20.85	—	—	2.94	0.67	1.96	3.84
B6LCDPSN	0 26715 24279 5	1	197.00	—	—	2.42	4.52	2.31	25.22	BNDF130BL	0 26715 25216 9	1	22.25	—	—	2.92	0.61	2.05	3.64
B6LCEARN	0 26715 24274 0	1	197.00	—	—	3.33	2.63	2.50	21.87	BNDF130SS	0 26715 25217 6	1	22.60	—	—	2.90	0.61	2.04	3.60
B6LCEASN	0 26715 24272 6	1	197.00	—	—	3.33	2.63	2.50	21.87	BNDF130WWW	0 26715 25218 3	1	22.25	—	—	2.92	0.61	2.05	3.64
B6LCEHRN	0 26715 25309 8	1	165.00	—	—	3.08	2.50	2.38	18.31	BNDF136BL	0 26715 25269 5	1	24.49	—	—	3.38	0.60	2.03	4.13
B6LCEHSN	0 26715 25308 1	1	154.00	—	—	3.08	2.50	2.38	18.31	BNDF136SS	0 26715 25270 1	1	24.80	—	—	3.40	0.61	2.03	4.21
B6LCEPRN	0 26715 24273 3	1	148.00	—	—	3.06	2.40	2.35	17.27	BNDF136WWW	0 26715 25271 8	1	24.49	—	—	3.38	0.60	2.03	4.13
B6LCEPSN	0 26715 24271 9	1	154.00	—	—	3.06	2.38	2.35	17.18	BNDF142SS	0 26715 25272 5	1	27.00	—	—	3.92	0.61	2.05	4.88
BCDF130BLS	0 26715 25303 6	1	21.00	—	—	2.88	0.63	2.04	3.73	BNSC130BL	0 26715 25219 0	1	20.10	—	—	2.92	0.61	2.05	3.64
BCDF130SS	0 26715 24050 0	1	23.00	—	—	2.88	0.66	1.95	3.70	BNSC130SS	0 26715 25220 6	1	20.63	—	—	2.88	0.60	2.06	3.58
BCDF136BLS	0 26715 25304 3	1	25.00	—	—	3.37	0.63	2.04	4.35	BNSC130WWW	0 26715 25221 3	1	20.10	—	—				

Model	UPC Code	Std. Carton		Master Carton		Length	Width	Height	Cube	Model	UPC Code	Std. Carton		Master Carton		Length	Width	Height	Cube
		Pk.	Wt.	Pk.	Wt.							Pk.	Wt.	Pk.	Wt.				
BP2	0 26715 02402 5	—	—	12	4.50	1.51	0.56	1.02	0.86	C370BN	0 26715 17884 1	1	2.35	—	—	0.77	0.29	0.63	0.14
BP20	0 26715 04060 5	—	—	6	2.63	0.95	0.56	0.93	0.49	C905	0 26715 02482 7	—	—	6	5.63	0.77	0.28	0.42	0.09
BP24	0 26715 04485 6	—	—	15	6.56	0.96	0.56	0.93	0.49	C907	0 26715 07128 9	—	—	6	12.00	0.77	0.34	0.46	0.12
BP25	0 26715 04486 3	—	—	6	2.25	0.81	0.73	0.54	0.32	C909	0 26715 07129 6	—	—	6	7.20	0.76	0.29	0.42	0.09
BP27	0 26715 04488 7	—	—	6	8.25	1.10	0.58	1.01	0.65	C915	7 84891 07130 0	—	—	6	6.00	0.72	0.38	0.50	0.13
BP28	0 26715 04489 4	—	—	6	11.63	1.09	0.59	1.01	0.65	CA130	7 84891 98190 6	1	1.20	12	14.40	1.98	0.27	0.27	0.14
BP29	0 26715 04988 2	—	—	6	1.13	1.03	0.82	0.22	0.18	CF329	7 84891 77411 9	1	0.20	20	4.00	0.39	0.34	0.10	0.01
BP33	0 26715 05438 7	—	—	6	2.88	0.94	0.56	0.93	0.49	CF361	7 84891 77412 6	1	0.20	20	4.00	0.46	0.23	0.15	0.02
BP34	0 26715 05438 1	—	—	6	2.63	0.94	0.56	0.93	0.49	CF361F	7 84891 77426 3	1	0.30	20	6.00	0.44	0.21	0.12	0.01
BP35	0 26715 05440 4	—	—	12	7.50	1.03	0.84	1.02	0.88	CF362	7 84891 77413 3	1	0.10	20	2.00	0.25	0.19	0.25	0.01
BP36	0 26715 05442 8	—	—	5	1.88	0.82	0.73	0.55	0.33	CF367	7 84891 77418 8	—	—	6	6.90	3.07	0.45	0.68	0.94
BP38	0 26715 05446 6	—	—	10	5.00	0.94	0.55	0.92	0.47	CF368	7 84891 77419 5	1	0.10	20	2.00	0.39	0.25	0.20	0.02
BP4	0 26715 03135 1	—	—	12	2.25	0.94	0.93	0.71	0.62	CF369	7 84891 77429 4	1	0.10	20	2.00	0.18	0.21	0.27	0.01
BP43	0 26715 04990 5	—	—	12	2.25	1.13	0.76	1.08	0.92	CF372	0 26715 23014 3	1	0.15	25	3.75	0.21	0.25	0.17	0.01
BP436	0 26715 23500 1	—	—	6	1.30	1.23	0.92	0.50	0.57	CF377	7 84891 77431 7	1	0.22	20	4.40	0.36	0.36	0.19	0.02
BP46	0 26715 07167 8	—	—	12	3.75	0.94	0.55	0.93	0.48	CF380	7 84891 77258 0	1	0.04	20	0.80	0.30	0.19	0.06	0.00
BP5	0 26715 03136 8	—	—	4	1.00	1.03	0.82	0.22	0.18	CF382	7 84891 77433 1	1	0.15	20	3.00	0.29	0.29	0.19	0.02
BP50	0 26715 07997 1	—	—	6	9.00	1.08	0.58	1.02	0.64	CF382S	7 84891 77434 8	1	0.11	10	1.10	0.24	0.24	0.19	0.01
BP51	0 26715 07998 8	—	—	6	11.63	1.08	0.60	1.03	0.67	CF383	7 84891 77422 5	1	0.22	20	4.40	0.39	0.37	0.19	0.03
BP52	0 26715 07999 5	—	—	4	8.50	1.13	0.76	1.10	0.95	CF384	7 84891 77438 6	1	0.23	10	2.30	0.46	0.32	0.19	0.03
BP55	0 26715 08259 9	—	—	8	1.50	1.06	0.39	0.82	0.34	CF385	7 84891 77440 9	1	0.09	20	1.80	0.24	0.19	0.23	0.01
BP56	0 26715 08260 5	—	—	8	1.50	0.94	0.39	0.85	0.31	CF387	7 84891 77444 7	1	0.19	10	1.90	0.38	0.35	0.19	0.02
BP57	0 26715 10749 0	—	—	8	3.00	1.24	0.55	1.05	0.72	CF388	7 84891 77446 1	1	0.05	—	—	0.18	0.18	0.13	0.00
BP58	0 26715 10750 6	—	—	8	1.50	0.96	0.56	0.92	0.49	CF389	7 84891 77448 5	1	0.01	10	0.10	0.30	0.19	0.06	0.00
BP7	0 26715 03138 2	—	—	8	2.00	1.10	0.41	0.98	0.44	CF3918	7 84891 77449 2	1	0.55	6	3.30	0.85	0.67	0.10	0.06
BP87Q	0 26715 20177 8	—	—	3	1.35	0.82	0.73	0.33	0.19	CFT12WH	7 84891 20551 4	1	0.40	6	2.40	0.40	0.25	0.18	0.02
BP90	0 26715 16744 9	—	—	4	1.50	0.85	0.84	0.20	0.14	CH230L	7 84891 77924 4	1	9.50	—	—	0.83	1.49	1.49	1.85
BP91	0 26715 19975 4	—	—	4	3.25	1.08	0.58	1.01	0.64	CH235	7 84891 77925 1	1	7.80	—	—	0.83	1.47	1.46	1.78
BPAPFA	0 26715 17857 5	—	—	3	1.88	1.04	1.04	0.23	0.25	CH515	7 84891 77926 8	1	8.60	—	—	0.83	1.43	1.46	1.72
BPDP130SS	0 26715 24789 9	1	38.00	—	—	2.90	0.94	1.94	5.30	CH615	7 84891 77927 5	1	8.30	—	—	0.84	1.45	1.46	1.78
BPDP136SS	0 26715 24790 5	1	41.00	—	—	3.40	0.95	1.94	6.26	CI3303RK	7 84891 77182 8	1	6.20	—	—	0.94	0.71	0.83	0.55
BPDP142SS	0 26715 24791 2	1	45.00	—	—	3.89	0.94	1.94	7.12	CI358W	7 84891 77151 4	—	—	10	6.88	1.64	0.92	0.40	0.60
BPDP148SS	0 26715 24792 9	1	49.00	—	—	4.42	0.95	1.94	8.15	CI376W	0 26715 25580 1	1	0.10	25	2.50	0.96	0.42	0.02	0.01
BPPF30	0 26715 17725 7	—	—	6	3.00	1.40	1.04	0.43	0.62	CI377W	0 26715 25579 5	1	10.20	16	163.20	0.78	0.24	0.37	0.07
BPPF36	0 26715 17726 4	—	—	3	2.04	1.42	1.30	0.23	0.43	CI399ALM	0 26715 25123 0	1	0.25	32	8.00	0.44	0.30	0.16	0.02
BPPF42	0 26715 19420 9	1	1.00	—	—	1.46	1.20	0.11	0.19	CI399EB	0 26715 25122 3	1	0.05	200	10.00	0.18	0.10	0.07	0.00
BPPFA30	0 26715 17727 1	—	—	3	3.38	1.44	0.26	1.08	0.40	CI399RK	0 26715 25121 6	1	0.25	25	6.25	0.57	0.40	0.13	0.03
BPPFA36	0 26715 17729 5	—	—	3	3.94	1.44	0.26	1.28	0.48	CI399W	0 26715 25120 9	1	0.25	32	8.00	0.44	0.30	0.16	0.02
BPODE30	0 26715 18227 5	—	—	3	3.75	1.26	1.25	0.34	0.54	CK135	7 84891 98352 8	1	1.13	25	28.25	2.13	0.38	0.13	0.10
BPOTAF	0 26715 13384 0	—	—	4	1.30	1.12	1.00	0.22	0.24	CS100	0 26715 23613 8	1	8.45	—	—	2.00	1.32	0.83	2.17
BPOTF	0 26715 13383 3	—	—	4	1.50	1.12	1.00	0.22	0.24	CS200	0 26715 23614 5	1	3.95	—	—	2.20	0.86	0.32	0.61
BPRPFA	0 26715 17733 2	—	—	3	1.69	1.06	1.04	0.23	0.26	CS300	0 26715 23615 2	1	17.00	—	—	1.54	1.21	2.67	4.97
BPS1FA30	0 26715 13816 6	—	—	3	2.10	1.06	0.28	1.27	0.37	CS400	0 26715 23616 9	1	19.10	—	—	1.54	1.21	2.67	4.97
BPS1FA36	0 26715 13817 3	—	—	3	2.25	1.53	0.29	1.06	0.47	CS500	0 26715 23617 6	1	25.65	—	—	1.54	1.21	2.67	4.97
BPS2FA30	0 26715 13818 0	—	—	6	4.80	1.40	0.31	1.26	0.54	CS600	0 26715 23618 3	1	25.20	—	—	1.54	1.21	2.67	4.97
BPSF30	0 26715 13813 5	—	—	4	1.88	1.41	0.29	1.25	0.51	CT105	0 26715 23634 3	1	0.12	50	6.00	0.47	0.25	0.21	0.02
BPSF36	0 26715 13814 2	—	—	4	2.25	1.53	1.05	0.28	0.44	CT106G	7 84891 77031 9	1	0.19	50	9.50	0.69	0.38	0.18	0.05
BQDD130BL	0 26715 24920 6	1	24.00	—	—	2.90	0.60	2.13	3.72	CT109	0 26715 23632 9	1	0.15	50	7.50	0.47	0.25	0.19	0.02
BQDD130BLS	0 26715 25305 0	1	24.00	—	—	2.90	0.60	2.13	3.72	CT110	0 26715 23633 6	1	0.19	50	9.50	1.15	0.13	0.13	0.02
BQDD130SS	0 26715 24921 3	1	24.00	—	—	2.90	0.60	2.13	3.72	CT112	7 84891 77033 3	1	0.95	25	23.75	1.52	0.50	0.11	0.08
BQDD130WW	0 26715 24922 0	1	24.00	—	—	2.90	0.60	2.13	3.72	CT140G	7 84891 98353 5	1	1.45	12	17.40	0.94	0.79	0.26	0.19
BQDD136BL	0 26715 24923 7	1	24.00	0	0.00	3.42	0.60	2.15	4.40	CT143B	7 84891 77034 0	1	0.40	30	12.00	0.83	0.22	0.17	0.03
BQDD136BLS	0 26715 25306 7	1	24.00	—	—	3.42	0.60	2.15	4.40	CT150B	7 84891 98354 2	1	0.94	12	11.28	1.08	0.77	0.25	0.21
BQDD136SS	0 26715 24924 4	1	26.00	—	—	3.42	0.60	2.15	4.40	CT156B	7 84891 77971 8	1	0.75	12	9.00	1.02	0.26	0.60	0.16
BQDD136WW	0 26715 24964 0	1	24.00	—	—	3.42	0.60	2.15	4.40	CT157B	7 84891 77972 5	1	0.90	12	10.80	1.22	0.30	0.58	0.21
BOLA130BL	0 26715 24965 7	1	36.00	—	—	3.21	0.60	2.13	4.12	CT158	0 26715 23635 0	1	0.64	21	13.44	1.07	0.46	0.29	0.14
BOLA130SS	0 26715 24966 4	1	37.00	—	—	3.21	0.60	2.13	4.12	CT170	0 26715 19316 5	1	2.10	20	42.00	2.29	0.29	0.25	0.17
BOLA130WH	0 26715 24967 1	1	36.00	—	—	3.21	0.60	2.13	4.12	CT175	0 26715 19317 2	1	1.80	20	36.00	2.33	0.29	0.25	0.17
BOLA136BL	0 26715 25288 6	1	39.00	—	—	3.71	0.58	2.10	4.55	CT350B	7 84891 77976 3	1	2.00	12	24.00	1.04	0.33	0.92	0.32
BOLA136SS	0 26715 24968 8	1	39.00	—	—	3.71	0.58	2.10	4.55	CT700	0 26715 19315 8	1	7.00	6	42.00	1.17	0.35	1.42	0.58
BOLA136WH	0 26715 24969 5	1	39.00	—	—	3.71	0.58	2.10	4.55	CVG4	7 84891 99490 6	1	0.29	6	1.74	0.52	0.52	0.23	0.06
BQSJ130BL	0 26715 24973 2	1	21.00	—	—	2.88	0.60	2.13	3.69	CVG6	7 84891 27070 3	1	0.50	6	3.00	0.63	0.63	0.25	0.10
BQSJ130SS	0 26715 24974 9	1	22.00	—	—	2.88	0.60	2.13	3.69	CV									

Model	UPC Code	Std. Carton		Master Carton		Length	Width	Height	Cube
		Pk.	Wt.	Pk.	Wt.				
DT4C	0 55321 16070 4	—	—	4	8.00	0.90	0.86	0.88	0.68
DT4W	0 55321 16067 4	1	6.25	—	—	2.27	0.69	0.69	1.07
DT6C	0 55321 16071 1	1	2.40	—	—	0.88	0.65	0.61	0.35
DT6W	0 55321 16068 1	1	8.10	—	—	2.46	0.84	0.81	1.67
E050	0 26715 25419 4	1	4.20	—	—	0.86	0.43	0.83	0.31
E070	0 26715 25421 7	1	4.60	—	—	0.86	0.43	0.83	0.31
E0F50	0 26715 25420 0	—	—	6	18.60	2.38	0.82	0.89	1.73
E0F70	0 26715 25423 1	—	—	6	21.00	2.38	0.82	0.89	1.73
E5490SS	0 26715 17438 6	1	87.00	—	—	3.40	2.50	1.90	16.15
E6030SS	0 26715 18624 2	1	70.00	—	—	3.50	2.00	2.79	19.54
E6036SS	0 26715 18625 9	1	74.00	—	—	3.50	2.00	2.79	19.54
E6042TSS	0 26715 18626 6	1	94.00	—	—	4.50	2.00	2.83	25.50
E6048TSS	0 26715 18627 3	1	94.00	—	—	4.50	2.00	2.83	25.50
E60E30SS	0 26715 18628 0	1	62.00	—	—	3.50	2.00	2.79	19.54
E60E36SS	0 26715 18629 7	1	67.00	—	—	3.51	2.00	2.79	19.59
E60E42SS	0 26715 18630 3	1	78.00	—	—	4.58	2.00	2.83	25.97
E60E48SS	0 26715 18631 0	1	82.00	—	—	4.58	2.00	2.83	25.97
E6430SS	0 26715 18632 7	1	43.60	—	—	3.32	1.13	2.23	8.33
E6436SS	0 26715 18633 4	1	46.90	—	—	3.30	1.13	2.18	8.17
E6442SS	0 26715 18634 1	1	53.40	—	—	4.33	1.15	2.25	11.21
E6448SS	0 26715 18635 8	1	55.50	—	—	4.33	1.15	2.25	11.21
E6448TSS	0 26715 18636 5	1	65.40	—	—	4.33	1.15	2.25	11.21
E64E30SS	0 26715 18637 2	1	35.60	—	—	3.31	1.13	2.25	8.37
E64E36SS	0 26715 18638 9	1	38.80	—	—	3.31	1.15	2.25	8.56
E64E42SS	0 26715 18639 6	1	45.00	—	—	4.33	1.15	2.25	11.21
E64E48SS	0 26715 18640 2	1	48.30	—	—	4.33	1.15	2.25	11.21
EH6	0 26715 05779 5	1	2.50	—	—	1.58	0.81	0.80	1.02
EI5936SS	0 26715 19491 9	1	88.00	—	—	3.27	2.44	1.80	14.36
EP300108	0 26715 06289 8	—	—	4	6.50	2.75	2.28	0.07	0.42
EP300223	0 26715 14094 7	—	—	4	6.00	2.75	2.29	0.07	0.42
EPD6136SS	0 26715 20406 9	1	91.00	—	—	3.50	2.00	2.79	19.54
EPD6142SS	7 72371 15040 9	1	109.00	—	—	4.50	2.00	2.83	25.50
EPD6148SS	0 26715 20407 6	1	110.00	—	—	4.58	2.00	2.83	25.97
EPD6160SS	0 26715 24005 0	1	145.00	—	—	6.50	2.00	2.83	36.83
EPLEC130SS	0 26715 24793 6	1	41.00	—	—	2.92	0.94	1.93	5.31
EPLEC136SS	0 26715 24794 3	1	44.00	—	—	3.40	0.94	1.94	6.17
EPLEC142SS	0 26715 24795 0	1	47.00	—	—	3.88	0.94	1.94	7.04
EPLEC148SS	0 26715 25222 0	1	51.00	—	—	4.42	0.94	1.92	7.97
EQLD130SS	0 26715 24981 7	1	39.00	—	—	3.38	0.60	2.13	4.33
EQLD136SS	0 26715 24982 4	1	43.00	—	—	3.75	0.61	2.15	4.90
ERV100S	0 26715 24255 9	1	41.00	—	—	2.36	1.04	2.08	5.12
ERV100SP	0 26715 24256 6	1	42.50	—	—	2.36	1.04	2.08	5.12
ERV110S	0 26715 24253 5	1	48.00	—	—	2.46	1.25	1.93	5.92
ERV110T	0 26715 24254 2	1	49.00	—	—	2.15	1.46	1.92	6.00
ERV120S	0 26715 24261 0	1	49.00	—	—	2.46	1.25	1.93	5.92
ERV120T	0 26715 24260 3	1	49.00	—	—	2.15	1.46	1.92	6.00
ERV130FLS	0 26715 25590 0	1	52.00	—	—	2.53	1.41	2.15	7.65
ERV140TE	0 26715 22803 4	1	57.00	—	—	2.23	1.48	2.27	7.49
ERV180S	0 26715 24265 8	1	67.00	—	—	3.38	1.74	1.67	9.80
ERV200TE	0 26715 24267 2	1	111.00	—	—	2.92	1.96	2.96	16.90
ERV250TE	0 26715 24269 6	1	97.00	—	—	2.90	1.93	3.03	16.86
ERV70S	0 26715 22801 0	1	37.00	—	—	1.94	1.52	1.60	4.73
ERV70T	0 26715 22800 3	1	36.00	—	—	1.79	1.52	1.54	4.20
ERVH100S	0 26715 24251 1	1	51.00	—	—	3.50	1.26	1.75	7.71
ERVS100S	0 26715 24257 3	1	40.85	—	—	2.34	1.03	2.10	5.05
EW5430BLS	0 26715 25367 8	1	56.00	—	—	2.86	1.83	2.46	12.88
EW5436BLS	0 26715 25368 5	1	61.00	—	—	3.33	1.83	2.46	15.02
EW5630SS	0 26715 19493 3	1	57.30	—	—	3.20	1.76	2.05	11.53
EW5636SS	0 26715 19492 6	1	60.00	—	—	3.19	1.76	2.07	11.60
EW5830SS	0 26715 19495 7	1	36.60	—	—	2.92	1.35	2.07	8.14
EW5836SS	0 26715 19494 0	1	40.00	—	—	3.40	1.37	2.10	9.76
EZ80N	0 26715 23143 0	1	9.60	—	—	1.53	0.54	1.15	0.95
F402401	0 26715 14293 4	1	11.60	—	—	2.25	0.64	1.63	2.35
F402404	0 26715 14295 8	1	12.00	—	—	2.25	0.64	1.63	2.35
F402408	0 26715 14296 5	1	11.60	—	—	2.25	0.64	1.63	2.35
F402411	0 26715 14460 0	1	11.60	—	—	2.25	0.64	1.63	2.35
F402422	0 26715 14461 7	1	11.90	—	—	2.25	0.64	1.63	2.35
F402423	0 26715 17319 8	1	11.60	—	—	2.25	0.64	1.63	2.35
F403001	0 26715 14297 2	1	12.60	—	—	2.75	0.63	1.63	2.79
F403004	0 26715 14299 6	1	13.30	—	—	2.75	0.65	1.63	2.90
F403008	0 26715 14300 9	1	12.90	—	—	2.75	0.64	1.63	2.87

Model	UPC Code	Std. Carton		Master Carton		Length	Width	Height	Cube
		Pk.	Wt.	Pk.	Wt.				
F403011	0 26715 14462 4	1	12.70	—	—	2.76	0.63	1.63	2.82
F403022	0 26715 14463 1	1	13.00	—	—	2.73	0.66	1.63	2.92
F403023	0 26715 14301 6	1	12.80	—	—	2.75	0.64	1.63	2.87
F403601	0 26715 14302 3	1	14.20	—	—	3.24	0.66	1.63	3.47
F403604	0 26715 14304 7	1	14.70	—	—	3.25	0.64	1.63	3.39
F403611	0 26715 14464 8	1	14.20	—	—	3.25	0.64	1.63	3.39
F403622	0 26715 14465 5	1	14.10	—	—	3.25	0.64	1.63	3.39
F403623	0 26715 14306 1	1	14.10	—	—	3.24	0.65	1.63	3.42
F404201	0 26715 14307 8	1	15.40	—	—	3.75	0.64	1.63	3.91
F404204	0 26715 14309 2	1	16.00	—	—	3.75	0.64	1.63	3.91
F404208	0 26715 14310 8	1	15.40	—	—	3.75	0.64	1.63	3.91
F404211	0 26715 14466 2	1	15.30	—	—	3.75	0.64	1.63	3.91
F404222	0 26715 14467 9	1	15.30	—	—	3.75	0.64	1.63	3.91
F404223	0 26715 17320 4	1	15.40	—	—	3.75	0.64	1.63	3.91
FG500N	0 26715 25653 2	—	—	4	6.68	0.92	0.88	1.04	0.84
FG500NS	0 26715 25859 8	1	1.40	—	—	1.00	0.98	0.21	0.20
FILTER59	0 26715 18717 1	1	1.10	—	—	0.82	0.08	0.86	0.05
FILTERE56	0 26715 19513 8	1	0.90	—	—	0.59	0.16	0.78	0.07
FILTERE56FL	0 26715 22857 7	1	0.95	—	—	1.88	0.83	0.10	0.16
FILTEREB40	0 26715 15235 3	1	1.90	5	9.50	0.74	0.30	0.74	0.16
FILTERECM	0 26715 25605 1	—	—	3	1.60	1.54	1.32	0.21	0.42
FILTERESQUARE	0 26715 15236 0	1	1.60	—	—	0.82	0.17	0.82	0.11
FIN-180B	0 26715 25558 0	1	14.40	—	—	2.25	1.23	1.29	3.56
FIN-180P	0 26715 25557 3	1	14.40	—	—	2.26	1.23	1.32	3.67
FIN-MERV13	0 26715 25561 0	—	—	10	6.00	1.67	0.88	0.92	1.34
FIN-MERV8	0 26715 25560 3	—	—	10	3.50	1.67	0.88	0.92	1.34
FIN-R1015	0 26715 25559 7	1	1.25	—	—	1.98	1.12	0.23	0.50
FX54SS	0 26715 17443 0	1	29.90	—	—	3.57	1.43	1.42	7.24
FXE54BLS	0 26715 25405 7	1	20.00	—	—	3.33	1.14	2.25	8.56
FXN53SS	0 26715 21090 9	1	9.00	—	—	3.00	1.10	1.17	3.86
FXN54SS	0 26715 17442 3	1	32.15	—	—	3.58	1.44	1.42	7.30
FXN56SS	0 26715 18749 2	1	8.90	—	—	2.89	1.11	1.19	3.82
FXN58SS	0 26715 18750 8	1	5.30	—	—	2.53	0.75	0.91	1.73
FXN59SS	0 26715 18748 5	1	18.50	—	—	3.20	1.12	1.13	4.05
FXNE56SS	0 26715 19515 2	1	18.60	—	—	3.89	1.09	1.08	4.60
FXNE58SS	0 26715 19516 9	1	12.90	—	—	3.00	0.85	1.01	2.57
FXNE59SS	0 26715 19514 5	1	38.10	—	—	3.09	1.09	1.08	3.66
FY6	7 84891 20698 6	1	1.90	—	—	1.16	0.56	1.11	0.72
G102	0 26715 02425 4	1	5.60	—	—	3.59	1.36	0.08	0.41
G103	0 26715 02426 1	1	8.00	—	—	4.29	1.54	0.08	0.55
G686N	0 26715 17886 5	—	—	4	2.00	0.84	0.82	0.28	0.19
GU10	0 26715 16883 5	—	—	10	1.25	0.68	0.62	0.20	0.08
GU1035	0 26715 19749 1	—	—	10	1.25	0.88	0.37	0.26	0.08
HAWWRK3	0 26715 25342 5	1	0.92	—	—	0.58	0.36	0.36	0.07
HCK44	0 26715 14603 1	—	—	10	5.00	1.98	0.64	0.82	1.03
HCK44D	0 26715 15148 6	—	—	50	17.50	1.24	0.78	0.81	0.79
HCR3	0 26715 25341 8	1	0.25	—	—	0.42	0.25	0.08	0.01
HD50RDF	0 26715 14609 3	—	—	4	16.80	1.83	1.03	0.99	1.87
HD80L	0 26715 05285 1	1	6.70	—	—	0.98	0.79	1.08	0.84
HLB11	0 26715 16924 5	1	68.00	—	—	2.17	1.83		

Model	UPC Code	Std. Carton		Master Carton		Length	Width	Height	Cube
		Pk.	Wt.	Pk.	Wt.				
HPFA436	0 26715 25054 7	1	4.97	—	—	1.48	1.39	0.31	0.63
HPFA442	0 26715 25055 4	1	6.25	—	—	1.40	0.32	1.73	0.77
HPFA52	0 26715 25056 1	—	—	2	1.00	1.40	0.32	0.98	0.44
HPFAMM30	0 26715 23682 4	—	—	3	3.78	1.40	0.30	1.27	0.54
HPFAMM36	0 26715 25057 8	—	—	2	3.40	1.40	0.28	1.49	0.59
HPFAMM42	0 26715 25058 5	—	—	2	5.70	1.38	0.32	1.74	0.76
HRKMBLS	0 26715 25601 3	1	20.00	—	—	3.35	1.13	2.25	8.54
HRV120S	0 26715 24259 7	1	43.00	—	—	2.46	1.25	1.93	5.92
HRV120T	0 26715 24258 0	1	43.00	—	—	2.15	1.46	1.92	6.00
HRV130FLS	0 26715 25589 4	1	49.00	—	—	2.53	1.42	2.13	7.66
HRV150FLS	0 26715 25267 1	1	64.00	—	—	3.06	1.73	1.71	9.06
HRV150S	0 26715 24262 7	1	63.00	—	—	3.04	1.73	1.70	8.94
HRV160T	0 26715 24263 4	1	53.30	—	—	2.27	1.48	2.29	7.71
HRV160TE	0 26715 24264 1	1	54.40	—	—	2.27	1.48	2.29	7.71
HRV190FLS	0 26715 25268 8	1	64.00	—	—	3.06	1.73	1.71	9.06
HRV190S	0 26715 24266 5	1	64.00	—	—	3.08	1.75	1.67	8.99
HRV200TE	0 26715 24268 9	1	130.00	—	—	2.92	1.96	2.96	16.90
HRV250TE	0 26715 24270 2	1	95.00	—	—	2.88	1.94	3.01	16.76
HRV80S	0 26715 24248 1	1	36.20	—	—	1.94	1.53	1.63	4.80
HRV80T	0 26715 24247 4	1	36.30	—	—	1.82	1.52	1.58	4.37
HRV90S	0 26715 24250 4	1	36.20	—	—	1.94	1.53	1.63	4.80
HRV90T	0 26715 24249 8	1	36.30	—	—	1.82	1.52	1.58	4.37
HRVH100S	0 26715 24252 8	1	50.85	—	—	3.48	1.27	1.75	7.72
HVRC1	0 26715 23595 7	1	0.35	—	—	0.40	0.36	0.37	0.05
HVRC4	0 26715 23596 4	1	0.60	—	—	0.40	0.36	0.37	0.05
ILF120	7 84891 20600 9	1	5.00	—	—	0.88	0.86	0.89	0.68
ILF130	7 84891 20610 8	1	4.80	—	—	0.88	0.86	0.88	0.66
ILF250	7 84891 20615 3	1	7.50	—	—	1.03	1.01	0.88	0.90
ILFK120	7 84891 20650 4	1	6.10	—	—	0.86	0.84	1.05	0.76
ILFK130	7 84891 20655 9	1	6.70	—	—	1.16	1.15	1.22	1.62
ILFK250	7 84891 20660 3	1	9.30	—	—	1.13	1.15	1.23	1.60
ILFK2502	7 84891 20665 8	1	12.10	—	—	1.67	1.16	1.17	2.25
ILRF	7 84891 20690 0	1	6.40	—	—	0.88	0.86	1.03	0.78
L100	0 26715 12449 7	1	18.90	—	—	1.33	1.25	1.33	2.22
L100L	0 26715 12459 6	1	19.10	—	—	1.33	1.25	1.33	2.22
L100MG	0 26715 12514 2	1	19.30	—	—	1.33	1.25	1.33	2.22
L150	0 26715 12450 3	1	19.30	—	—	1.33	1.25	1.33	2.22
L1500	0 26715 12458 9	1	58.00	—	—	2.17	1.83	1.92	7.61
L1500L	0 26715 12468 8	1	59.00	—	—	2.17	1.83	1.92	7.61
L150L	0 26715 12460 2	1	19.70	—	—	1.33	1.25	1.33	2.22
L150MG	0 26715 12515 9	1	19.70	—	—	1.33	1.25	1.33	2.22
L200	0 26715 12451 0	1	19.10	—	—	1.33	1.25	1.33	2.22
L2000L	0 26715 12469 5	1	87.50	—	—	3.25	1.38	1.50	6.70
L200L	0 26715 12461 9	1	19.50	—	—	1.33	1.25	1.33	2.22
L200MG	0 26715 12516 6	1	19.50	—	—	1.33	1.25	1.33	2.22
L250	0 26715 12452 7	1	21.00	—	—	1.33	1.25	1.33	2.22
L250L	0 26715 12462 6	1	21.40	—	—	1.34	1.24	1.33	2.22
L250MG	0 26715 12517 3	1	21.50	—	—	1.33	1.25	1.33	2.22
L300	0 26715 12453 4	1	21.00	—	—	1.33	1.25	1.33	2.22
L300KMG	0 26715 12519 7	1	22.40	—	—	1.33	1.25	1.33	2.22
L300L	0 26715 12463 3	1	21.40	—	—	1.33	1.25	1.33	2.22
L300MG	0 26715 12518 0	1	20.80	—	—	1.35	1.23	1.33	2.21
L3500EXL	0 26715 12470 1	1	142.00	—	—	3.90	1.58	1.71	10.55
L400	0 26715 12454 1	1	32.50	—	—	2.13	1.38	1.25	3.65
L400K	0 26715 12520 3	1	34.70	—	—	2.13	1.38	1.25	3.65
L400KL	0 26715 12512 8	1	34.80	—	—	2.13	1.38	1.25	3.65
L400L	0 26715 12464 0	1	32.10	—	—	2.13	1.38	1.25	3.65
L500	0 26715 12455 8	1	32.90	—	—	2.13	1.38	1.25	3.65
L500K	0 26715 12521 0	1	35.40	—	—	2.11	1.39	1.28	3.74
L500KL	0 26715 12513 5	1	36.00	—	—	2.13	1.38	1.25	3.65
L500L	0 26715 12465 7	1	33.10	—	—	2.13	1.38	1.25	3.65
L700	0 26715 12456 5	1	32.90	—	—	2.13	1.38	1.25	3.65
L700L	0 26715 12466 4	1	32.90	—	—	2.13	1.38	1.25	3.65
L900	0 26715 12457 2	1	58.70	—	—	2.16	1.83	1.89	7.49
L900L	0 26715 12467 1	1	57.50	—	—	2.16	1.84	1.89	7.52
LA100WH	7 84891 95195 4	—	—	3	4.13	0.64	0.55	0.71	0.25
LA107WH	7 84891 99129 5	1	1.90	3	5.70	0.24	0.63	0.79	0.12
LA11BG	7 84891 95188 6	—	—	6	7.88	1.25	0.76	0.53	0.50
LA11WH	7 84891 95187 9	—	—	6	7.88	1.25	0.73	0.53	0.49
LA126WH	7 84891 98008 4	1	1.40	6	8.40	0.68	0.21	0.53	0.07
LA130WH	7 84891 99134 9	1	1.55	6	9.30	0.65	0.21	0.51	0.07

Model	UPC Code	Std. Carton		Master Carton		Length	Width	Height	Cube
		Pk.	Wt.	Pk.	Wt.				
LA139WH	7 84891 99983 3	1	1.40	6	8.40	0.87	0.33	0.58	0.16
LA140WH	7 84891 99984 0	1	1.40	6	8.40	0.82	0.27	0.60	0.13
LA14WH	7 84891 95189 3	—	—	6	10.50	1.20	0.53	0.71	0.45
LA174WH	7 84891 02650 8	1	3.80	—	—	0.71	0.36	1.17	0.30
LA18WH	7 84891 95190 9	—	—	6	10.50	1.34	0.71	0.73	0.70
LA202WH	7 84891 95196 1	—	—	3	4.69	0.78	0.65	0.82	0.41
LA223WH	0 26715 23566 7	1	0.45	—	—	0.35	0.19	0.39	0.03
LA224RWH	0 26715 23570 4	1	0.45	3	1.35	0.28	0.22	0.40	0.02
LA224WH	0 26715 23568 1	1	0.55	3	1.65	0.40	0.22	0.33	0.03
LA225WH	0 26715 23564 3	1	0.35	3	1.05	0.35	0.11	0.38	0.01
LA226WH	0 26715 23565 0	1	1.60	3	4.80	0.58	0.21	0.66	0.08
LA227WH	0 26715 24889 6	1	18.74	50	936.95	1.50	1.15	0.72	1.24
LA305WL	7 84891 95185 5	1	7.20	—	—	1.03	1.80	0.50	0.93
LA310CY	7 84891 02731 4	1	6.70	—	—	1.76	1.28	0.67	1.50
LA39WH	7 84891 99333 6	1	2.60	3	7.80	0.65	0.23	0.89	0.14
LA542WH	0 26715 23571 1	—	—	3	2.90	0.65	0.57	0.81	0.30
LA552RW	0 26715 23572 8	1	2.25	—	—	0.90	0.34	0.69	0.21
LA553WH	0 26715 23567 4	—	—	3	4.70	0.86	0.76	0.77	0.50
LA600WH	0 26715 20681 0	1	1.45	6	8.70	1.02	0.73	0.30	0.22
LA70MA	7 84891 02320 0	1	6.00	—	—	1.42	1.12	0.58	0.92
LAF1	0 26715 13189 1	1	0.90	—	—	1.08	1.04	0.06	0.07
LAF2	0 26715 13190 7	1	1.30	—	—	1.81	1.03	0.08	0.16
LB30	0 26715 17299 3	1	7.90	—	—	2.55	0.44	1.50	1.69
LB30SS	0 26715 25622 8	1	9.00	—	—	2.55	0.44	1.50	1.69
LB36	0 26715 17300 6	1	9.90	—	—	2.97	0.42	1.53	1.89
LB36SS	0 26715 25623 5	1	11.00	—	—	2.97	0.42	1.53	1.89
LP110	0 26715 25651 8	1	10.10	—	—	1.40	0.52	1.17	0.84
LP110F	0 26715 25652 5	—	—	4	27.60	2.30	1.26	1.10	3.20
LP110H	0 26715 25654 9	—	—	4	16.00	1.19	1.18	1.53	2.15
LP80	0 26715 20347 5	1	9.20	—	—	1.39	0.50	1.15	0.80
LP80F	0 26715 23408 0	—	—	4	24.35	2.29	1.27	1.10	3.21
LP80H	0 26715 23410 3	—	—	4	16.60	1.19	1.19	1.53	2.16
LPN80	0 26715 20348 2	1	9.10	—	—	1.39	1.15	0.50	0.80
LPN80F	0 26715 23409 7	—	—	4	24.35	2.29	1.27	1.10	3.21
LT30	0 26715 17297 9	1	6.70	—	—	2.55	0.44	1.50	1.69
LT36	0 26715 17298 6	1	8.20	—	—	2.97	0.42	1.53	1.89
MCB2	0 26715 13906 4	1	1.10	—	—	1.28	0.21	0.15	0.04
MCV309NWHGL	7 84891 99194 3	—	—	6	5.63	0.88	0.63	0.76	0.42
MD10S	0 26715 21104 3	1	5.30	—	—	0.90	0.90	1.32	1.07
MD10T	0 26715 21103 6	1	6.95	—	—	0.90	0.90	1.32	1.07
MD10TU	0 26715 21102 9	1	6.95	—	—	0.90	0.90	1.32	1.07
MD6S	0 26715 20418 2	1	3.20	—	—	0.87	0.54	0.79	0.37
MD6T	0 26715 19203 8	1	4.30	—	—	0.87	0.54	0.79	0.37
MD6TU	0 26715 20378 9	1	4.70	—	—	0.87	0.54	0.79	0.37
MD8S	0 26715 20419 9	1	4.10	—	—	0.88	0.71	0.93	0.58
MD8T	0 26715 19204 5	1	5.30	—	—	0.88	0.71	0.93	0.58
MD8TU	0 26715 20379 6	1	5.60	—	—	0.88	0.71	0.95	0.59
MG1	0 26715 13196 9	1	2.30	—	—	1.19	1.18	0.08	0.12
MHB4	0 26715 23540 7	1	0.80	—	—	1.18	0.24	0.10	0.03
MMDC4	0 26715 23538 4	1	0.75	—	—	0.44	0.43	0.53	0.10
MMG	0 26715 23542 1	1	1.40	—	—	1.10	0.18	1.20	0.23

Model	UPC Code	Std. Carton		Master Carton		Length	Width	Height	Cube
		Pk.	Wt.	Pk.	Wt.				
PB41LBR	7 84891 05350 4	—	—	24	1.92	0.95	0.69	0.83	0.54
PB41LSN	7 84891 05351 1	—	—	24	2.40	0.96	0.71	0.82	0.55
PB41LBL	0 26715 17997 8	—	—	3	0.56	0.33	0.33	0.42	0.05
PB41LBR	0 26715 17989 3	—	—	3	0.56	0.33	0.33	0.42	0.05
PB41LSN	0 26715 17975 6	—	—	3	0.56	0.33	0.33	0.42	0.05
PB53LWH	0 26715 17995 4	—	—	3	0.75	0.33	0.33	0.42	0.05
PB61LPB	0 26715 17985 5	—	—	3	0.75	0.33	0.33	0.42	0.05
PB64LAB	0 26715 17992 3	—	—	3	0.56	0.33	0.33	0.42	0.05
PB69LBL	0 26715 17998 5	—	—	6	0.38	0.33	0.33	0.42	0.05
PB69LSN	0 26715 17977 0	—	—	6	0.38	0.33	0.33	0.42	0.05
PB78LWHCL	0 26715 21135 7	1	0.06	6	0.38	0.23	0.04	0.36	0.00
PB7LBL	7 84891 06001 4	—	—	12	0.60	0.33	0.33	0.42	0.05
PB7LPB	7 84891 06002 1	—	—	12	0.60	0.33	0.33	0.42	0.05
PB7LSN	7 84891 06003 8	—	—	12	0.60	0.33	0.33	0.42	0.05
PB7LWH	7 84891 06004 5	—	—	12	0.60	0.33	0.33	0.42	0.05
PB7WH	7 84891 06005 2	—	—	12	0.60	0.33	0.33	0.42	0.05
PB82WH	0 26715 23569 8	—	—	6	0.45	0.33	0.33	0.42	0.05
PB85BR	0 26715 23573 5	—	—	6	1.20	0.33	0.33	0.42	0.05
PB85SN	0 26715 23590 2	—	—	6	1.20	0.33	0.33	0.42	0.05
PBL2	7 84891 99073 1	—	—	12	0.30	0.53	0.52	0.39	0.11
PM250	0 26715 17295 5	1	8.80	—	—	1.91	0.58	1.19	1.31
PM250SSP	0 26715 25409 5	1	9.40	—	—	1.91	0.58	1.19	1.31
PM390	0 26715 17296 2	1	18.80	—	—	2.00	1.13	1.25	2.81
PM390SSP	0 26715 25621 1	1	19.80	—	—	2.00	1.13	1.25	2.81
PM500SS	0 26715 17229 0	1	23.40	—	—	2.29	1.30	1.42	4.22
PME300	0 26715 19991 4	1	23.60	—	—	2.00	1.13	1.25	2.81
PP500	0 26715 23561 2	1	22.65	—	—	1.38	1.25	2.65	4.55
PP600	0 26715 23562 9	1	26.85	—	—	1.40	1.25	3.25	5.67
PP650	0 26715 23563 6	1	29.60	—	—	1.38	1.25	3.36	5.77
QT9093WH	7 84891 32212 9	1	23.50	—	—	1.96	1.61	1.04	3.28
QTHB1	0 26715 17278 8	1	1.50	—	—	1.38	0.38	0.29	0.15
QTNLEDA	0 26715 19949 5	1	13.60	—	—	1.32	1.30	1.24	2.13
QTNLEDB	0 26715 19950 1	1	13.80	—	—	1.32	1.23	1.29	2.08
QTX110HFLT	0 26715 18797 3	1	22.80	—	—	1.76	1.35	1.33	3.16
QTX110HL	0 26715 16389 2	1	22.60	—	—	1.76	1.35	1.33	3.16
QTXE080	0 26715 16375 5	1	11.60	—	—	1.29	0.95	1.33	1.64
QTXE080FLT	0 26715 17177 4	1	13.05	—	—	1.30	1.29	1.18	1.99
QTXE110	0 26715 16377 9	1	10.70	—	—	1.33	0.95	1.29	1.64
QTXE110FLT	0 26715 17178 1	1	12.00	—	—	1.30	1.29	1.18	1.99
QTXE110S	0 26715 16415 8	1	12.15	—	—	1.33	0.95	1.29	1.64
QTXE150	0 26715 16379 3	1	11.70	—	—	1.33	0.93	1.27	1.58
QTXE150FLT	0 26715 17179 8	1	13.10	—	—	1.33	1.18	1.29	2.01
QTXEN080	7 84891 21825 5	1	11.60	—	—	1.29	0.96	1.28	1.58
QTXEN080FLT	7 84891 21530 8	1	12.90	—	—	1.30	1.29	1.18	1.99
QTXEN110	7 84891 21827 9	1	10.70	—	—	1.29	0.96	1.28	1.58
QTXEN110FLT	7 84891 21531 5	1	12.00	—	—	1.30	1.29	1.18	1.99
QTXEN150	7 84891 21829 3	1	11.60	—	—	1.32	0.96	1.29	1.63
QTXEN150FLT	7 84891 21532 2	1	13.00	—	—	1.32	1.28	1.23	2.08
QTXN110HFLT	0 26715 18798 0	1	22.70	—	—	1.75	1.35	1.33	3.15
QTXN110HL	7 84891 21848 4	1	22.60	—	—	1.75	1.35	1.33	3.15
RB110	0 26715 23005 1	1	13.50	—	—	1.17	1.25	0.96	1.40
RB110L1	0 26715 25479 8	1	14.46	—	—	1.25	1.17	0.98	1.42
RB80	0 26715 23004 4	1	14.50	—	—	1.17	1.25	0.96	1.40
RB80L1	0 26715 25480 4	1	14.38	—	—	1.25	1.17	0.98	1.42
RBFIIP33	0 26715 15797 6	1	6.90	—	—	1.29	0.70	1.15	1.04
RBFIIP45	0 26715 15798 3	1	9.60	—	—	1.28	0.71	1.15	1.05
RD1	0 26715 12474 9	1	4.10	—	—	1.09	0.37	1.08	0.43
RD2	0 26715 12475 6	1	4.80	—	—	1.87	1.10	0.37	0.75
RD3	0 26715 12476 3	1	6.40	—	—	1.90	1.58	0.37	1.10
RDF1	0 26715 20166 2	1	4.90	—	—	1.12	1.03	0.42	0.48
RDFQF	0 26715 23481 3	1	2.15	—	—	0.98	0.91	0.21	0.19
RDFQL	0 26715 23480 6	1	3.30	—	—	0.98	0.98	0.21	0.20
RDFU	0 26715 23479 0	1	3.75	—	—	1.00	0.97	0.33	0.31
RDFUWT	0 26715 25092 9	1	5.55	—	—	1.04	1.01	0.50	0.53
RDH	0 26715 14608 6	—	—	4	22.40	1.75	0.88	1.54	2.36
RDJ1	0 26715 19962 4	1	4.80	—	—	1.03	0.86	0.48	0.43
RDJUMPO	0 26715 23483 7	1	0.03	—	—	0.50	0.42	0.02	0.00
RDJUMPU	0 26715 23482 0	1	0.10	—	—	0.48	0.21	0.08	0.01
RDJUMPU1	0 26715 25445 3	1	0.05	—	—	0.63	0.27	0.04	0.01
RDM1	0 26715 23541 4	1	3.45	—	—	0.96	0.93	0.29	0.26
RDMWT	0 26715 25093 6	1	6.50	—	—	0.98	0.98	0.80	0.77

Model	UPC Code	Std. Carton		Master Carton		Length	Width	Height	Cube
		Pk.	Wt.	Pk.	Wt.				
RFTH95	7 84891 31095 9	1	0.70	—	—	0.39	0.37	0.20	0.03
RFX5001	0 26715 15846 1	1	13.30	—	—	3.25	0.84	0.84	2.30
RFX5004	0 26715 15806 1	1	7.60	—	—	3.25	0.87	0.80	2.25
RFX5023	0 26715 15847 8	1	8.00	—	—	3.25	0.84	0.84	2.30
RFX5104	0 26715 15091 5	1	11.50	—	—	3.28	1.11	1.18	4.28
RFX5204	0 26715 15096 0	1	11.80	—	—	3.28	1.11	1.18	4.28
RFX5304	0 26715 16522 3	1	18.00	—	—	3.57	1.43	1.42	7.24
RFX6104	0 26715 15182 0	1	9.30	—	—	3.04	1.04	0.98	3.09
RFX6104EX	0 26715 15183 7	1	16.25	—	—	3.57	1.43	1.42	7.24
RFX6304EX	0 26715 15636 8	1	32.90	—	—	3.57	1.43	1.42	7.24
RFXN5004	0 26715 17205 4	1	7.30	—	—	3.25	0.87	0.80	2.25
RFXN5204	0 26715 17206 1	1	10.20	—	—	3.28	1.11	1.18	4.28
RFXN5304	0 26715 16523 0	1	15.10	—	—	3.57	1.43	1.42	7.24
RG4	7 84891 00517 6	—	—	12	3.60	1.06	0.86	0.27	0.24
RK54	0 26715 17440 9	1	4.50	—	—	1.48	0.89	0.90	1.18
RK56	0 26715 18787 4	1	5.50	—	—	1.58	0.80	0.93	1.18
RK58	0 26715 18788 1	1	5.20	—	—	1.57	0.79	0.93	1.15
RK59	0 26715 18786 7	1	5.10	—	—	1.64	0.75	0.99	1.22
RKE56	0 26715 19518 3	1	7.10	—	—	2.12	0.57	1.42	1.70
RKE58	0 26715 19519 0	1	7.00	—	—	2.12	0.60	1.14	1.45
RKE59	0 26715 19517 6	1	6.60	—	—	2.12	0.63	1.34	1.77
RM503001	0 26715 15813 3	1	36.70	—	—	2.82	1.51	2.03	8.64
RM503004	0 26715 14948 3	1	35.70	—	—	2.79	1.54	2.03	8.72
RM503023	0 26715 15814 0	1	36.70	—	—	2.81	1.54	2.03	8.80
RM503601	0 26715 15815 7	1	40.80	—	—	3.19	1.50	2.04	9.77
RM503604	0 26715 14949 0	1	38.10	—	—	3.19	1.50	2.04	9.77
RM503623	0 26715 15816 4	1	38.20	—	—	3.19	1.50	2.04	9.77
RM519004	0 26715 15089 2	1	37.45	—	—	3.19	1.50	2.04	9.77
RM523004	0 26715 15092 2	1	41.50	—	—	2.81	1.54	2.03	8.80
RM523604	0 26715 15093 9	1	42.80	—	—	3.17	1.53	2.04	9.86
RM524204	0 26715 15094 6	1	45.60	—	—	3.75	1.58	2.03	12.02
RM533004	0 26715 16519 3	1	46.10	—	—	2.81	1.54	2.03	8.80
RM533604	0 26715 16520 9	1	48.00	—	—	3.19	1.50	2.04	9.77
RM534204	0 26715 16521 6	1	52.00	—	—	3.75	1.58	2.04	12.12
RM659004	0 26715 15087 8	1	56.80	—	—	3.40	1.81	2.23	13.73
RMDD3004	0 26715 15178 2	1	66.20	—	—	2.83	2.90	0.90	7.39
RMDD3004EX	0 26715 15178 3	1	53.60	—	—	2.83	2.91	0.90	7.42
RMDD3604	0 26715 15176 9	1	72.70	—	—	3.33	2.89	0.90	8.67
RMDD3604EX	0 26715 15179 0	1	61.80	—	—	3.33	2.91	0.89	8.64
RMDD4804	0 26715 15177 6	1	96.00	—	—	4.33	2.92	0.92	11.59
RMDD4804EX	0 26715 15180 6	1	77.00	—	—	4.33	2.92	0.92	11.59
RMDDRKB	0 26715 15181 3	1	0.30	—	—	0.40	0.35	0.35	0.05
RME5030S	0 26715 19889 4	1	36.10	—	—	2.80	1.53	2.03	8.68
RMIP33	0 26715 15784 6	1	32.50	—	—	3.31	1.16	2.20	8.43
RMIP45	0 26715 15785 3	1	41.80	—	—	4.33	1.15	2.25	11.21
RMIPWC	0 26715 15796 9	1	1.60	—	—	0.68	0.53	0.41	0.15
RML3336S	0 26715 16367 0	1	10.70	—	—	3.67	2.25	0.42	3.44
RML3342S	0 26715 16368 7	1	14.10	—	—	4.67	2.25	0.42	4.37
RML4548S	0 26715 16369 4	1	13.30	—	—	4.67	2.25	0.42	4.37
RML4554S	0 26715 17282 5	1	18.20	—	—	6.67	2.25	0.42	6.25
RML4560S	0 26715 16370 0	1	19.10	—					

Model	UPC Code	Std. Carton		Master Carton		Length	Width	Height	Cube
		Pk.	Wt.	Pk.	Wt.				
RN80L	0 26715 23010 5	1	14.60	—	—	1.24	1.15	1.21	1.73
ROUNDFILTER	0 26715 08370 1	1	1.75	—	—	0.74	0.30	0.74	0.16
RRK51	0 26715 15090 8	1	3.70	—	—	1.48	0.89	0.90	1.18
RVK1A	0 26715 15782 2	1	2.90	—	—	1.00	0.46	0.94	0.43
S97011308	0 26715 05311 7	1	1.00	—	—	1.03	0.88	0.06	0.05
S97013825	0 26715 10088 0	1	3.55	—	—	1.27	1.23	0.23	0.36
S97013826	0 26715 10089 7	1	2.35	—	—	1.07	1.02	0.16	0.17
S97013827	0 26715 10090 3	1	3.45	—	—	1.26	1.24	0.23	0.35
S99010042	0 26715 03239 6	1	0.10	—	—	0.79	0.79	0.01	0.01
S99010271	0 26715 07821 9	1	0.10	—	—	0.87	0.87	0.01	0.01
S990712044	0 26715 13553 0	1	0.10	—	—	0.35	0.29	0.00	0.00
SMD6	0 26715 19201 4	1	4.80	—	—	0.87	0.54	0.79	0.37
SMD8	0 26715 19202 1	1	5.50	—	—	0.85	0.84	0.69	0.49
SMSCPLR	0 26715 18621 1	1	0.40	—	—	0.43	0.24	0.30	0.03
SP240108	0 26715 06279 9	1	3.10	—	—	2.75	2.28	0.07	0.42
SP240223	0 26715 14089 3	1	3.10	—	—	2.75	2.29	0.07	0.42
SP2404	0 26715 02218 2	1	4.60	—	—	2.75	2.29	0.07	0.42
SP300108	0 26715 06281 2	1	3.10	—	—	2.75	2.29	0.07	0.42
SP300223	0 26715 14090 9	1	3.10	—	—	2.75	2.29	0.07	0.42
SP3004	0 26715 00076 0	1	6.00	—	—	2.75	2.29	0.07	0.42
SP360108	0 26715 06283 6	1	3.70	—	—	3.75	2.29	0.07	0.57
SP360223	0 26715 14091 6	1	3.40	—	—	3.75	2.29	0.07	0.57
SP3604	0 26715 00077 7	1	7.60	—	—	3.75	2.29	0.07	0.57
SP420108	0 26715 06285 0	1	3.90	—	—	3.92	2.29	0.07	0.60
SP420223	0 26715 14092 3	1	3.70	—	—	3.75	2.29	0.07	0.57
SP4204	0 26715 02228 1	1	7.30	—	—	3.75	2.29	0.07	0.57
SPB18LWHCL	0 26715 23790 6	1	0.02	—	—	0.25	0.15	0.08	0.00
SPK110	0 26715 23412 7	1	12.05	—	—	1.29	0.94	1.31	1.59
SPKACC	0 26715 23414 1	1	2.10	—	—	1.06	0.53	0.53	0.30
SSQTXE080	0 26715 18620 4	1	12.00	—	—	1.29	0.96	1.33	1.65
SSQTXE110	0 26715 18619 8	1	12.15	—	—	0.97	1.29	1.33	1.66
T457	0 26715 25209 1	1	1.27	—	—	0.90	0.88	0.67	0.52
T460	0 26715 16881 1	1	2.00	—	—	1.30	0.77	0.67	0.66
T461	0 26715 16882 8	1	0.80	8	6.40	1.27	0.44	0.50	0.28
T486	0 26715 22964 2	1	1.50	—	—	0.79	0.79	0.67	0.42
T487	0 26715 20786 2	1	1.40	—	—	0.75	0.77	0.71	0.41
T81212	0 26715 13195 2	1	4.00	—	—	1.09	1.09	0.99	1.18
V104	0 26715 02700 2	—	—	4	2.20	0.40	0.39	0.31	0.05
V14695	7 72371 13701 1	1	12.10	—	—	1.73	1.31	0.98	2.23
V21030	7 72371 13707 3	1	0.10	—	—	0.83	0.64	0.06	0.03
V21996	0 26715 25200 8	1	1.45	—	—	1.53	1.03	0.40	0.62
V22528	0 26715 25199 5	1	1.65	—	—	1.53	1.03	0.40	0.62

Model	UPC Code	Std. Carton		Master Carton		Length	Width	Height	Cube
		Pk.	Wt.	Pk.	Wt.				
V61239	7 72371 13900 8	1	0.85	—	—	0.60	0.57	0.22	0.07
VACCWMK	7 72371 13721 9	1	1.50	—	—	2.07	0.19	0.18	0.07
VB20W	0 26715 10282 2	1	0.25	—	—	0.65	0.53	0.19	0.06
VB60W	0 26715 24317 4	1	0.20	—	—	0.42	0.27	0.08	0.01
VS63WH	7 84891 27434 3	1	0.40	6	2.40	0.40	0.24	0.18	0.02
VS66WH	7 84891 27465 7	1	0.60	6	3.60	0.26	0.40	0.44	0.05
VS68WH	7 84891 27485 5	1	0.70	6	4.20	0.43	0.25	0.42	0.04
VT10W	0 26715 24316 7	1	0.55	—	—	0.44	0.44	0.17	0.03
VT11W	0 26715 25556 6	1	0.35	—	—	0.64	0.52	0.19	0.06
VT1W	0 26715 10283 9	1	0.70	—	—	0.20	0.53	0.67	0.07
VT4W	0 26715 17041 8	1	0.30	—	—	0.52	0.20	0.67	0.07
VT6W	0 26715 24312 9	1	0.55	—	—	0.44	0.44	0.17	0.03
VT7W	0 26715 24313 6	1	0.30	—	—	0.42	0.30	0.13	0.02
VT8W	7 72371 13553 6	1	0.50	—	—	0.38	0.36	0.13	0.02
VT9W	7 72371 13503 1	1	0.25	—	—	0.30	0.13	0.43	0.02
VTYK1	7 72371 13722 6	1	4.55	—	—	2.08	1.58	0.71	2.34
VX1000	7 84891 77156 9	1	41.40	—	—	1.68	1.35	3.50	7.91
VX1000C	7 84891 77157 6	1	41.50	—	—	1.68	1.34	3.50	7.90
VX3916	7 84891 77669 4	1	0.62	6	3.72	1.00	0.48	0.21	0.10
VX3918	7 84891 77670 0	1	0.88	6	5.28	0.90	0.60	0.19	0.10
VX3918STD	7 84891 77671 7	1	0.77	12	9.24	0.94	0.50	0.19	0.09
WC638	0 26715 17212 2	1	3.30	—	—	1.38	0.89	0.56	0.69
WC650	0 26715 18023 3	—	—	4	2.00	1.21	1.15	0.21	0.29
WVK2A	0 26715 18024 0	1	1.10	—	—	0.88	0.59	0.59	0.31
XB110	0 26715 20115 0	1	12.20	—	—	1.24	1.17	0.97	1.40
XB110H	0 26715 20287 4	1	12.30	—	—	1.25	1.15	0.96	1.38
XB110HL1	0 26715 25253 4	1	13.60	—	—	1.23	1.15	0.96	1.36
XB110L1	0 26715 25251 0	1	13.15	—	—	1.23	1.15	0.96	1.36
XB50	0 26715 20119 8	1	12.50	—	—	1.23	1.15	0.96	1.36
XB50L1	0 26715 25247 3	1	13.70	—	—	1.23	1.17	0.96	1.38
XB80	0 26715 20117 4	1	12.10	—	—	1.23	1.16	0.97	1.38
XB80L1	0 26715 25249 7	1	13.40	—	—	1.23	1.15	0.96	1.36
ZB110	0 26715 20107 5	1	11.90	—	—	1.25	1.17	0.97	1.41
ZB110H	0 26715 20286 7	1	12.40	—	—	1.23	1.15	0.94	1.34
ZB110HL1	0 26715 25261 9	1	13.55	—	—	1.23	1.15	0.96	1.36
ZB110L1	0 26715 25259 6	1	13.10	—	—	1.23	1.15	0.96	1.36
ZB110M	0 26715 20288 1	1	12.30	—	—	1.23	1.14	0.95	1.33
ZB110ML1	0 26715 25263 3	1	13.55	—	—	1.23	1.15	0.96	1.36
ZB80	0 26715 20109 9	1	12.00	—	—	1.23	1.15	0.98	1.39
ZB80L1	0 26715 25255 8	1	13.70	—	—	1.23	1.17	0.96	1.38
ZB80M	0 26715 20289 8	1	12.60	—	—	1.23	1.16	0.96	1.37
ZB80ML1	0 26715 25257 2	1	13.80	—	—	1.23	1.15	0.96	1.36

All sales are governed by the Terms and Conditions available at <http://salesterms.broan-nutone.com>. Buyer's additional or different terms are hereby rejected.

